

# **USER'S MANUAL**

**BM-0942**

**Mini-ITX Motherboard  
with Intel® 4<sup>th</sup> Gen. Core™ i7/i5  
features 2 LAN/2DVI/4COM**

**BM-0942 M1**

---

---

***BM-0942***  
***With Intel<sup>®</sup> 4<sup>th</sup> Gen. Core<sup>™</sup>***  
***Mini-ITX Motherboard***

**COPYRIGHT NOTICE & TRADEMARK**

All trademarks and registered trademarks mentioned herein are the property of their respective owners.

This manual is copyrighted in Jan. 2014. You may not reproduce or transmit in any form or by any means, electronic, or mechanical, including photocopying and recording.

**DISCLAIMER**

This operation manual is meant to assist both Embedded Computer manufacturers and end users in installing and setting up the system. The information contained in this document is subject to change without any notice.

**CE NOTICE**

This is a class A product. In a domestic environment this product may cause radio interference in which case the user may be required to take adequate measures.

---

---

---

---

## FCC NOTICE

This equipment has been tested and found to comply with the limits for a Class A digital device, pursuant to part 15 of the FCC Rules. These limits are designed to provide reasonable protection against harmful interference when the equipment is operated in a commercial environment. This equipment generates, uses, and can radiate radio frequency energy and, if not installed and used in accordance with the instruction manual, may cause harmful interference to radio communications. Operation of this equipment in a residential area is likely to cause harmful interference in which case the user will be required to correct the interference at his own expense.

You are cautioned that any change or modifications to the equipment not expressly approve by the party responsible for compliance could void your authority to operate such equipment.

**CAUTION!** Danger of explosion if battery is incorrectly replaced. Replace only with the same or equivalent type recommended by the manufacturer. Dispose of used batteries according to the manufacturer's instructions.

---

---

## TABLE OF CONTENTS

### CHAPTER 1 INTRODUCTION

1-1	About This Manual.....	1-2
1-2	System Specification.....	1-3
1-3	Safety Precautions.....	1-5

### CHAPTER 2 HARDWARE CONFIGURATION

2-1	Jumper & Connector Quick Reference Table.....	2-2
2-2	Component Locations.....	2-3
2-3	How to Set Jumpers.....	2-5
2-4	COM Port.....	2-7
2-5	COM Connector.....	2-8
2-6	Keyboard & Mouse Port.....	2-8
2-7	DVI Port.....	2-9
2-8	LAN & USB Port.....	2-10
2-9	Audio Jack.....	2-12
2-10	COM Port RI & Voltage Selection.....	2-13
2-11	COM2 RS-232/422/485 Selection.....	2-14
2-12	COM2 Auto-detect Selection.....	2-14
2-13	Front Panel Connector & Selection.....	2-15
2-14	Intel® ME Selection.....	2-16
2-15	Clear CMOS Data Selection.....	2-17
2-16	BIOS Recovery Mode Selection.....	2-17
2-17	Fan Connector.....	2-18
2-18	SATA Connector.....	2-18
2-19	USB Connector.....	2-19
2-20	Display Port Connector.....	2-19
2-21	ATX Power Connector.....	2-20

### CHAPTER 3 SOFTWARE UTILITIES

3-1	Introduction.....	3-2
3-2	Intel® Chipset Software Installation Utility.....	3-4

---

3-3	Intel® Rapid Storage Technology Utility.....	3-5
3-4	Intel® USB3.0 eXtensible Host Controller Utility.....	3-6
3-5	Intel® Management Engine Components Utility.....	3-7
3-6	VGA Driver Utility.....	3-8
3-7	LAN Driver Utility.....	3-9
3-8	Sound Driver Utility.....	3-10

## **CHAPTER 4 BIOS SETUP**

4-1	Introduction.....	4-2
4-2	Entering Setup.....	4-4
4-3	Main.....	4-6
4-4	Advanced.....	4-7
4-5	Chipset.....	4-27
4-6	Boot.....	4-40
4-7	Security.....	4-45
4-8	Save & Exit.....	4-48

## **APPENDIX A EXPANSION BUS**

PCIe Bus.....	A-2
---------------	-----

## **APPENDIX B TECHNICAL SUMMARY**

Block Diagram.....	B-2
Interrupt Map.....	B-3
DMA Channels Map.....	B-8
I/O Map.....	B-9
Memory Map.....	B-12
Watchdog Timer Configuration.....	B-14
Flash BIOS Update.....	B-17

---

---

# *INTRODUCTION*

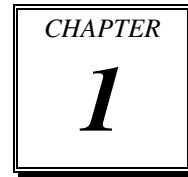

This chapter gives you the information for BM-0942. It also outlines the system specifications.

Sections included:

- About This Manual
- System Specifications
- Safety Precautions

**Experienced users can jump to chapter 2 on page 2-1 for a quick start.**

## **1-1. ABOUT THIS MANUAL**

Thank you for purchasing our BM-0942 Mini-ITX Motherboard with Intel® 4<sup>th</sup> Gen. Core™ i7/i5 processor, Intel® H81/Q87 chipset, 2LAN/2DVI/4COM, which is fully PC/AT compatible. The BM-0942 provides faster processing speed, greater expandability and can handle more tasks than before. This manual is designed to assist you how to install and set up the system. It contains four chapters. The user can apply this manual for configuration according to the following chapters:

### ***Chapter 1 Introduction***

This chapter introduces you to the background of this manual, and the specifications for this system. The final page of this chapter will indicate how to avoid damaging this board.

### ***Chapter 2 Hardware Configuration***

This chapter outlines the component locations and their functions. In the end of this chapter, you will learn how to set jumper and how to configure this card to meet your own needs.

### ***Chapter 3 Software Utilities***

This chapter contains helpful information for proper installations of the VGA utility, LAN utility, Sound utility, and Flash BIOS Update. It also describes the Watchdog-timer configuration.

### ***Chapter 4 BIOS Setup***

This chapter indicates you how to set up the BIOS configurations.

### ***Appendix A Expansion Bus***

This appendix introduces you the expansion bus for PCIe connectors.

### ***Appendix B Technical Summary***

This appendix gives you the information about the Technical maps.

## 1-2. SYSTEM SPECIFICATIONS

### System

CPU	Intel® 4 <sup>th</sup> Gen. Core™ i5/i7 Processor (LGA1150) <ul style="list-style-type: none"> <li>▪ i5-4570S (65W)</li> <li>▪ i5-4570TE (35W)</li> <li>▪ i7-4770S (65W)</li> </ul>
OS Support	Windows 8, 7
Chipset	Intel® H81/Q87
Memory	2 x SO-DIMM (204 pins), dual channel DDR3-1333/1600 MHz, up to 16GB
BIOS	AMI
Watchdog	1~255 seconds
Power Supply	ATX 12V & 5VSB (24-pin connector; 4-pin connector for CPU)
Dimension	170 x 170 mm (6.69" x 6.69")
Certificate	CE/FCC

### I/O Ports

Serial Port	4 ports: <ul style="list-style-type: none"> <li>▪ COM1/2: D-sub, +5V/+12V/RI selectable</li> <li>▪ COM3/4: Box headers on board (COM1/3/4 for RS-232, COM2 for RS-232/422/485)</li> </ul>
USB Port	<ul style="list-style-type: none"> <li>▪ 2 x external USB 3.0, stacked with LAN</li> <li>▪ 6 x USB 2.0 (2 are external &amp; stacked with LAN, 4 are internal pin-headers.)</li> </ul>
SATA Interface	<ul style="list-style-type: none"> <li>▪ Intel® H81: 1 x SATA II, 2 x SATA III</li> <li>▪ Intel® Q87: 3 x SATA III</li> </ul>
LAN	Dual ports, support Wake-on-LAN <ul style="list-style-type: none"> <li>▪ LAN1: Intel® I217-LM/V</li> <li>▪ LAN2: Intel® I210-AT</li> </ul>
Audio	<ul style="list-style-type: none"> <li>▪ Realtek ALC888S-VD2-GR High Definition audio codec Line-in/Line-out/MIC</li> <li>▪ Option: S/PDIF</li> </ul>
Keyboard/Mouse	1 x PS/2
Expansion Bus	1 x PCIe (16x) Gen. 2



**Display**

Graphics	Built-in processor to share the system memory. <ul style="list-style-type: none"><li>▪ 1 x DVI-I</li><li>▪ 1 x DVI-D</li><li>▪ 1 x Display Port</li></ul>
----------	---

**Environment**

Operating Temp.	0 ~ 60°C (32 ~ 140°F)
Storage Temp.	-40 ~ 80°C (-40 ~ 176°F)
Humidity	Operating: 5~90% (non-condensing)

### **1-3. SAFETY PRECAUTIONS**

Follow the messages below to avoid your systems from damage:

1. Keep your system away from static electricity on all occasions.
2. Prevent electric shock. Don't touch any components of this card when the card is power-on. Always disconnect power when the system is not in use.
3. Disconnect power when you change any hardware devices.  
For instance, when you connect a jumper or install any cards, a surge of power may damage the electronic components or the whole system.

# ***HARDWARE CONFIGURATION***

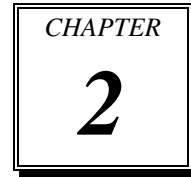

## **\*\* *QUICK START* \*\***

Helpful information describes the jumper & connector settings, and component locations.

Sections included:

- Jumper & Connector Quick Reference Table
- Component Locations
- Configuration and Jumper settings
- Connector's Pin Assignments

**2-1. JUMPER & CONNECTOR QUICK REFERENCE TABLE**

<b>JUMPER/CONNECTOR</b>	<b>NAME</b>
COM Port	COM1, COM2
COM Connector	COM3, COM4
Keyboard & Mouse Port	KB_MS1
DVI Port	DVI1
LAN & USB Port	LAN1_USB1, LAN2_USB2
Audio Jack	AUDIO1
COM Port RI & Voltage Selection	JP_COM1, JP_COM2
COM2 RS-232/422/485 Selection	JP8
COM2 Auto-detect Selection	JP7
Front Panel Connector & Selection	FP1
Intel® ME Selection	JP3
Clear CMOS Data Selection	JP4
BIOS Recovery Mode Selection	JP1
Fan Connector	CPU_FAN1, SYS_FAN1, SYS_FAN2
SATA Connector	SATA1, SATA2, SATA3
USB Connector	USB3, USB4
Display Port Connector	DP1
ATX Power Connector	ATX_PWR1, ATX_PWR2

## 2-2. COMPONENT LOCATIONS

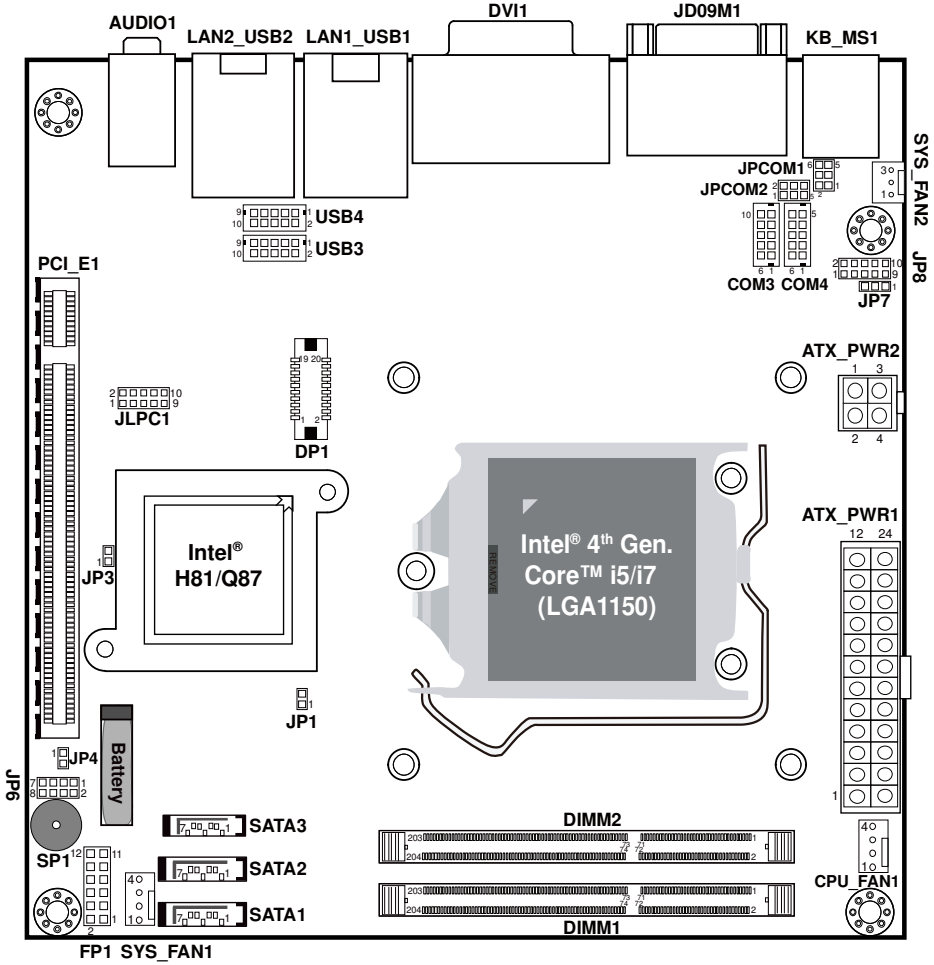

BM-0942 Front Connector, Jumper and Component locations

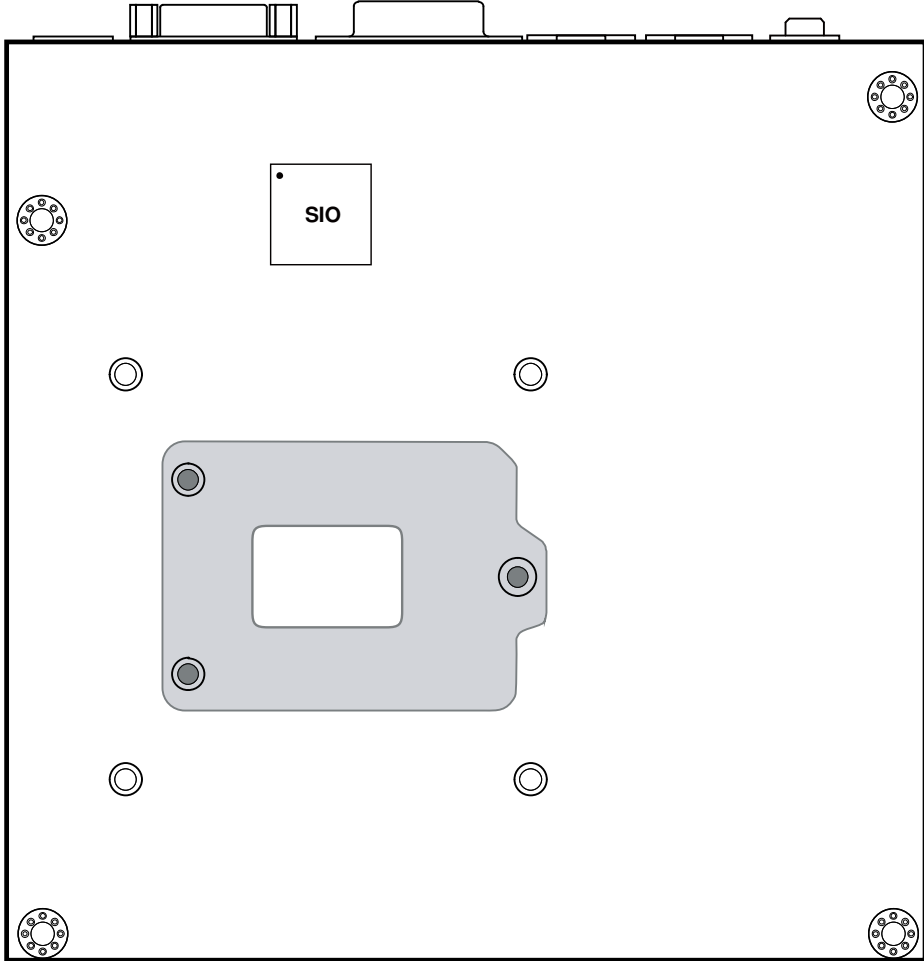

BM-0942 Rear Component locations

## 2-3. HOW TO SET JUMPERS

You can configure your board by setting jumpers. Jumper is consists of two or three metal pins with a plastic base mounted on the card, and by using a small plastic "cap", Also known as the jumper cap (with a metal contact inside), you are able to connect the pins. So you can set-up your hardware configuration by "open" or "close" pins.

The jumper can be combined into sets that called jumper blocks. When the jumpers are all in the block, you have to put them together to set up the hardware configuration. The figure below shows how this looks like.

### JUMPERS AND CAPS

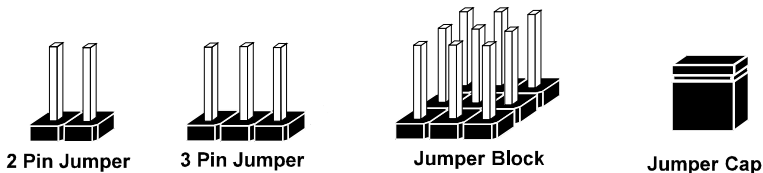

If a jumper has three pins (for examples, labelled PIN1, PIN2, and PIN3), You can connect PIN1 & PIN2 to create one setting by shorting. You can either connect PIN2 & PIN3 to create another setting. The same jumper diagrams are applied all through this manual. The figure below shows what the manual diagrams look and what they represent.

**Jumper Diagrams**



**Jumper Cap**  
looks like this

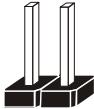

**2 pin Jumper**  
looks like this

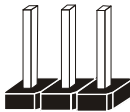

**3 pin Jumper**  
looks like this



**Jumper Block**  
looks like this

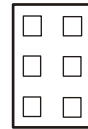

**Jumper Settings**



**2 pin Jumper close(enabled)**  
Looks like this



**3 pin Jumper**  
**2-3 pin close(enabled)**  
Looks like this

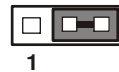

**Jumper Block**  
**1-2 pin close(enabled)**  
Looks like this

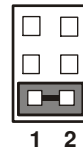



## 2-4. COM PORT

**COM1:** COM Port, fixed as RS-232

PIN	ASSIGNMENT	PIN	ASSIGNMENT
1	DCD#	6	DSR#
2	RX	7	RTS#
3	TX	8	CTS#
4	DTR#	9	RI#
5	GND		

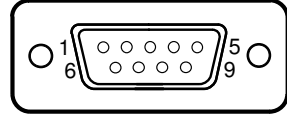

**COM1**

**COM2:** COM2 Connector, selectable as RS-232/422/485

Co-lay with the other COM port stacked over COM1.

PIN	ASSIGNMENT		
	RS-232	RS-422	RS-485
1	DCD#	TX-	RS-485-
2	RX	TX+	RS-485+
3	TX	RX+	X
4	DTR#	RX-	X
5	GND	GND	GND
6	DSR#	X	X
7	RTS#	X	X
8	CTS#	X	X
9	RI#	X	X

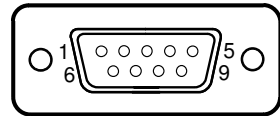

**COM2**

## 2-5. COM CONNECTOR

COM3, COM4: COM3 & COM4 Connectors, fixed as RS-232

PIN	ASSIGNMENT	PIN	ASSIGNMENT
1	DCD#	6	DSR#
2	RX	7	RTS#
3	TX	8	CTS#
4	DTR#	9	RI#
5	GND	10	NC

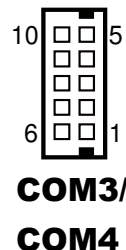

## 2-6. KEYBOARD & MOUSE PORT

KB\_MS1: PS/2 Keyboard & Mouse Port

Keyboard:

PIN	ASSIGNMENT	PIN	ASSIGNMENT
1	KBDATA	4	VCC5
2	NC	5	KBCLK
3	GND	6	NC

Mouse:

PIN	ASSIGNMENT	PIN	ASSIGNMENT
7	MSDATA	10	VCC5
8	NC	11	MSCLK
9	GND	12	NC

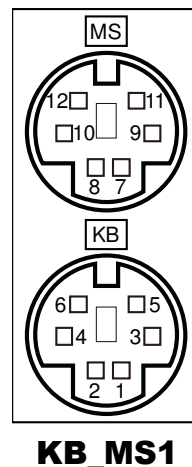

## 2-7. DVI PORT

**DVII:** Stacked DVI-D & DVI-I Ports

**DVI-D:** Supports only DVI signal.

PIN	ASSIGNMENT	PIN	ASSIGNMENT
1	DP_Data2-	13	NC
2	DP_Data2+	14	+5V Power
3	Ground	15	Ground
4	NC	16	HOT Plug Detect
5	NC	17	DP_Data0-
6	DP_Ctrl_Clock	18	DP_Data0+
7	DP_Ctrl_Data	19	Ground
8	CRT_VSYNC	20	NC
9	DP_Data1-	21	NC
10	DP_Data1+	22	Ground
11	Ground	23	DP_Clock+
12	NC	24	DP_Clock-

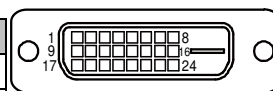

**DVI-D**

**DVI-I:** Supports DVI or VGA signal.

PIN	ASSIGNMENT	PIN	ASSIGNMENT
1	DP_Data2-	15	Ground
2	DP_Data2+	16	HOT Plug Detect
3	Ground	17	DP_Data0-
4	NC	18	DP_Data0+
5	NC	19	Ground
6	DP_Ctrl_Clock	20	NC
7	DP_Ctrl_Data	21	NC
8	CRT_VSYNC	22	Ground
9	DP_Data1-	23	DP_Clock+
10	DP_Data1+	24	DP_Clock-
11	Ground	C1	CRT_RED
12	NC	C2	CRT_GREE
13	NC	C3	CRT_BLUE
14	+5V Power	C4	CRT_HSYNC

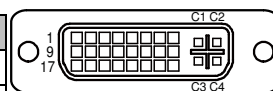

**DVI-I**

## 2-8. LAN & USB PORT

### LAN1\_USB1: LAN & Two USB3.0 Ports

#### LAN1 signal:

PIN	ASSIGNMENT	PIN	ASSIGNMENT
1	MDI_OP	5	MDI_2P
2	MDI_ON	6	MDI_2N
3	MDI_1P	7	MDI_3P
4	MDI_1N	8	MDI_3N

#### LAN LED Indicator:

##### Left Side LED

Red Color On	Giga LAN Speed Indicator
Off	No LAN switch/hub connected.

##### Right Side LED

Orange Color Blinking	LAN Message Active
Off	No LAN Message Active

#### USB3.0 signal:

PIN	ASSIGNMENT	PIN	ASSIGNMENT
A1	VCC5	B1	VCC5
A2	USBP0N	B2	USBP1N
A3	USBP0P	B3	USBP1P
A4	GND	B4	GND
A5	RX1_DN	B5	RX2_DN
A6	RX1_DP	B6	RX2_DP
A7	GND	B7	GND
A8	TX1_DN	B8	TX2_DN
A9	TX1_DP	B9	TX2_DP

Red Orange

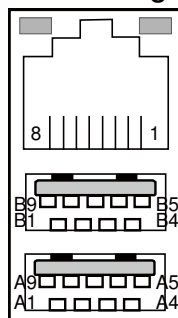

**LAN1\_USB1**

**LAN2\_USB2:** LAN & Two USB2.0 Ports

**LAN2 signal:**

PIN	ASSIGNMENT	PIN	ASSIGNMENT
1	MDI0_DP	5	MDI2_DP
2	MDI0_DN	6	MDI2_DN
3	MDI1_DP	7	MDI3_DP
4	MDI1_DN	8	MDI3_DN

**LAN LED Indicator:**

Left Side LED

Red Color On	Giga LAN Speed Indicator
Off	No LAN switch/hub connected.

Right Side LED

Orange Color Blinking	LAN Message Active
Off	No LAN Message Active

**USB2.0 signal:**

PIN	ASSIGNMENT	PIN	ASSIGNMENT
A1	VCC5	B1	VCC5
A2	USBP2N	B2	USBP3N
A3	USBP2P	B3	USBP3P
A4	GND	B4	GND

Red Orange

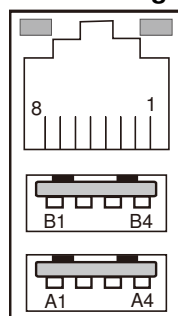

**LAN2\_USB2**

## 2-9. AUDIO JACK

### AUDIO1: Line-In, Line-Out & Microphone

The connector can also support only Microphone.

#### Line-In:

PIN	ASSIGNMENT
32	HD_LINE-IN-L
33	GND
34	GND
35	HD_LINE-IN-R

#### Line-Out:

PIN	ASSIGNMENT
22	LINE-OUT-L
23	GND
24	GND
25	LINE-OUT-R

#### Mic-In:



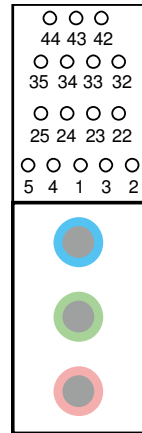



PIN	ASSIGNMENT
1	GND
2	HD_MIC1-L_L
3	GND
4	GND
5	HD_MIC1-R_L



**AUDIO1**

## 2-10. COM PORT RI & VOLTAGE SELECTION



**JP\_COM1 & JP\_COM2:** COM1 & COM2 Ports RI & Voltage Selection

SELECTION	JUMPTER SETTING	JUMPER ILLUSTRATION	
RI	1-2	 <p><b>JP_COM1</b></p>	 <p><b>JP_COM2</b></p>
12V	3-4	 <p><b>JP_COM1</b></p>	 <p><b>JP_COM2</b></p>
5V	5-6	 <p><b>JP_COM1</b></p>	 <p><b>JP_COM2</b></p>

**Note:** Manufacturing default is RI.

## 2-11. COM2 RS-232/422/485 SELECTION

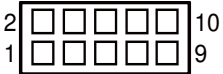
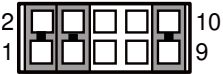

**JP8:** RS-232/422/485 (COM2) Selection Connector, used to set COM2 function.

SELECTION	JUMPER SETTINGS	JUMPER ILLUSTRATION
RS-232	All Open	 <p style="text-align: center;"><b>JP8</b></p>
RS-422	1-2, 3-4, 9-10	 <p style="text-align: center;"><b>JP8</b></p>
RS-485	1-2, 5-6, 7-8	 <p style="text-align: center;"><b>JP8</b></p>

**Note:** Manufacturing default is RS-232.

## 2-12. COM2 AUTO-DETECT SELECTION

**JP7:** COM2 Auto-detect Selection

SELECTION	JUMPER SETTINGS	JUMPER ILLUSTRATION
Normal	1-2	 <p style="text-align: center;"><b>JP7</b></p>
Auto Gating	2-3	 <p style="text-align: center;"><b>JP7</b></p>

**Note:** Manufacturing default is Normal.



## 2-13. FRONT PANEL CONNECTOR & SELECTION

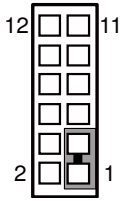
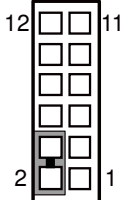
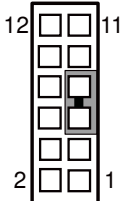

**FP1:** Front Panel Connector

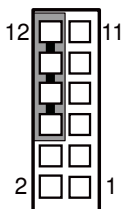
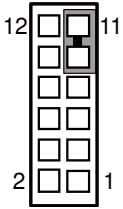
SELECTION	PIN & ASSIGNMENT	JUMPER SETTINGS	JUMPER ILLUSTRATION
HDD LED	1. HDD_LED+	1-3	 <p><b>FP1</b></p>
	3. HDD_LED-		
Power LED	2. PWR_LED+	2-4	 <p><b>FP1</b></p>
	4. PWR_LED-		
Reset Button	5. GND	5-7	 <p><b>FP1</b></p>
	7. RST_BTN		

SELECTION	PIN & ASSIGNMENT	JUMPER SETTINGS	JUMPER ILLUSTRATION
External Speaker	6. SPK_VCC	6-8-10-12	 <p><b>FP1</b></p>
	8. Speaker signal		
	10. Speaker signal		
	12. Speaker signal		
ATX Power Button	9. GND	9-11	 <p><b>FP1</b></p>
	11. PWRBTNSW		

## 2-14. INTEL® ME SELECTION



### JP3: Intel® ME Selection

SELECTION	JUMPER SETTINGS	JUMPER ILLUSTRATION
Normal	Open	 <p><b>JP3</b></p>
ME Disabled	Close	 <p><b>JP3</b></p>

**Note:** Manufacturing Default is Normal.

## 2-15. CLEAR CMOS DATA SELECTION

### JP4: Clear CMOS Data Selection



SELECTION	JUMPER SETTINGS	JUMPER ILLUSTRATION
Normal	Open	
Clear CMOS*	Close	

**Note:** Manufacturing Default is Normal.

\*To clear CMOS data, user must power-off the computer and set the jumper to “Clear CMOS” as illustrated above. After five to six seconds, set the jumper back to “Normal” and power-on the computer.

## 2-16. BIOS RECOVERY MODE SELECTION

### JP1: BIOS Recovery Mode Selection

SELECTION	JUMPER SETTINGS	JUMPER ILLUSTRATION
Recovery	Open	
Normal	Close	

**Note:** Manufacturing Default is Normal.

## 2-17. FAN CONNECTOR

**CPU\_FAN1:** CPU Fan Connector

**SYS\_FAN1:** System Fan Connector

PIN	ASSIGNMENT
1	GND
2	VCC12
3	TAC
4	CTL

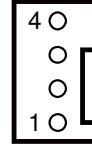

**CPU\_FAN1/  
SYS\_FAN1**

**SYS\_FAN2:** System Fan Connector

PIN	ASSIGNMENT
1	GND
2	VCC12
3	NC

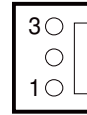

**SYS\_FAN2**

## 2-18. SATA CONNECTOR

**SATA1, SATA2, SATA3:** Three Serial ATA Connectors

PIN	ASSIGNMENT	PIN	ASSIGNMENT
1	GND	5	RXNC
2	TXPC	6	RXPC
3	TXNC	7	GND
4	GND		



**SATA1/  
SATA2/  
SATA3**

## 2-19. USB CONNECTOR

**USB3, USB4:** USB Connectors

PIN	ASSIGNMENT	PIN	ASSIGNMENT
1	VCC5	6	USBP
2	VCC5	7	GND
3	USBN	8	GND
4	USBN	9	NC
5	USBP	10	GND

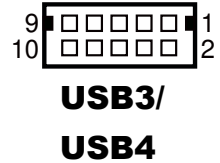

## 2-20. DISPLAY PORT CONNECTOR

**DP1:** Display Port Connector

PIN	ASSIGNMENT	PIN	ASSIGNMENT
1	DATA0+	11	GND
2	GND	12	DATA3-
3	DATA0-	13	AUX_ENJ
4	DATA1+	14	GND
5	GND	15	AUX+
6	DATA1-	16	HPD
7	DATA2+	17	AUX-
8	GND	18	VCC3_3
9	DATA2-	19	VCC5
10	DATA3+	20	VCC3_3

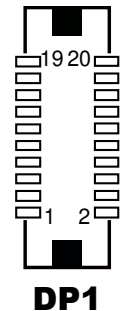

## 2-21. ATX POWER CONNECTOR

**ATX\_PWR1:** ATX Power Connector

PIN	ASSIGNMENT	PIN	ASSIGNMENT
1	+3.3V	13	+3.3V
2	+3.3V	14	-12V
3	GND	15	GND
4	+5V	16	PSON
5	GND	17	GND
6	+5V	18	GND
7	GND	19	GND
8	POK	20	-5V
9	5VSB	21	+5V
10	+12V	22	+5V
11	+12V	23	+5V
12	+3.3V	24	GND

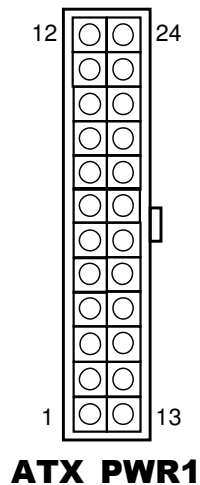

**ATX\_PWR2:** ATX Power Connector

PIN	ASSIGNMENT	PIN	ASSIGNMENT
1	GND	3	+12V
2	GND	4	+12V

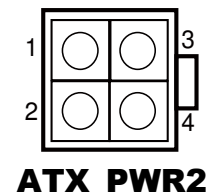

# ***SOFTWARE UTILITIES***

CHAPTER
<b>3</b>

This chapter comprises the detailed information of VGA driver, LAN driver, and Sound driver.

Sections included:

- Introduction.
- Intel® Chipset Software Installation Utility
- Intel® Rapid Storage Technology Utility
- Intel® USB3.0 eXtensible Host Controller Utility
- Intel® Management Engine Components Utility
- VGA Driver Utility
- LAN Driver Utility
- Sound Driver Utility

### 3-1. INTRODUCTION

Enclosed with our BM-0942 package are our driver utilities, which come in a format of CD ROM. Refer to the following table for driver locations: and go to the corresponding folder for the chipset Intel® H81 or Intel® Q87:

For Intel® H81:

FILENAME (Assume that CD ROM drive is D:)	PURPOSE
<ul style="list-style-type: none"> <li>▪ D:\H81\Driver\Plaform\Win7,Win8(32-bit)\Main Chip</li> <li>▪ D:\H81\Driver\Plaform\Win7,Win8(64-bit)\Main Chip</li> </ul>	Intel® chipset device software installation utility
<ul style="list-style-type: none"> <li>▪ D:\H81\Driver\Plaform\Win7,Win8(32-bit)\USB3.0</li> <li>▪ D:\H81\Driver\Plaform\Win7,Win8(64-bit)\USB3.0</li> </ul>	Intel® USB3.0 eXtensible host controller
<ul style="list-style-type: none"> <li>▪ D:\H81\Driver\Plaform\Win7,Win8(32-bit)\ME</li> <li>▪ D:\H81\Driver\Plaform\Win7,Win8(64-bit)\ME</li> </ul>	Intel® Management Engine Interface
<ul style="list-style-type: none"> <li>▪ D:\H81\Driver\Plaform\Win7,Win8(32-bit)\COM</li> <li>▪ D:\H81\Driver\Plaform\Win7,Win8(64-bit)\COM</li> </ul>	Patch files for COM ports
<ul style="list-style-type: none"> <li>▪ D:\H81\Driver\Plaform\Win7,Win8(32-bit)\VGA</li> <li>▪ D:\H81\Driver\Plaform\Win7,Win8(64-bit)\VGA</li> </ul>	Intel® HD Graphics Family for VGA driver installation
<ul style="list-style-type: none"> <li>▪ D:\H81\Driver\Plaform\Win7,Win8(32-bit)\LAN</li> <li>▪ D:\H81\Driver\Plaform\Win7,Win8(64-bit)\LAN</li> </ul>	Intel® I217-LM/V & I210-AT for LAN driver installation
<ul style="list-style-type: none"> <li>▪ D:\H81\Driver\Plaform\Win7,Win8(32-bit)\Sound</li> <li>▪ D:\H81\Driver\Plaform\Win7,Win8(64-bit)\Sound</li> </ul>	Realtek ALC888S for sound driver installation
D:\H81\Driver\Flash BIOS	BIOS update utility

**Note:** Be sure to install the Utility right after the OS fully installed.



For Intel® Q87:

FILENAME (Assume that CD ROM drive is D:)	PURPOSE
<ul style="list-style-type: none"> <li>▪ D:\Q87\Driver\Plaform\Win7,Win8(32-bit)\Main Chip</li> <li>▪ D:\Q87\Driver\Plaform\Win7,Win8(64-bit)\Main Chip</li> </ul>	Intel® chipset device software installation utility
<ul style="list-style-type: none"> <li>▪ D:\Q87\Driver\Plaform\Win7,Win8(32-bit)\RAID</li> <li>▪ D:\Q87\Driver\Plaform\Win7,Win8(64-bit)\RAID</li> </ul>	Intel® Rapid Storage Technology (formerly Matrix RAID) driver installation
<ul style="list-style-type: none"> <li>▪ D:\Q87\Driver\Plaform\Win7,Win8(32-bit)\USB3.0</li> <li>▪ D:\Q87\Driver\Plaform\Win7,Win8(64-bit)\USB3.0</li> </ul>	Intel® USB3.0 eXtensible host controller
<ul style="list-style-type: none"> <li>▪ D:\Q87\Driver\Plaform\Win7,Win8(32-bit)\ME</li> <li>▪ D:\Q87\Driver\Plaform\Win7,Win8(64-bit)\ME</li> </ul>	Intel® Management Engine Interface
<ul style="list-style-type: none"> <li>▪ D:\Q87\Driver\Plaform\Win7,Win8(32-bit)\COM</li> <li>▪ D:\Q87\Driver\Plaform\Win7,Win8(64-bit)\COM</li> </ul>	Patch files for COM ports
<ul style="list-style-type: none"> <li>▪ D:\Q87\Driver\Plaform\Win7,Win8(32-bit)\VGA</li> <li>▪ D:\Q87\Driver\Plaform\Win7,Win8(64-bit)\VGA</li> </ul>	Intel® HD Graphics Family for VGA driver installation
<ul style="list-style-type: none"> <li>▪ D:\Q87\Driver\Plaform\Win7,Win8(32-bit)\LAN</li> <li>▪ D:\Q87\Driver\Plaform\Win7,Win8(64-bit)\LAN</li> </ul>	Intel® I217-LM/V & I210-AT for LAN driver installation
<ul style="list-style-type: none"> <li>▪ D:\Q87\Driver\Plaform\Win7,Win8(32-bit)\Sound</li> <li>▪ D:\Q87\Driver\Plaform\Win7,Win8(64-bit)\Sound</li> </ul>	Realtek ALC888S for sound driver installation
D:\Q87\Driver\Flash BIOS	BIOS update utility

**Note:** Be sure to install the Utility right after the OS fully installed.

## **3-2. INTEL® CHIPSET SOFTWARE INSTALLATION UTILITY**

### **3-2-1. Introduction**

The Intel® Chipset Device Software installs Windows INF files to the target system. These files outline to the operating system how to configure the Intel® chipset components in order to ensure that the following features function properly:

- Core PCI and ISAPNP Services
- PCIe Support
- IDE/ATA33/ATA66/ATA100 Storage Support
- SATA Storage Support
- USB Support
- Identification of Intel® Chipset Components in the Device Manager

### **3-2-2. Installation of Utility for Windows 7/8**

The Utility Pack is to be installed only for Windows 7/8 series, and it should be installed right after the OS installation. Please follow the steps below:

1. Insert the driver disk into a CD ROM device.
2. Under Windows system, go to the directory where the Utility driver is located.
3. Run the application with administrative privileges.

## **3-3. INTEL® RAPID STORAGE TECHNOLOGY UTILITY**

### **3-3-1. Introduction**

The Intel® RST driver utility supports RAID 0, 1, 5 and fully compatible with Windows 7/8 series, and it should be installed after the operating system is installed completely. Perform F6 and RAID BIOS configurations prior to installation of this driver for proper operation.

**Note:** This utility is applicable to Intel® Q87 only.

### **3-3-2. Installation of RST Driver for Windows 7/8**

To install the utility, simply follow the following steps:

1. Insert the driver disk into a CD ROM device.
2. Under Windows system, go to the directory where the RST driver is located.
3. Run the application with administrative privileges.

## **3-4. INTEL® USB3.0 EXTENSIBLE HOST CONTROLLER UTILITY**

### **3-4-1. Introduction**

Intel® USB 3.0 eXtensible Host Controller Driver supports the following Intel® Chipsets/Processors:

- 4<sup>th</sup> Generation Intel® Core™ Processor Family
- Intel® 8 Series/C220 Series Chipset Family
- 4<sup>th</sup> Generation U-Series Platform I/O

### **3-4-2. Installation Instructions for Windows 7/8**

To install the utility, simply follow the following steps:

1. Insert the driver disk into a CD ROM device.
2. Under Windows system, go to the directory where the driver is located.
3. Run the application with administrative privileges.

## **3-5. INTEL® MANAGEMENT ENGINE COMPONENTS UTILITY**

### **3-5-1. Introduction**

The Intel® ME software components that need to be installed depend on the system's specific hardware and firmware features. The installer, compatible with Windows 7/8 series, detects the system's capabilities and installs the relevant drivers and applications.

### **3-5-2. Installation Instructions for Windows 7/8**

To install the utility, simply follow the following steps:

1. Insert the driver disk into a CD ROM device.
2. Under Windows system, go to the directory where the driver is located.
3. Run the application with administrative privileges.

## 3-6. VGA DRIVER UTILITY

### 3-6-1. Introduction

The VGA interface embedded with our BM-0942 can support a wide range of display. You can display DVI simultaneously with the same mode.

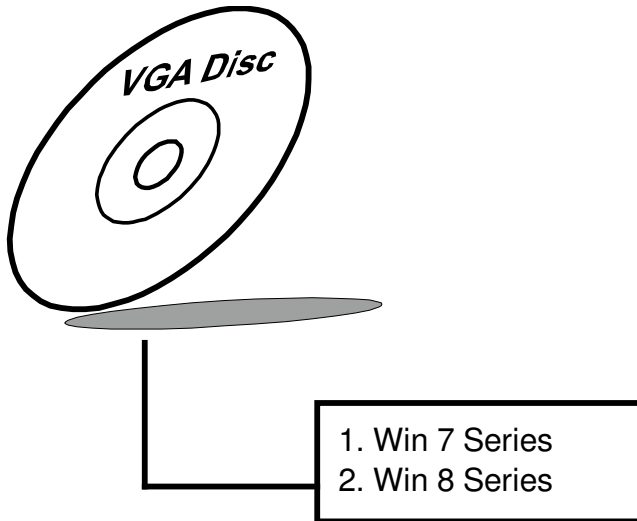

### 3-6-2. Installation of VGA Driver

To install the VGA Driver, simply follow the following steps:

1. Insert the driver disk into a CD ROM device.
2. Under Windows system, go to the directory where the VGA driver is located.
3. Run the application with administrative privileges..

## 3-7. LAN DRIVER UTILITY

### 3-7-1. Introduction

BM-0942 is enhanced with LAN function that can support various network adapters. Installation programs for LAN drivers are listed as follows:

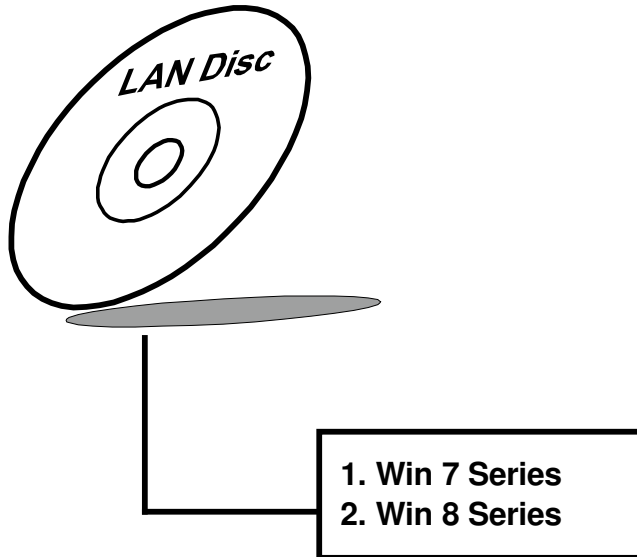

For more details on Installation procedure, please refer to Readme.txt file found on LAN Driver Utility.

## 3-8. SOUND DRIVER UTILITY

### 3-8-1. Introduction

The Realtek sound function enhanced in this system is fully compatible with Windows 7/8. Below, you will find the content of the Sound driver:

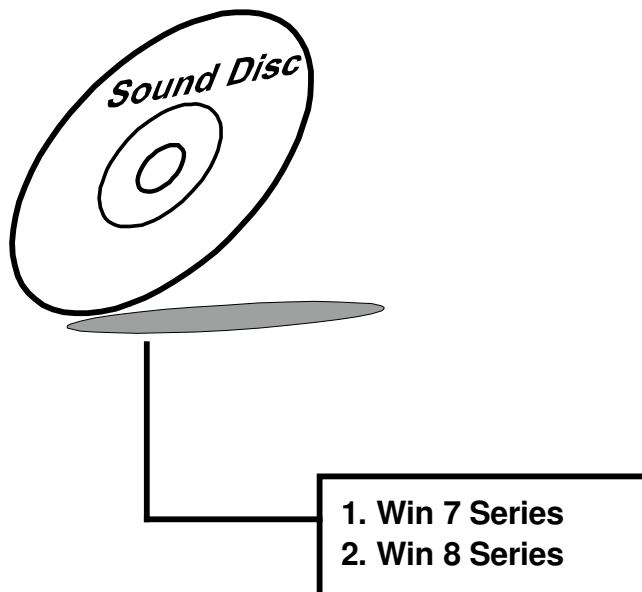

### 3-8-2. Installation of Sound Driver

1. Insert the driver disk into a CD ROM device.
2. Under Windows system, go to the directory where the Sound driver is located.
3. Run the application with administrative privileges..
4. Follow the instructions on the screen to complete the installation.
5. Once the installation is completed, shut down the system and restart in order for the changes to take effect.



# ***BIOS SETUP***

This chapter shows how to set up the BIOS.

Sections included:

- Introduction
- Entering Setup
- Main
- Advanced
- Chipset
- Boot
- Security
- Save & Exit

## 4-1. INTRODUCTION

The board BM-0942 (with Intel® H81/Q87) uses an AMI Aptio BIOS that is stored in the Serial Peripheral Interface Flash Memory (SPI Flash) and can be updated. The SPI Flash contains the BIOS Setup program, Power-on Self-Test (POST), the PCI auto-configuration utility, LAN EEPROM information, and Plug and Play support.

Aptio is AMI's BIOS firmware based on the UEFI (Unified Extensible Firmware Interface) Specifications and the Intel Platform Innovation Framework for EFI. The UEFI specification defines an interface between an operating system and platform firmware. The interface consists of data tables that contain platform-related information, boot service calls, and runtime service calls that are available to the operating system and its loader. These provide standard environment for booting an operating system and running pre-boot applications. Following illustration shows Extensible Firmware Interface's position in the software stack.

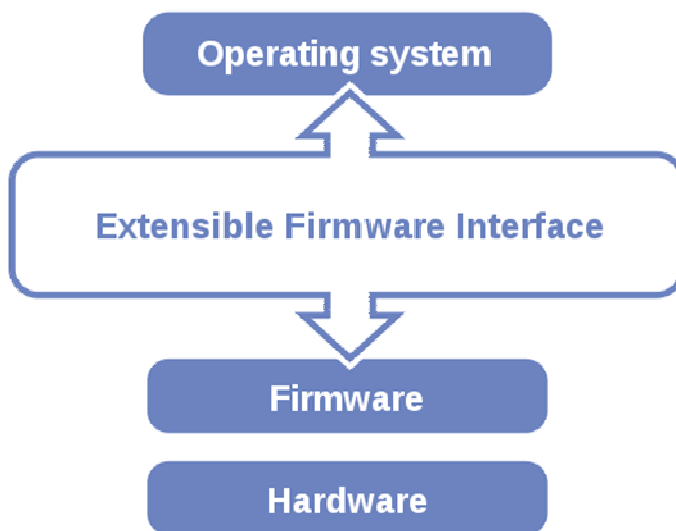

EFI BIOS provides an user interface allow users the ability to modify hardware configuration, e.g. change system date and time, enable or disable a system component, decide bootable device priorities, setup personal password, etc., which is convenient for modifications and customization of the computer system and allows technicians another method for finding solutions if hardware has any problems.

The BIOS Setup program can be used to view and change the BIOS settings for the computer. The BIOS Setup program is accessed by pressing the <Del> or <ESC> key after the POST memory test begins and before the operating system boot begins. The settings are shown below.

## **4-2. ENTERING SETUP**

When the system is powered on, the BIOS will enter the Power-On Self Test (POST) routines and the following message will appear on the lower screen:



**POST screen**

As long as this message is present on the screen you may press the <Del> key (the one that shares the decimal point at the bottom of the number keypad) to access the Setup program. In a moment, the main menu of the Aptio Setup Utility will appear on the screen:



**BIOS setup program initial screen**

You may move the cursor by up/down keys to highlight the individual menu items. As you highlight each item, a brief description of the highlighted selection will appear at the bottom of the screen.

## 4-3. MAIN



Main screen

BIOS Setting	Options	Description/Purpose
BIOS Vendor	No changeable options	Displays the BIOS vendor.
Core Version	No changeable options	Displays the current BIOS core version.
Compliancy	No changeable options	Displays the current UEFI version.
Project Version	No changeable options	Displays the version of the BIOS currently installed on the platform.
Build Date and Time	No changeable options	Displays the date of current BIOS version.
System Date	Month, day, year	Specifies the current date.
System Time	Hour, minute, second	Specifies the current time.
Access Level	No changeable options	Displays the current user level.

## 4-4. ADVANCED

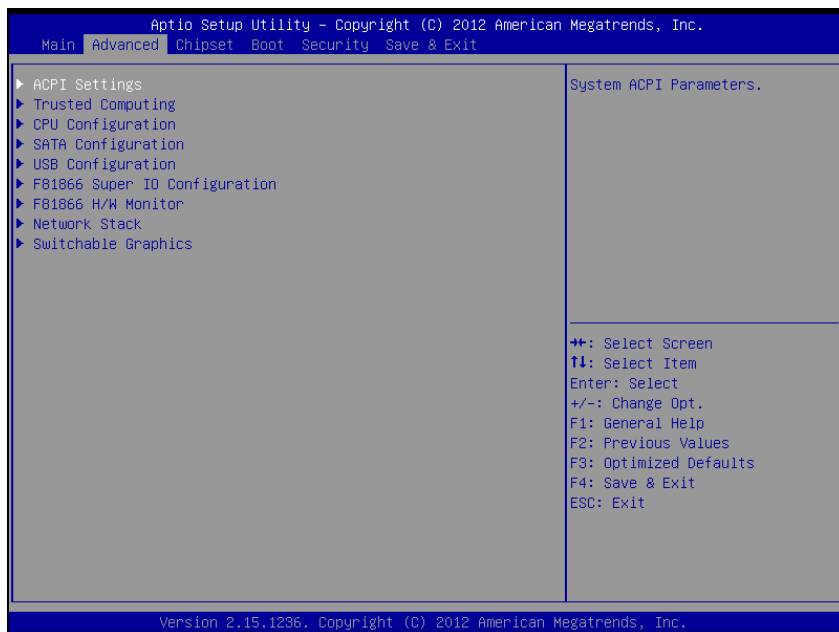

Advanced screen

BIOS Setting	Options	Description/Purpose
ACPI Settings	Sub-Menu	System ACPI Parameters.
Trusted Computing	Sub-Menu	Trusted Computing Parameters.
CPU Configuration	Sub-Menu	CPU Configuration. Parameters.
SATA Configuration	Sub-Menu	SATA Configuration Parameters.
USB Configuration	Sub-Menu	USB Configuration Parameters.
F81866 Super IO Configuration	Sub-Menu	System Super IO Chip Parameters.
F81866 HW Monitor	Sub-Menu	Monitor hardware status
Network stack	Sub-Menu	UEFI network setting
Switchable Graphics	No changeable options	Switchable Graphics selections

## 4-4-1. ACPI Settings

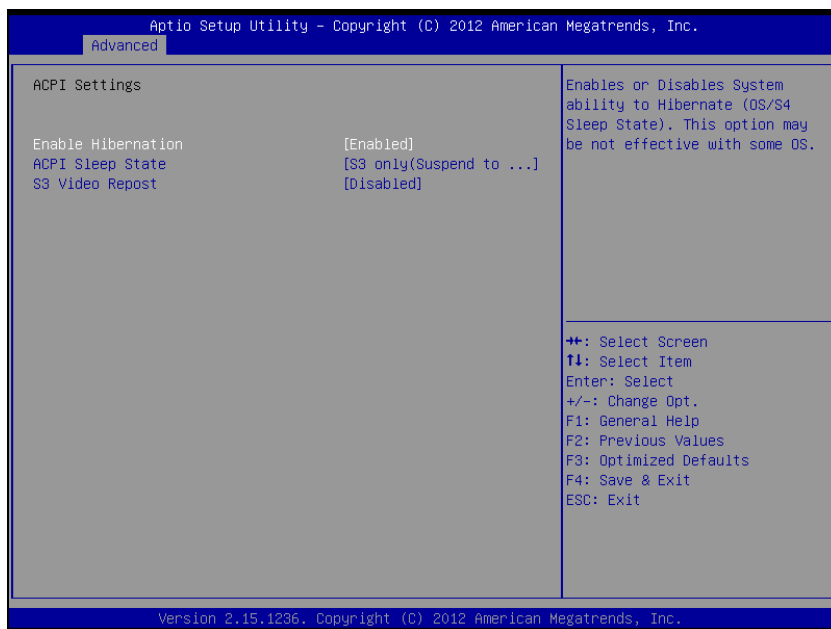

ACPI settings screen

BIOS Setting	Options	Description/Purpose
Enable Hibernation	- Disabled - Enabled	Enables or disables system ability to hibernate (OS/S4 Sleep State). This may be not effective with some OS.
ACPI Sleep State	- Suspend Disabled - S1 (CPU Stop Clock) - S3 (Suspend to RAM) - Both S1 and S3 available for OS to choose from	Specifies the ACPI sleep state. <ul style="list-style-type: none"> <li>▪ <b>Suspend Disabled</b> disables ACPI sleep feature.</li> <li>▪ <b>S1</b> mode allows the CPU enter Stop Clock mode to stop executing instructions.</li> <li>▪ <b>S3</b> allows the platform to enter Suspend to RAM mode.</li> <li>▪ <b>Both S1 and S3</b> available for OS to choose from allows the OS to choose the sleep state type.</li> </ul>



<b>BIOS Setting</b>	<b>Options</b>	<b>Description/Purpose</b>
S3 Video Repost	- Disabled - Enabled	Enable or Disable S3 video Repost

## 4-4-2. Trusted Computing

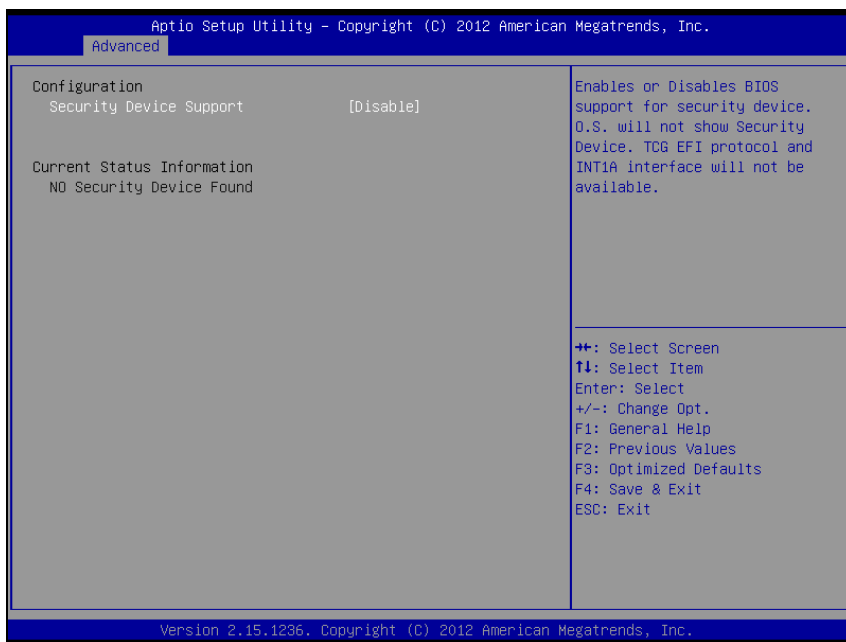

Trusted Computing screen

BIOS Setting	Options	Description/Purpose
Security Device Support	- Disabled - Enabled	Enables or Disables BIOS support for security device
Current Status Information	No changeable options	Display current security device information

## 4-4-3. CPU Configuration

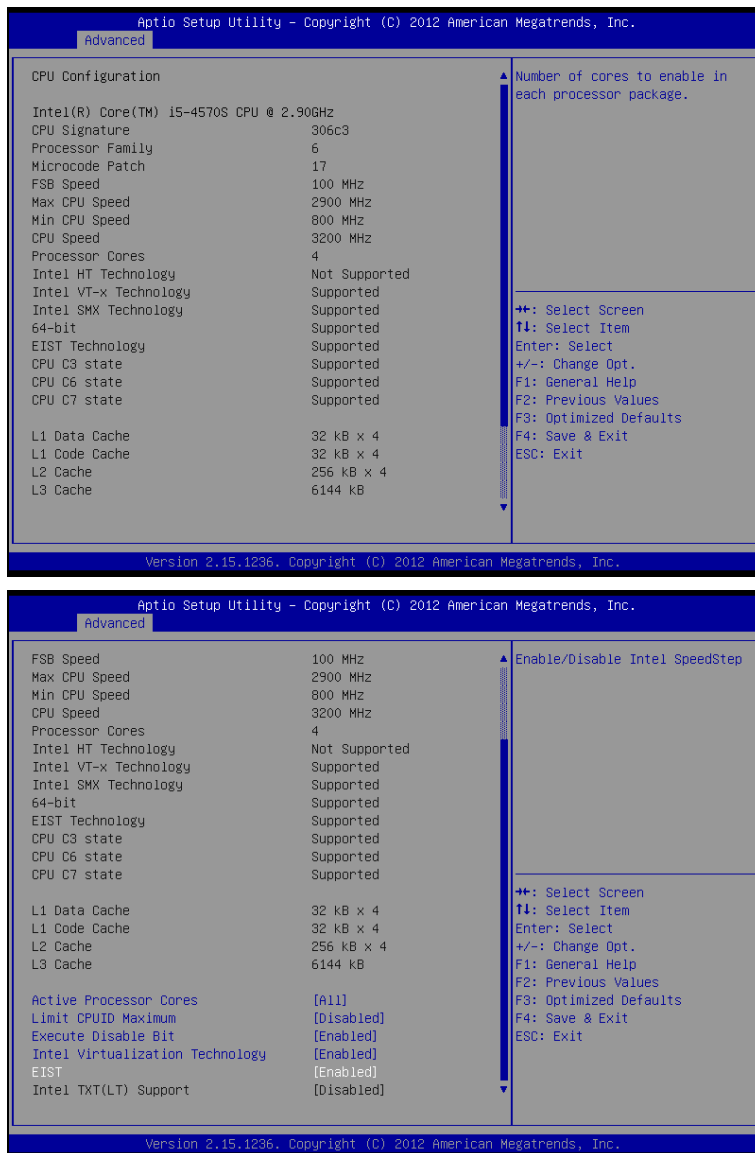

CPU configuration screen

BIOS Setting	Options	Description/Purpose
CPU Signature	No changeable options	Reports the CPU Signature
Processor Family	No changeable options	Reports the CPU Family
Microcode Patch	No changeable options	Reports the CPU Microcode Patch Version.
FSB Speed	No changeable options	Display FSB Speed
Max CPU Speed	No changeable options	Reports the Max CPU Speed.
Min CPU Speed	No changeable options	Reports the Min CPU Speed
CPU Speed	No changeable options	Display CPU Speed
Processor Cores	No changeable options	Displays number of physical cores in processor.
Intel HT Technology	No changeable options	Reports if Intel Hyper-Threading Technology is supported by processor
Intel VT-x Technology	No changeable options	Reports if Intel VT-x Technology is supported by processor.
Intel SMX Technology	No changeable options	Reports if Intel SMX Technology is supported by processor.
64-bit	No changeable options	Report if 64 bit support by processor
EIST	No changeable options	Report if EIST support by processor
CPU C3/C6/C7 state	No changeable options	Report if C3/C6/C7 support by processor
L1 Data Cache	No changeable options	Displays size of L1 Data Cache
L1 Code Cache	No changeable options	Displays size of L1 Code Cache
L2 Cache	No changeable options	Displays size of L2 Cache.
L3 Cache	No changeable options	Displays size of L3 Cache.
Active Processor Cores	- All - 1 - 2 - 3	Indicates the number of cores to enable in processor.
Limit CPUID Maximum	- Disabled - Enabled	Enables for legacy operating systems to boot processors with extended CPUID functions.

<b>BIOS Setting</b>	<b>Options</b>	<b>Description/Purpose</b>
Execute Disable Bit	- Disabled - Enabled	XD can prevent certain classes of malicious buffer overflow attacks when combined with a supporting OS (Windows Server 2003 SP1, Windows XP Sp2, SuSE Linux 9.2, Redhat Enterprise 3 Update 3.)
Intel Virtualization Technology	-Disabled -Enabled	When enabled, a VMM can utilize the additional hardware capabilities provided by Vander pool Technology.
EIST	-Disabled -Enabled	Enable or Disable EIST

## 4-4-4. SATA Configuration

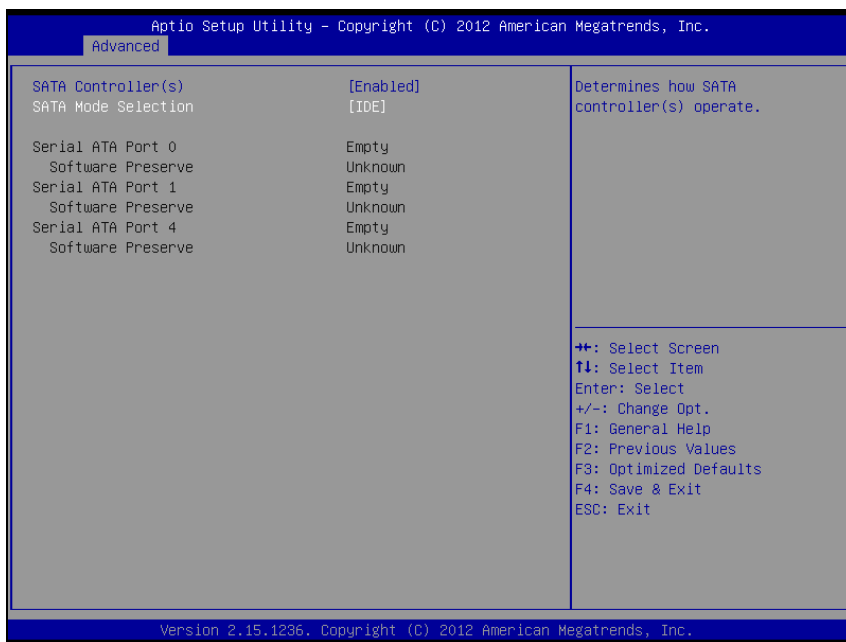

SATA configuration screen

BIOS Setting	Options	Description/Purpose
SATA Controller(s)	- Disabled - Enabled	Enable or disable SATA Device.
SATA Mode Selection	- IDE - AHCI - RAID	Configures SATA as IDE, AHCI or RAID(Q87 only) mode.
SATA 0/1/4	[drive]	Displays the drive installed on this SATA port. Shows [Empty] if no drive is installed.

When you select SATA Mode as [AHCI] or [RAID], it shows more items as below.

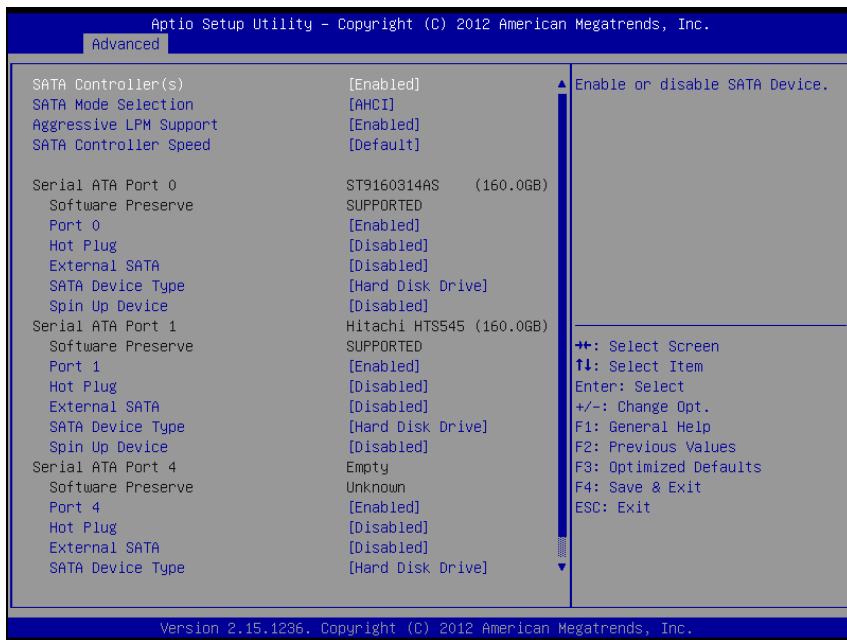

AHCI/RAID screen

BIOS Setting	Options	Description/Purpose
SATA Controller(s)	- Disabled - Enabled	Enable SATA Controller
Aggressive LPM Support	- Disabled - Enabled	Enable PCH to aggressively enter link power state.
SATA Controller Speed	- Gen1 - Gen2 - Gen3	Indicates the maximum speed the SATA controller can support.
Port 0/1/4	- Disabled - Enabled	Enables or disable SATA port.
Hot Plug	- Disabled - Enabled	Designates this port as Hot Pluggable.

<b>BIOS Setting</b>	<b>Options</b>	<b>Description/Purpose</b>
External SATA	- Disabled - Enabled	External SATA Support.
SATA Device Type	- Hard Disk Driver - Solid State Drive	Identify the SATA port is connected to Solid State Drive or Hard Disk Drive.
Spin Up Device	- Disabled - Enabled	On an edge detect from 0 to 1, the PCH starts a COMRESET initialization sequence to the device.



## 4-4-5. USB Configuration

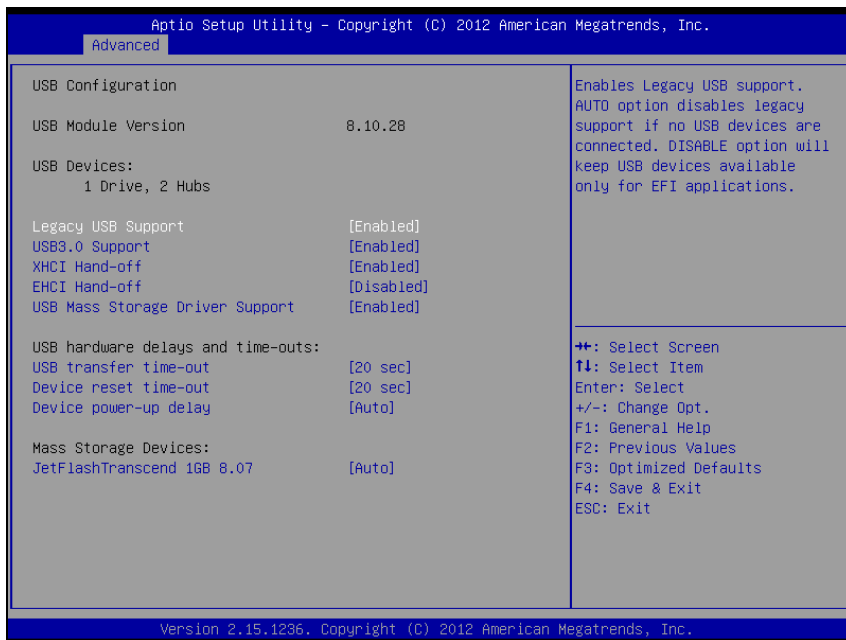

USB configuration screen

BIOS Setting	Options	Description/Purpose
USB Devices	No changeable options	Displays number of available USB devices.
Legacy USB Support	- Enabled - Disabled - Auto	Enables support for legacy USB.
USB 3.0 Support	- Enabled - Disabled	Enable/Disable USB3.0 (XHCI) controller support.
XHCI Hand-off	- Enabled - Disabled	This is a workaround for OSeS without XHCI hand-off support.
EHCI Hand-off	- Disabled - Enabled	This is a workaround for OSeS w/o EHCI hand-off support.

<b>BIOS Setting</b>	<b>Options</b>	<b>Description/Purpose</b>
USB transfer time-out	1/5/10/20 sec	The time-out value for Control, Bulk, and Interrupt transfers.
Device reset time-out	10/20/30/40 sec	USB mass storage device Start Unit command time-out.
Device power-up delay	- Auto - Manual	Maximum time the device will take before it properly reports itself to the Host Controller. 'Auto' uses default value: for a Root port it is 100 ms, for a Hub port the delay is taken from Hub descriptor.

## 4-4-6. F81866 Super IO Configuration

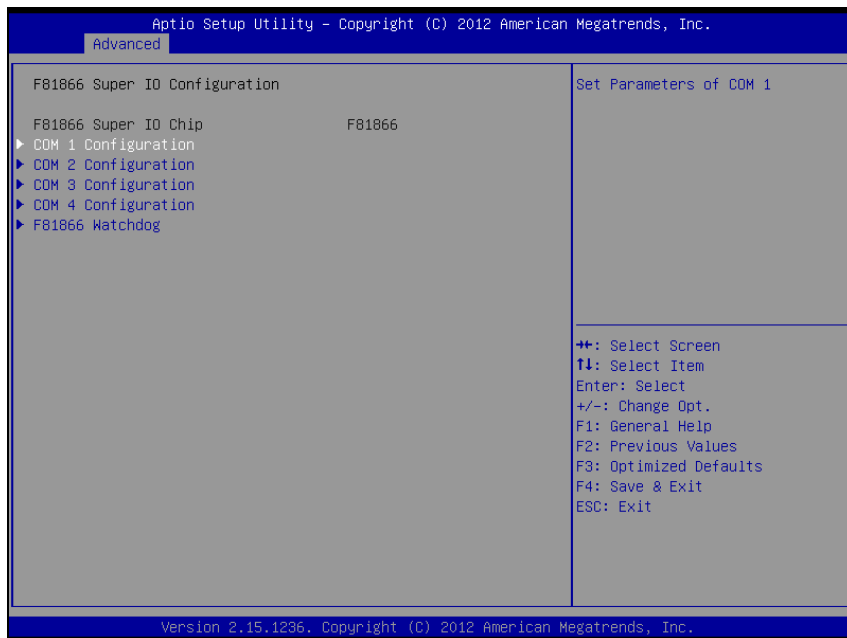

F81866 Super IO Configuration screen

BIOS Setting	Options	Description/Purpose
F81866 Super IO Chip	No changeable options	Displays the super IO chip model and its manufacturer.
COM 1/2/3/4	Sub-menu	Set Parameters for COM 1/2/3/4
F81866 Watchdog	Sub-menu	Set watchdog time

4-4-6-1. COM 1/2/3/4 Configuration

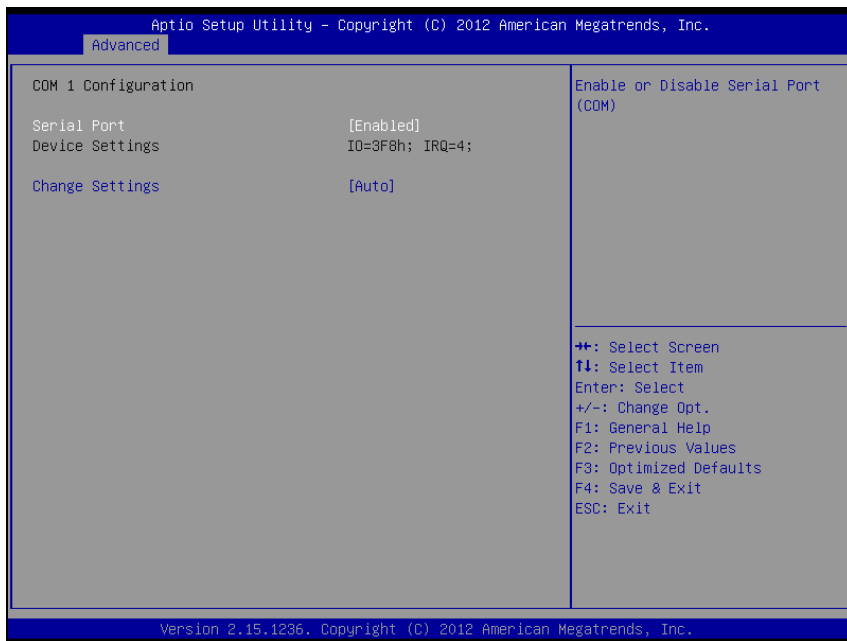

COM 1/2/3/4 Configuration screen

BIOS Setting	Options	Description/Purpose
Serial Port	- Disabled - Enabled	Enable/Disable COM 1.
Device Settings	No changeable options	Reports the current COM 1 setting.
Change Settings	- Auto - IO=3F8h; IRQ=4 - IO=3F8h; IRQ=3,4,5,6,7,10,11,12 - IO=2F8h; IRQ=3,4,5,6,7,10,11,12 - IO=3E8h; IRQ=3,4,5,6,7,10,11,12 - IO=2E8h; IRQ=3,4,5,6,7,10,11,12	Specifies the base I/O address and interrupt request for the serial port 0 if enabled.

## 4-4-6-2. F81866 Watchdog

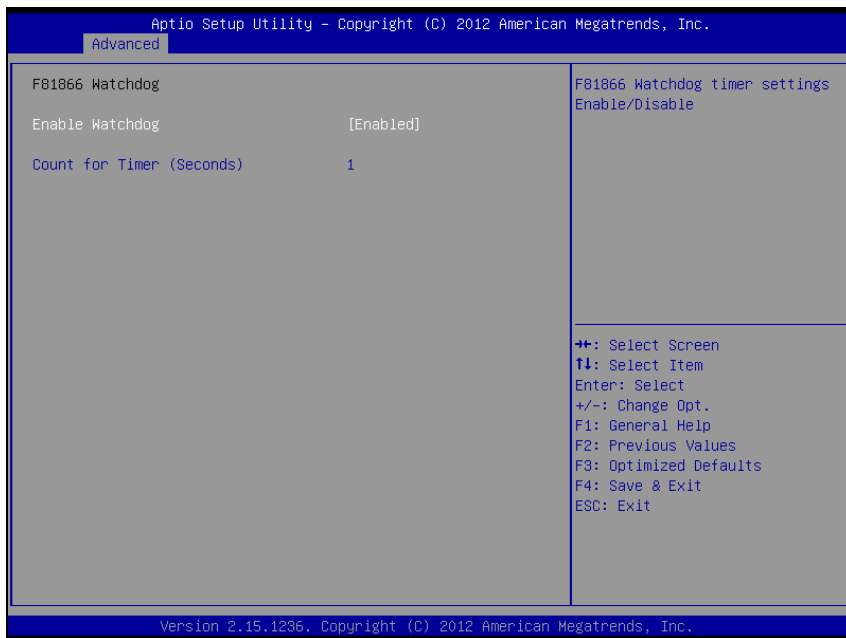

F81866 Watchdog screen

BIOS Setting	Options	Description/Purpose
Enable watchdog	- Disabled - Enabled	Enable/Disable COM 1.
Count for Timer (Seconds)	Timer value	The number of second count for timer (1-255 seconds)

## 4-4-7. F81866 Hardware Monitor

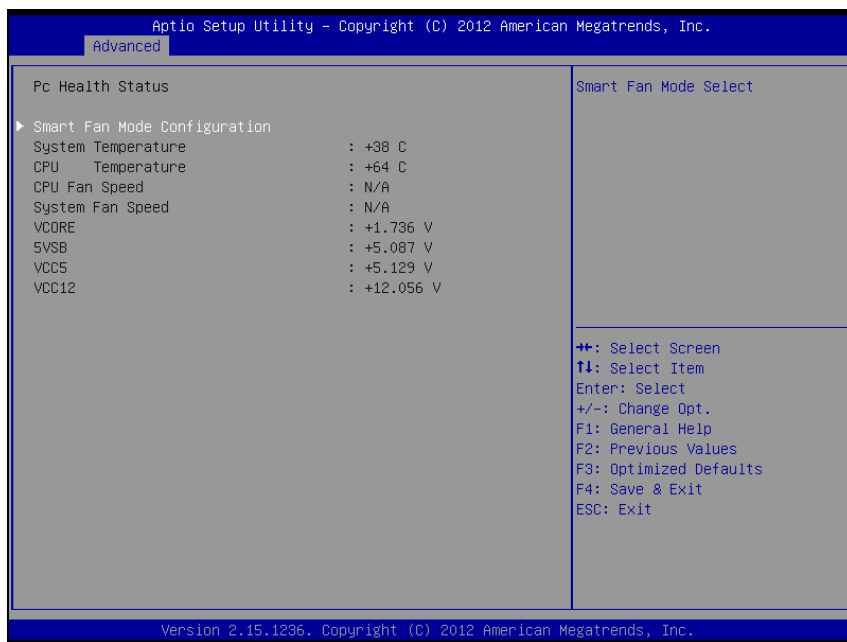

F81866 Hardware Monitor screen

BIOS Setting	Options	Description/Purpose
Smart Fan Mode Configuration	Sub-menu	Smart Fan Mode select.
System Temperature	No changeable options	Displays temperature in the remote thermal sensor zone.
CPU Temperature	No changeable options	Displays processor's temperature.
CPU Fan Speed	No changeable options	Displays fan speed of the CPU fan.
System Fan Speed	No changeable options	Displays fan speed of the system fan
VCORE	No changeable options	Displays voltage level of the +Vcore in supply.

<b>BIOS Setting</b>	<b>Options</b>	<b>Description/Purpose</b>
5VSB	No changeable options	Displays voltage level of the +5V in supply.
VCC5	No changeable options	Displays voltage level of the +5V in supply.
VCC12	No changeable options	Displays voltage level of the +12V in supply.

## 4-4-7-1. Smart Fan Mode Configuration

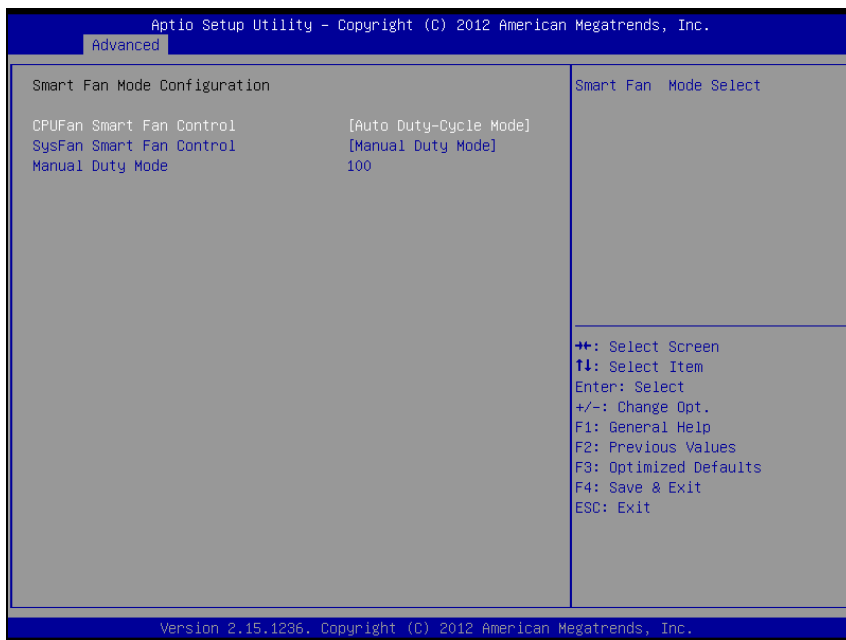

Smart Fan Mode Configuration screen

BIOS Setting	Options	Description/Purpose
CPUFan/ SysFan Smart Fan Control	- Manual Duty Mode - Auto Duty-Cycle Mode	Smart Fan Mode select.
Manual Duty Mode	Duty value	Set duty cycle(PWM fan type) 1-100
Auto Duty- Cycle Mode	No selection	Fan speed up/down is determined by temperature



## 4-4-8. Network Stack

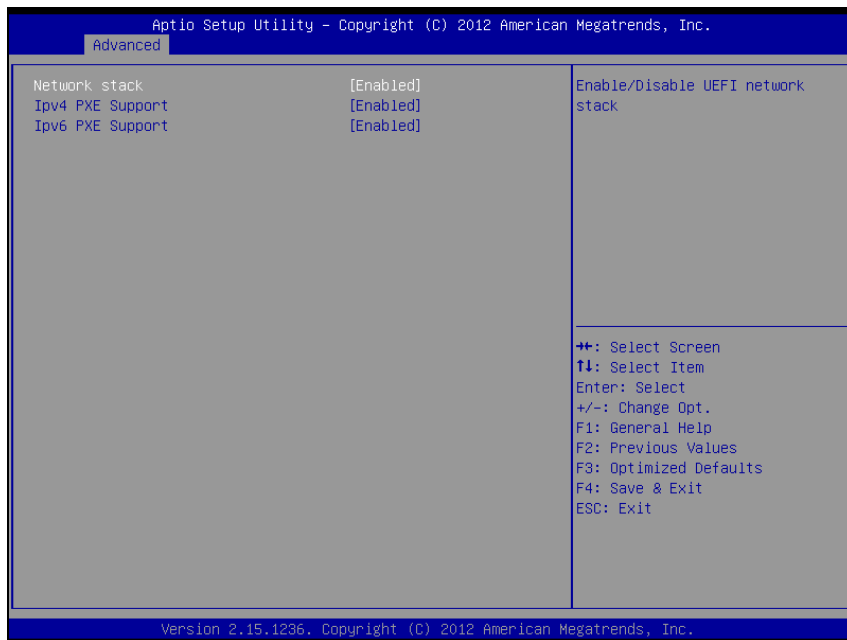

Network Stack screen

BIOS Setting	Options	Description/Purpose
Network stack	- Disabled - Enabled	Enable/Disable UEFI Network stack.
Ipv4/6 PXE Support	- Disabled - Enabled	Enable Ipv4/6 PXE boot support

## 4-4-9. Switchable Graphics

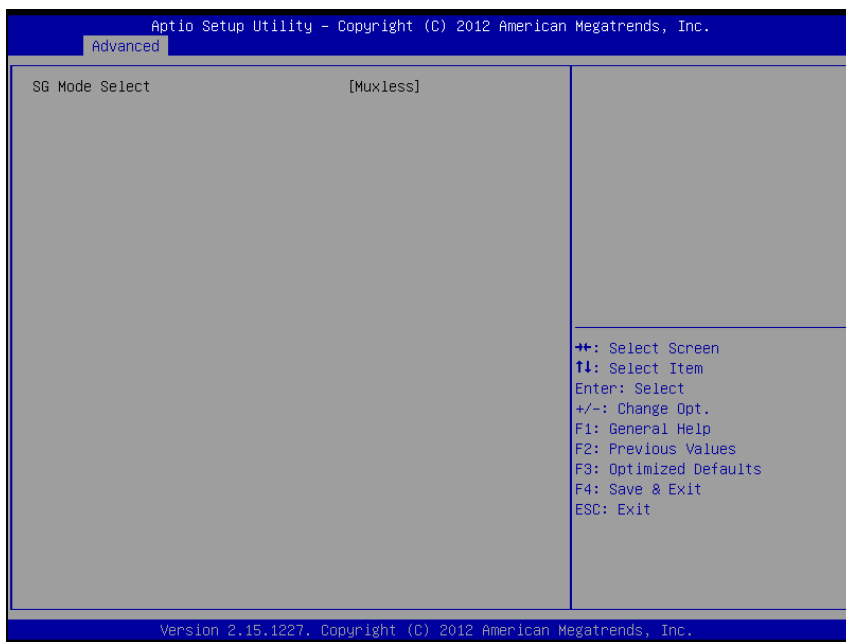

Network Stack screen

BIOS Setting	Options	Description/Purpose
SG Mode Select	- Muxless	Switchable Graphics selections

## 4-5. CHIPSET

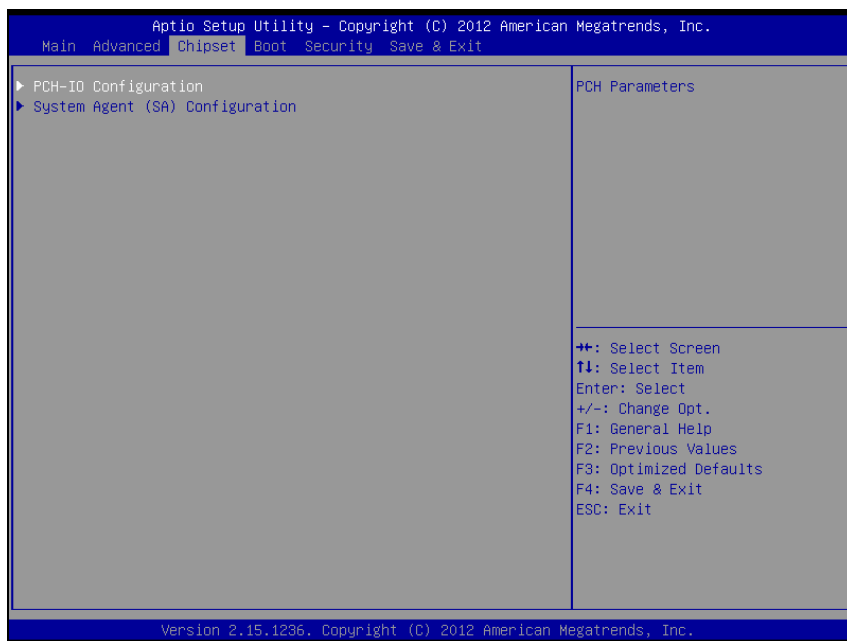

Chipset screen

BIOS Setting	Options	Description/Purpose
PCH-IO Configuration	Sub-menu	Sets Parameter for Panther Point (South Bridge) configuration.
System Agent (SA) Configuration	Sub-menu	Sets Parameter for Ivy Bridge (North Bridge) configuration.

## 4-5-1. PCH IO Configuration

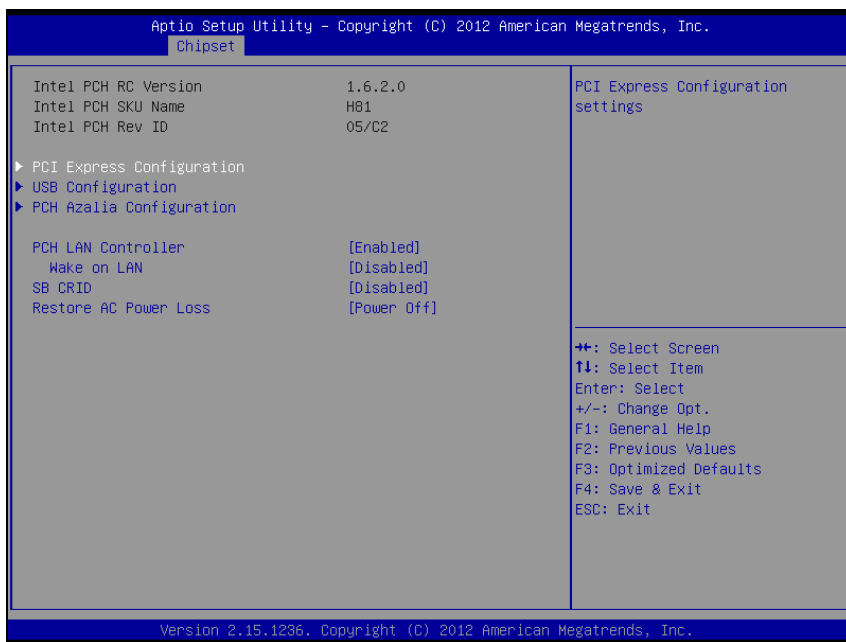

PCH IO Configuration screen

BIOS Setting	Options	Description/Purpose
Intel PCH RC Version	No changeable options	Displays the PCH source code module version
Intel PCH SKU Name	No changeable options	Displays PCH product SKU name.
Intel PCH Rev ID	No changeable options	Displays onboard PCH chip revision.
PCI Express Configuration	Sub-menu	PCI Express Configuration settings.
USB Configuration	Sub-menu	USB Configuration setting
PCH Azalia Configuration	Sub-menu	PCH Azalia Configuration settings.

<b>BIOS Setting</b>	<b>Options</b>	<b>Description/Purpose</b>
PCH LAN Controller	- Disabled - Enabled	Enable or disable onboard NIC
Wake on LAN	- Disabled - Enabled	Enable or disable integrated LAN to wake the system. (The Wake On LAN cannot be disabled if ME is on at Sx state.)
SB CRID	- Disabled - Enabled	Enable or disable SB CRID workaround
Restore AC Power Loss	- Power off - Power on	Select AC power state when power is re-applied after a power failure.

### 4-5-1-1. PCI Express Configuration

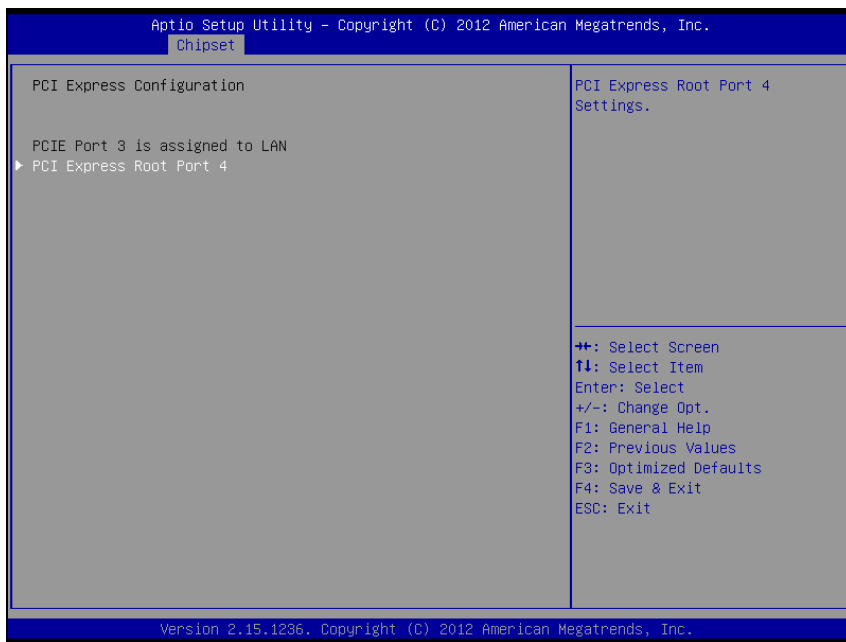

PCI Express Configuration screen

BIOS Setting	Options	Description/Purpose
PCIE Port 3 is assigned to LAN	No changeable options	Display LAN 1 is locate at PCIE port 3
PCI Express Root Port 4	- Disabled - Enabled	Enable or disable PCIE port 4 for LAN 2.

## 4-5-1-2. USB Configuration

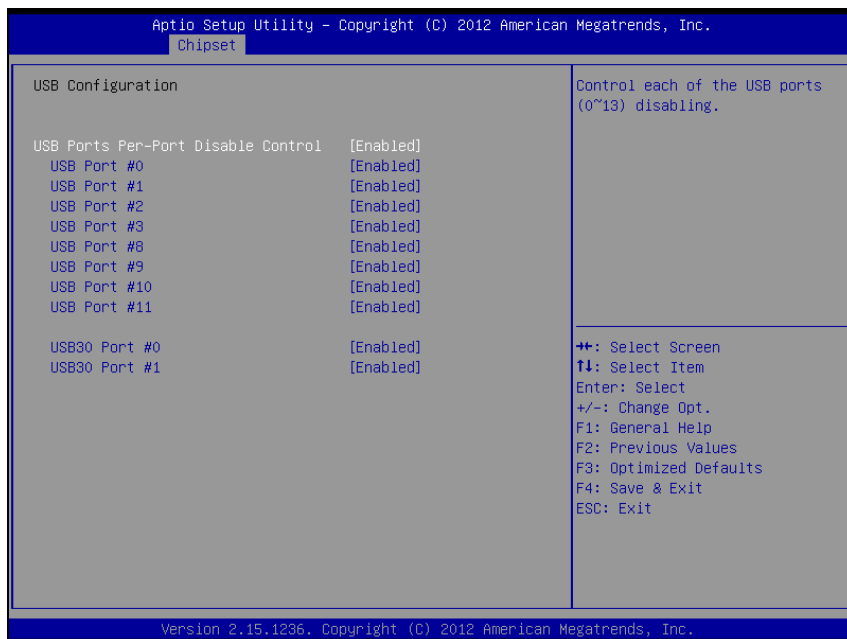

USB Configuration screen

BIOS Setting	Options	Description/Purpose
USB Ports Per-Port Disable Control	- Enabled - Disabled	Main control to enable or disable USB ports.
USB Port #0/1/2/3/8/9/10/11 USB30 Port #0/1	- Enabled - Disabled	Enable or disable each USB ports.

4-5-1-3. PCH Azalia Configuration

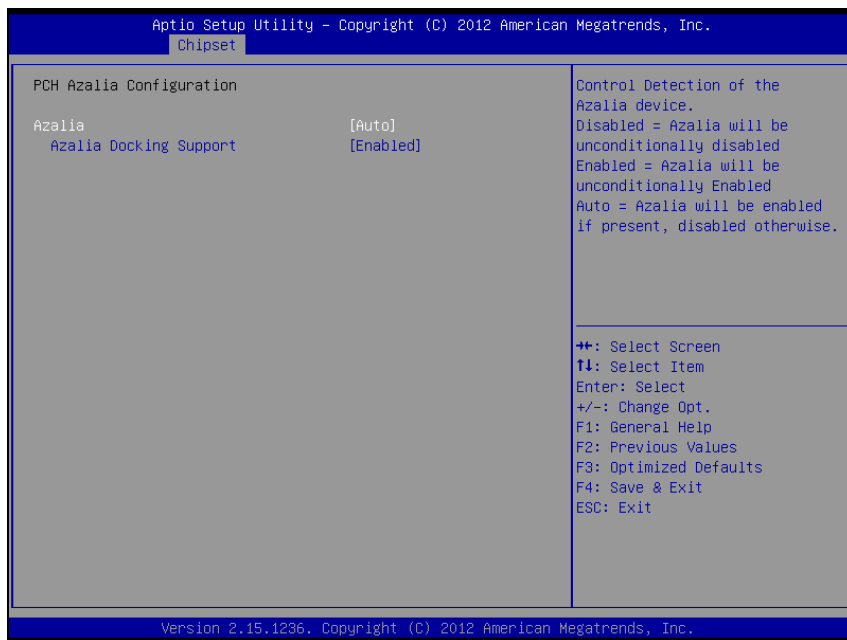

PCH Azalia Configuration screen

BIOS Setting	Options	Description/Purpose
Azalia	- Enabled - Disabled - Auto	Enable or disable internal HDMI codec for Azalia.
Azalia Docking Support	- Enabled - Disabled	Enable or disable Azalia Docking Support of Audio Controller



## 4-5-2. System Agent (SA) Configuration

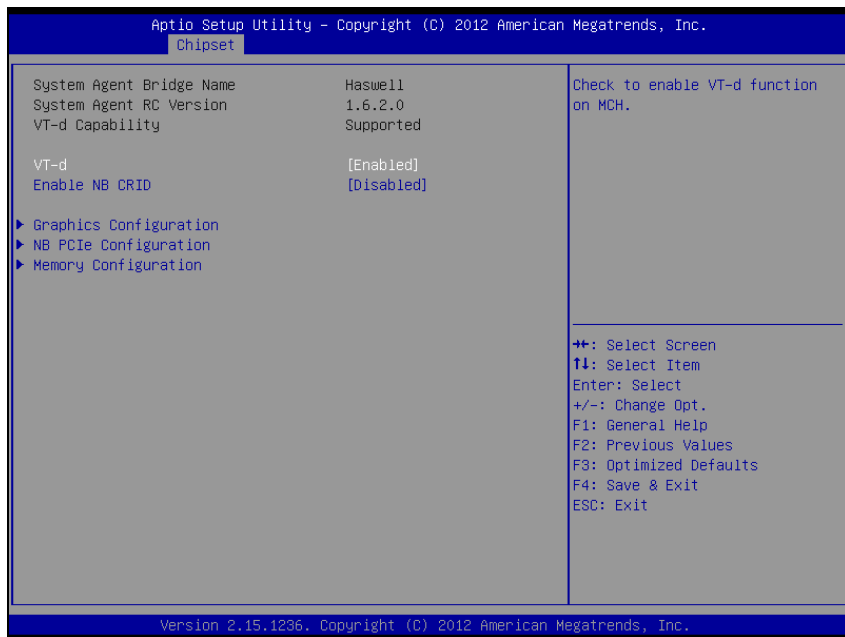

System Agent (SA) Configuration screen

BIOS Setting	Options	Description/Purpose
System Agent Bridge Name	No changeable options	Displays the system bridge name..
System Agent RC version	No changeable options	Displays the IVB source code module version
VT-d Capability	No changeable options	Report if VT-d support by processor
VT-d	- Enabled - Disabled	Enable or disable VT-d
Enable NB CRID	- Enabled - Disabled	Enable or disable NB CRID workaround.
Graphics Configuration	Sub-menu	Configure Graphic Settings.

<b>BIOS Setting</b>	<b>Options</b>	<b>Description/Purpose</b>
NB PCIe Configuration	Sub-menu	NB PCIe Configuration setting
Memory Configuration	Sub-menu	Memory Configuration Parameters

## 4-5-2-1. Graphics Configuration

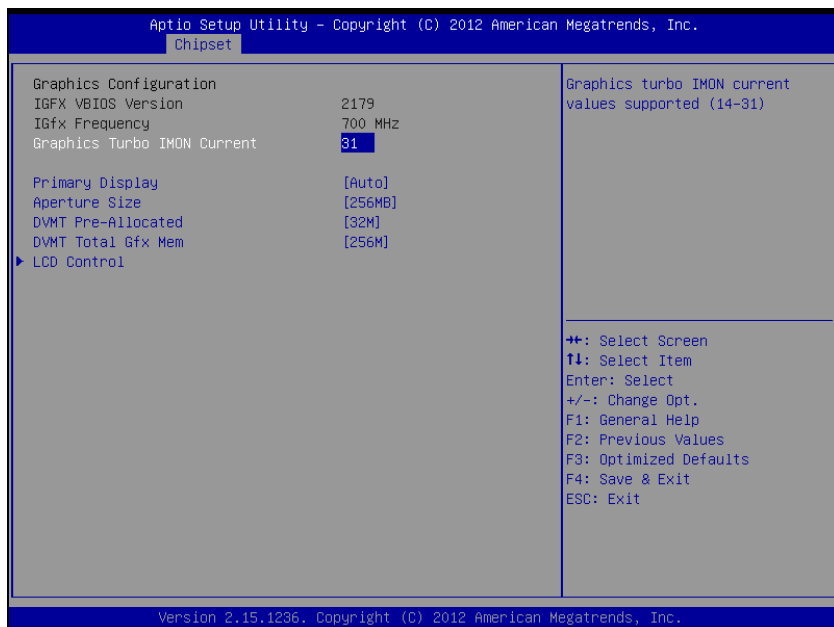

Graphics Configuration screen

BIOS Setting	Options	Description/Purpose
IGFX VBIOS Version	No changeable options	Displays the VBIOS version of integrated graphic controller.
IGfx Frequency	No changeable options	Displays the frequency integrated graphic controller.
Primary Display	- AUTO - IGFX - PEG	Select which of IGFX/PEG Graphics device should be Primary Display
Aperture Size	- 128MB - 256MB - 512MB	Select the Aperture Size
DVMT Pre-Allocated	- 32M ~ 1024M	Select DVMT 5.0 Pre-Allocated (Fixed) Graphics Memory size used by the Internal Graphics Device.

<b>BIOS Setting</b>	<b>Options</b>	<b>Description/Purpose</b>
DVMT Total Gfx Mem	- 128M - 256M - MAX	Intel Dynamic Video Memory Technology allows additional memory to be allocated for graphics usage based on application need. Once the application is closed, the memory that was allocated for graphics usage is then released and made available for system use.
LCD Control	Sub-menu	Display devices active selection

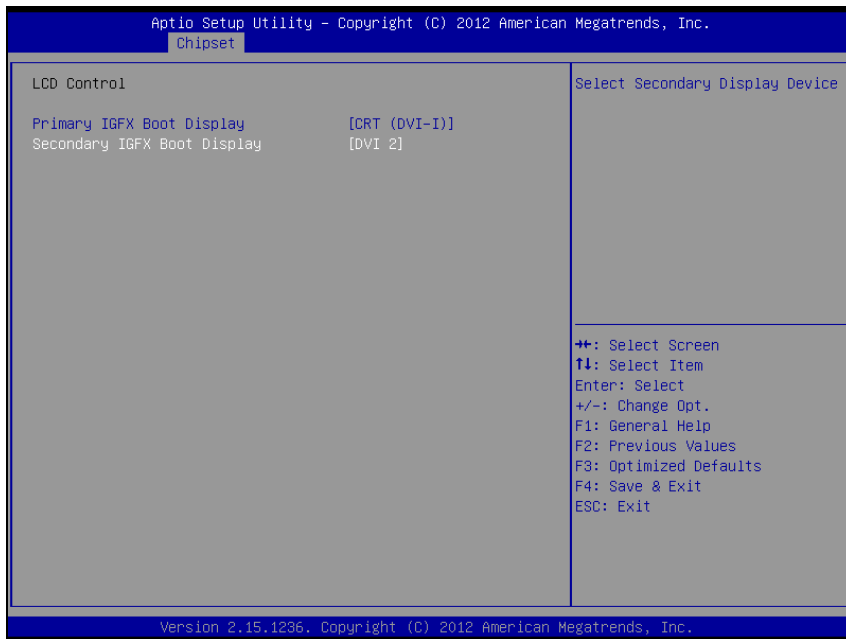

Graphics Configuration - LCD Control screen

BIOS Setting	Options	Description/Purpose
Primary IGFX Boot Display	<ul style="list-style-type: none"> <li>- VBIOS Default</li> <li>- CRT (DVI-I)</li> <li>- DVI 1 (DVI-I)</li> <li>- Onboard DP</li> <li>- DVI 2</li> </ul>	"Select the Video Device which will be activated during POST. This has no effect if external graphics present. Secondary boot display selection will appear based on your selection. VGA modes will be supported only on primary display"
Secondary IGFX Boot Display	<ul style="list-style-type: none"> <li>- Disabled</li> <li>- CRT (DVI-I)</li> <li>-DVI 1 (DVI-I)</li> <li>-Onboard DP</li> <li>- DVI 2</li> </ul>	Select Secondary Display Device

## 4-5-2-2. NB PCIe Configuration

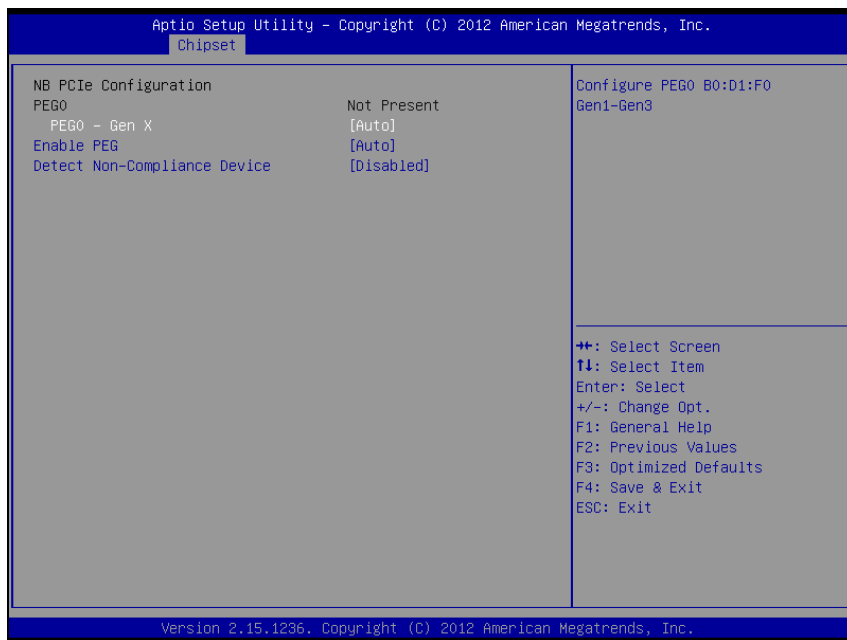

NB PCIe Configuration screen

BIOS Setting	Options	Description/Purpose
PEG0	No changeable options	Display PEG device exist
PEG0 – Gen X	- Auto - Gen1 - Gen2 - Gen3	Configure PEG0 Gen1~3
Enable PEG	- Disabled - Enabled - Auto	Enable or disable the PEG
Detect Non-Compliance Device	- Disabled - Enabled	Enable or disable Detect Non-Compliance Device in PEG

## 4-5-2-3. Memory Configuration

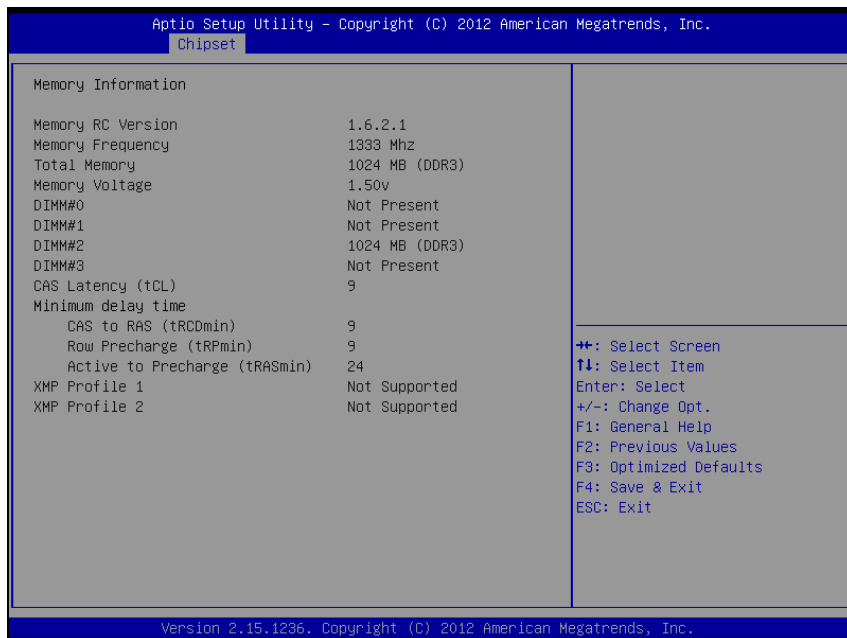

Memory Configuration screen

BIOS Setting	Options	Description/Purpose
Memory Information	No changeable option .	Displays the detail DRAM information on platform.

## 4-6. BOOT

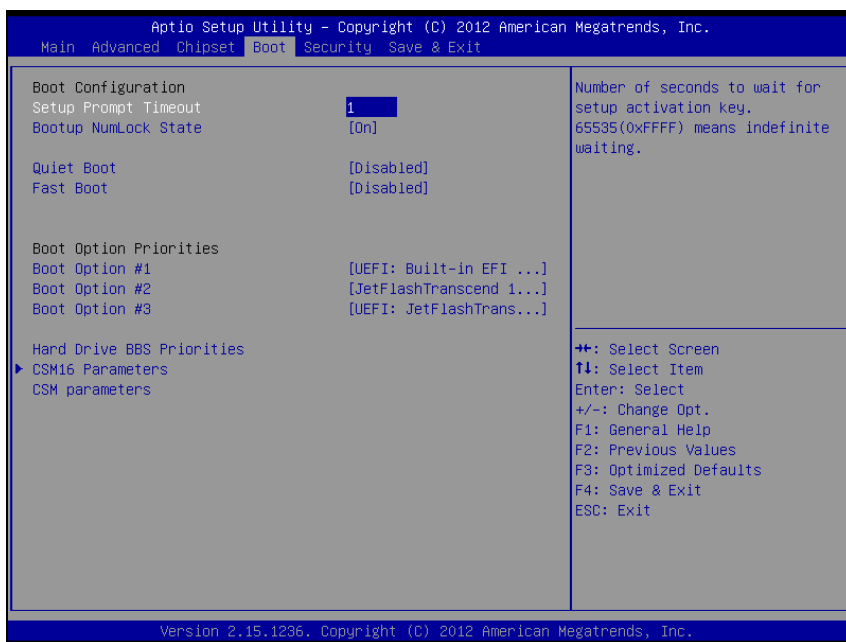

Boot screen

BIOS Setting	Options	Description/Purpose
Setup Prompt Timeout	Numeric	Number of seconds to wait for setup activation key.
Bootup NumLock Status	- On - Off	Specifies the power-on state of the NumLock Key.
Quiet Boot	- Disabled - Enabled	Enable/Disable Quiet Boot Options
Boot Option #1~#3	- [Drive(s)] - Disabled	Allows setting boot option listed in Hard Drive BBS Priorities.
CSM16 Parameters	Sub-menu	CSM features selection
CSM parameters	Sub-menu	CSM features selection



4-6-1. Hard Drive BBS Priorities

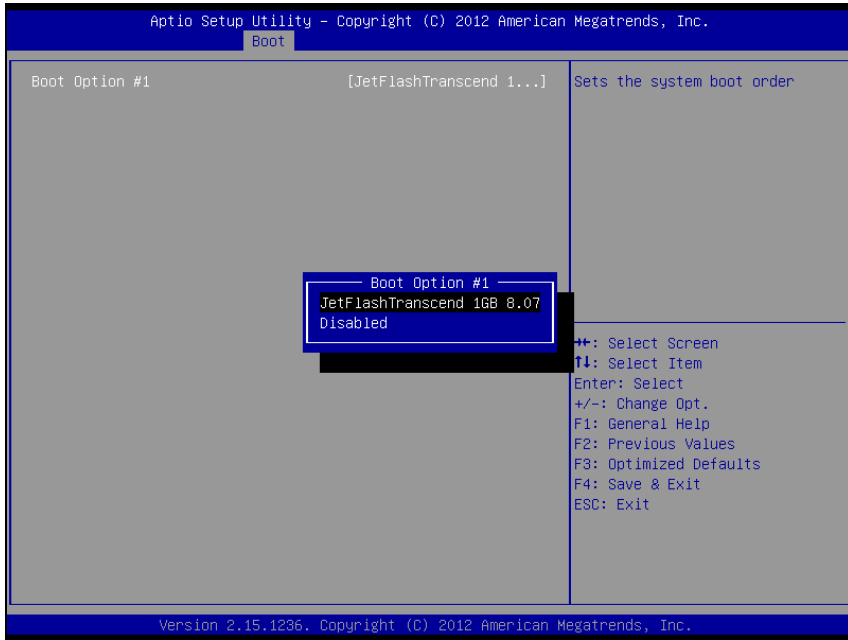

Hard Drive BBS Priorities screen

BIOS Setting	Options	Description/Purpose
Boot Option #1 - #3	- [Drive(s)] - Disabled	Allows setting the boot order of available drive(s).

## 4-6-2. CSM16 Parameters



CSM16 parameters screen

BIOS Setting	Options	Description/Purpose
CSM16 Module Version	78.d0	CSM version information
GateA20 Active	- Upon Request - Always	Specifies Gate-A20 logic gate status. At boot time, Gate-A20 is enabled when counting and testing of all the system's memory and disabled before transferring control to OS.
Option ROM Messages	- Force BIOS - Keep Current	Allows the POST screen to display Option ROM messages.
INT19 Trap Response	- Immediate - Postponed	When enabled it allows host adapters ROM BIOS to capture Interrupt 19 during the boot process and eventually boot from disk(s) connected to those adapters.

## 4-6-3. CSM Parameters

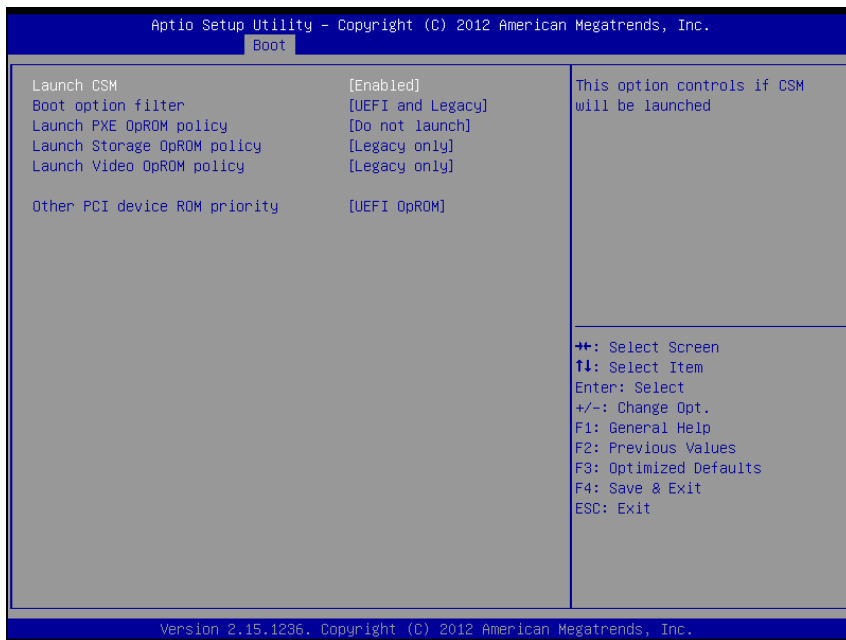

CSM parameters screen

BIOS Setting	Options	Description/Purpose
Launch CSM	- Disabled - Enabled	This option controls if CSM will be launched
Boot option filter	- UEFI and Legacy - Legacy only - UEFI only	Allows the system run the boot option rom type.
Launch PXE OpROM policy	- Do not launch - UEFI only - Legacy only	Controls the execution of UEFI and Legacy PXE OpROM
Launch Storage OpROM policy	- Do not launch - UEFI only - Legacy only	Controls the execution of UEFI and Legacy Storage OpROM

<b>BIOS Setting</b>	<b>Options</b>	<b>Description/Purpose</b>
Launch Video OpROM policy	<ul style="list-style-type: none"><li>- Do not launch</li><li>- UEFI only</li><li>- Legacy only</li><li>- Legacy first</li><li>- UEFI first</li></ul>	Controls the execution of UEFI and Legacy Video OpROM
Other PCI device ROM priority	<ul style="list-style-type: none"><li>- UEFI OpROM</li><li>- Legacy OpROM</li></ul>	For PCI devices other than Network, Mass storage or Video defines which OpROM to launch

## 4-7. SECURITY

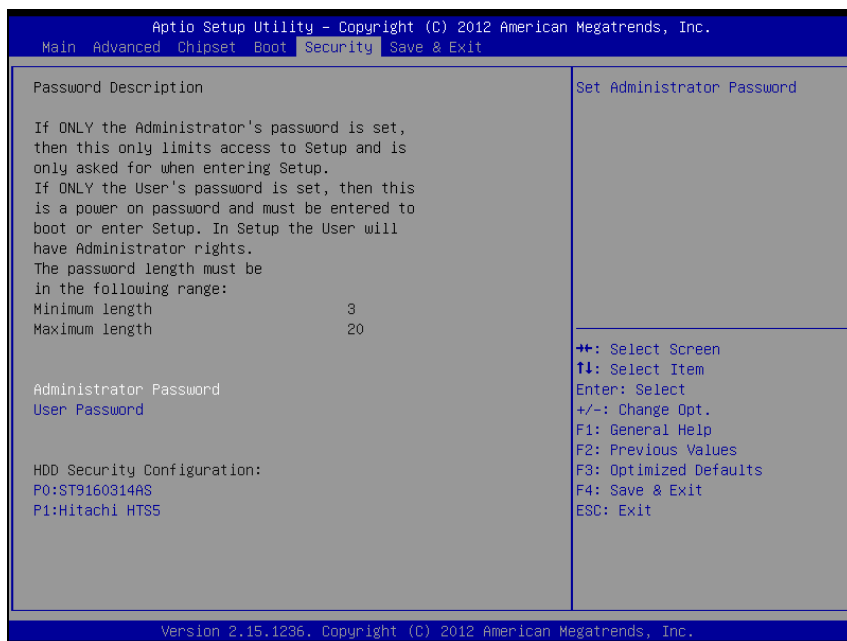

Security screen

BIOS Setting	Options	Description/Purpose
Administrator Password	Password can be 3-20 alphanumeric characters.	Specifies the administrator password.
User Password	Password can be 3-20 alphanumeric characters.	Specifies the user password.
HDD Security Configuration:	Sub-menu	Set HDD password.

## 4-7-1. HDD Security Configuration

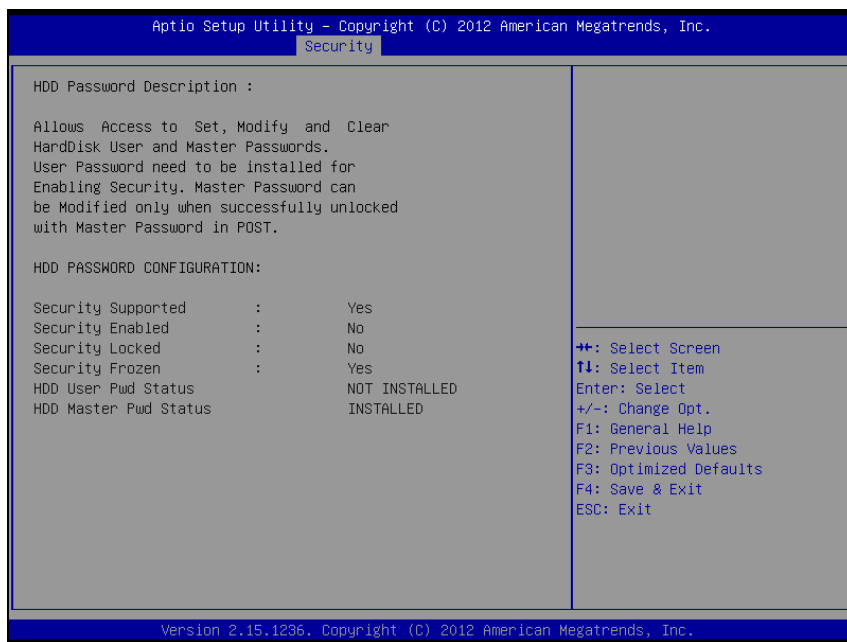

HDD Security Configuration screen

BIOS Setting	Options	Description/Purpose
Security Supported	No changeable options	Reports if there is security feature available.
Security Enabled	No changeable options	Reports if there is security feature enabled.
Security Locked	No changeable options	Reports if there is security feature locked.
Security Frozen	No changeable options	Reports if there is security feature frozen.
HDD User Pwd Status	No changeable options	Reports if there is HDD User Password installed.
HDD Master Pwd Status	No changeable options	Reports if there is HDD Master Password installed.

<b>BIOS Setting</b>	<b>Options</b>	<b>Description/Purpose</b>
Set User Password	Password can be up to 32 alphanumeric characters.	Specifies the user password. (Need TPM module)
Set Master Password	Password can be up to 32 alphanumeric characters.	Specifies the master password.

## 4-8. SAVE &amp; EXIT



Save &amp; Exit screen

BIOS Setting	Options	Description/Purpose
Save Changes and Exit	No changeable options	Exits and saves the changes in NVRAM.
Discard Changes and Exit	No changeable options	Exits without saving any changes made in BIOS settings.
Save Changes and Reset	No changeable options	Reset the system after saving the changes
Discard Changes and Reset	No changeable options	Reset system without saving any changes
Save Changes	No changeable options	Saves the changes done in BIOS settings so far.
Discard Changes	No changeable options	Discards the changes done in BIOS settings so far.



<b>BIOS Setting</b>	<b>Options</b>	<b>Description/Purpose</b>
Restore Defaults	No changeable options	Loads the optimized defaults for BIOS settings.
Save as User Defaults	No changeable options	Save the changes done so far as User Defaults
Restore User Defaults	No changeable options	Restore the User Defaults to all the setup options
Boot Override	- [Drive(s)]	Forces to boot from selected [drive(s)].

# ***EXPANSION BUS***

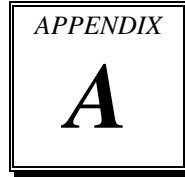

This appendix indicates the pin assignments of expansion bus.

Sections included:

- PCIe Bus

## PCI E BUS

You will find **PCI\_E1** with 164 pins on BM-0942.  
The pin assignments are as follows:

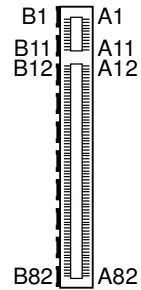

### PCI\_E1:

### PCI\_E1

A				B			
PIN	ASSIGNMENT	PIN	ASSIGNMENT	PIN	ASSIGNMENT	PIN	ASSIGNMENT
A1	Reserved	A42	GND	B1	+12V	B42	EXP_A_TX_6_D N
A2	+12V	A43	EXP_A_RX_6_D P	B2	+12V	B43	GND
A3	+12V	A44	EXP_A_RX_6_D N	B3	+12V	B44	GND
A4	GND	A45	GND	B4	GND	B45	EXP_A_TX_7_DP
A5	Reserved	A46	GND	B5	SMB_CLK	B46	EXP_A_TX_7_DN
A6	Reserved	A47	EXP_A_RX_7_D P	B6	SMB_DATA_	B47	GND
A7	Reserved	A48	EXP_A_RX_7_D N	B7	GND	B48	Reserved
A8	Reserved	A49	GND	B8	+3.3V	B49	GND
A9	+3.3V	A50	Reserved	B9	Reserved	B50	Reserved
A10	+3.3V	A51	Reserved	B10	+3.3SB	B51	Reserved
A11	PWRGD	A52	Reserved	B11	Wakeup	B52	Reserved
A12	GND	A53	Reserved	B12	Reserved	B53	Reserved
A13	PEG1_CLK_P	A54	Reserved	B13	GND	B54	Reserved
A14	PEG1_CLK_N	A55	Reserved	B14	EXP_A_TX_0_D P	B55	Reserved
A15	GND	A56	Reserved	B15	EXP_A_TX_0_D N	B56	Reserved
A16	EXP_A_RX_0_DP	A57	Reserved	B16	GND	B57	Reserved
A17	EXP_A_RX_0_DN	A58	Reserved	B17	PCIEX16_PRSN T2	B58	Reserved
A18	GND	A59	Reserved	B18	GND	B59	Reserved
A19	Reserved	A60	Reserved	B19	EXP_A_TX_1_D P	B60	Reserved
A20	GND	A61	Reserved	B20	EXP_A_TX_1_D N	B61	Reserved

A				B			
PIN	ASSIGNMENT	PIN	ASSIGNMENT	PIN	ASSIGNMENT	PIN	ASSIGNMENT
A21	EXP_A_RX_1_D P	A62	Reserved	B21	GND	B62	Reserved
A22	EXP_A_RX_1_D N	A63	Reserved	B22	GND	B63	Reserved
A23	GND	A64	Reserved	B23	EXP_A_TX_2_D P	B64	Reserved
A24	GND	A65	Reserved	B24	EXP_A_TX_2_D N	B65	Reserved
A25	EXP_A_RX_2_D P	A66	Reserved	B25	GND	B66	Reserved
A26	EXP_A_RX_2_D N	A67	Reserved	B26	GND	B67	Reserved
A27	GND	A68	Reserved	B27	EXP_A_TX_3_D P	B68	Reserved
A28	GND	A69	Reserved	B28	EXP_A_TX_3_D N	B69	Reserved
A29	EXP_A_RX_3_D P	A70	Reserved	B29	GND	B70	Reserved
A30	EXP_A_RX_3_D N	A71	Reserved	B30	Reserved	B71	Reserved
A31	GND	A72	Reserved	B31	Reserved	B72	Reserved
A32	Reserved	A73	Reserved	B32	GND	B73	Reserved
A33	Reserved	A74	Reserved	B33	EXP_A_TX_4_D P	B74	Reserved
A34	GND	A75	Reserved	B34	EXP_A_TX_4_D N	B75	Reserved
A35	EXP_A_RX_4_D P	A76	Reserved	B35	GND	B76	Reserved
A36	EXP_A_RX_4_D N	A77	Reserved	B36	GND	B77	Reserved
A37	GND	A78	Reserved	B37	EXP_A_TX_5_D P	B78	Reserved
A38	GND	A79	Reserved	B38	EXP_A_TX_5_D N	B79	Reserved
A39	EXP_A_RX_5_D P	A80	Reserved	B39	GND	B80	Reserved
A40	EXP_A_RX_5_D N	A81	Reserved	B40	GND	B81	Reserved
A41	GND	A82	Reserved	B41	EXP_A_TX_6_D P	B82	Reserved

# ***TECHNICAL SUMMARY***

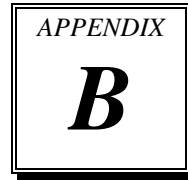

This section introduce you the maps concisely.

Sections included:

- Block Diagram
- Interrupt Map
- DMA Channel Map
- I/O Map
- Memory Map
- Watchdog Timer Configuration
- Flash BIOS Update

**BLOCK DIAGRAM**

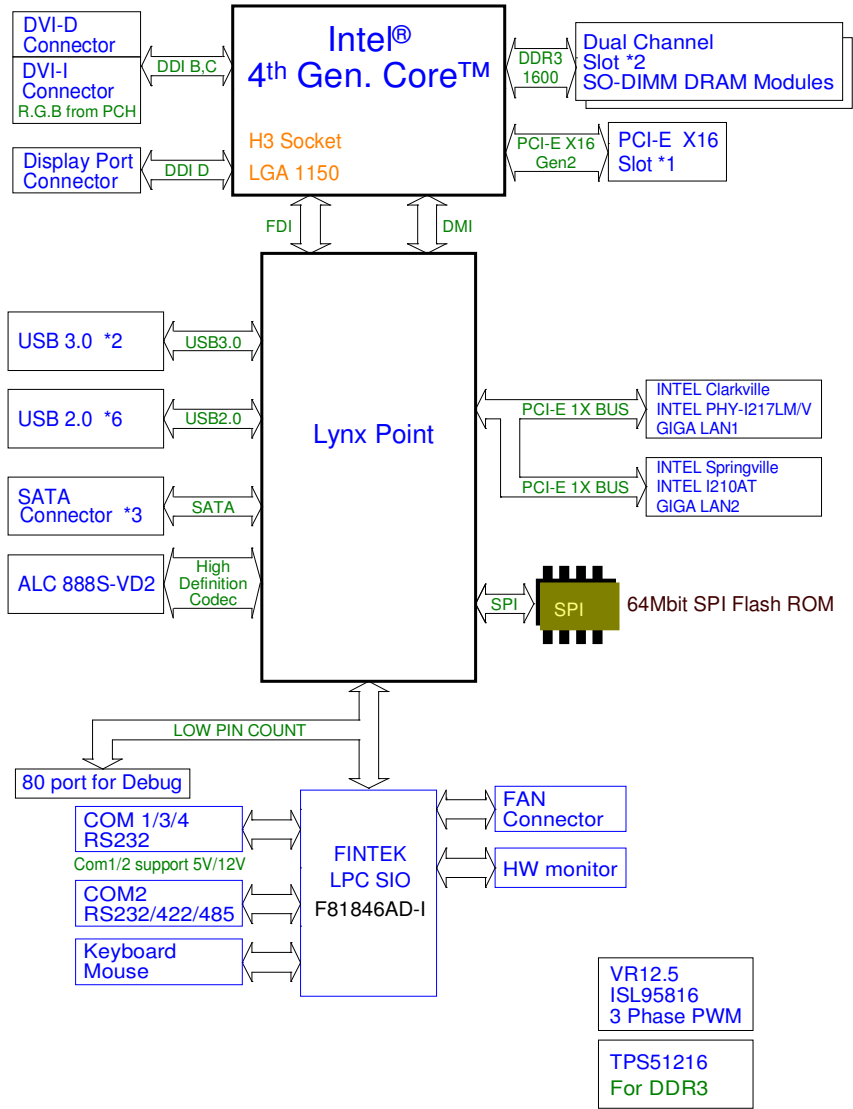

## INTERRUPT MAP

IRQ	ASSIGNMENT
0	System timer
1	Standard PS/2 Keyboard
3	Communications Port (COM2)
4	Communications Port (COM1)
5	Intel® 8 Series/C220 Series SMBus Controller - 8C22
7	Communications Port (COM3)
7	Communications Port (COM4)
8	System CMOS/real time clock
12	Microsoft PS/2 Mouse
13	Numeric data processor
16	Intel® 8 Series/C220 Series USB EHCI #2 - 8C2D
16	High Definition Audio Controller
19	Intel® 8 Series/C220 Series SATA AHCI Controller - 8C02
22	High Definition Audio Controller
23	Intel® 8 Series/C220 Series USB EHCI #1 - 8C26
81	Microsoft ACPI-Compliant System
82	Microsoft ACPI-Compliant System
83	Microsoft ACPI-Compliant System
84	Microsoft ACPI-Compliant System
85	Microsoft ACPI-Compliant System
86	Microsoft ACPI-Compliant System
87	Microsoft ACPI-Compliant System
88	Microsoft ACPI-Compliant System
89	Microsoft ACPI-Compliant System
90	Microsoft ACPI-Compliant System
91	Microsoft ACPI-Compliant System
92	Microsoft ACPI-Compliant System
93	Microsoft ACPI-Compliant System
94	Microsoft ACPI-Compliant System
95	Microsoft ACPI-Compliant System

<b>IRQ</b>	<b>ASSIGNMENT</b>
96	Microsoft ACPI-Compliant System
97	Microsoft ACPI-Compliant System
98	Microsoft ACPI-Compliant System
99	Microsoft ACPI-Compliant System
100	Microsoft ACPI-Compliant System
101	Microsoft ACPI-Compliant System
102	Microsoft ACPI-Compliant System
103	Microsoft ACPI-Compliant System
104	Microsoft ACPI-Compliant System
105	Microsoft ACPI-Compliant System
106	Microsoft ACPI-Compliant System
107	Microsoft ACPI-Compliant System
108	Microsoft ACPI-Compliant System
109	Microsoft ACPI-Compliant System
110	Microsoft ACPI-Compliant System
111	Microsoft ACPI-Compliant System
112	Microsoft ACPI-Compliant System
113	Microsoft ACPI-Compliant System
114	Microsoft ACPI-Compliant System
115	Microsoft ACPI-Compliant System
116	Microsoft ACPI-Compliant System
117	Microsoft ACPI-Compliant System
118	Microsoft ACPI-Compliant System
119	Microsoft ACPI-Compliant System
120	Microsoft ACPI-Compliant System
121	Microsoft ACPI-Compliant System
122	Microsoft ACPI-Compliant System
123	Microsoft ACPI-Compliant System
124	Microsoft ACPI-Compliant System
125	Microsoft ACPI-Compliant System
126	Microsoft ACPI-Compliant System
127	Microsoft ACPI-Compliant System



<b>IRQ</b>	<b>ASSIGNMENT</b>
128	Microsoft ACPI-Compliant System
129	Microsoft ACPI-Compliant System
130	Microsoft ACPI-Compliant System
131	Microsoft ACPI-Compliant System
132	Microsoft ACPI-Compliant System
133	Microsoft ACPI-Compliant System
134	Microsoft ACPI-Compliant System
135	Microsoft ACPI-Compliant System
136	Microsoft ACPI-Compliant System
137	Microsoft ACPI-Compliant System
138	Microsoft ACPI-Compliant System
139	Microsoft ACPI-Compliant System
140	Microsoft ACPI-Compliant System
141	Microsoft ACPI-Compliant System
142	Microsoft ACPI-Compliant System
143	Microsoft ACPI-Compliant System
144	Microsoft ACPI-Compliant System
145	Microsoft ACPI-Compliant System
146	Microsoft ACPI-Compliant System
147	Microsoft ACPI-Compliant System
148	Microsoft ACPI-Compliant System
149	Microsoft ACPI-Compliant System
150	Microsoft ACPI-Compliant System
151	Microsoft ACPI-Compliant System
152	Microsoft ACPI-Compliant System
153	Microsoft ACPI-Compliant System
154	Microsoft ACPI-Compliant System
155	Microsoft ACPI-Compliant System
156	Microsoft ACPI-Compliant System
157	Microsoft ACPI-Compliant System
158	Microsoft ACPI-Compliant System
159	Microsoft ACPI-Compliant System

<b>IRQ</b>	<b>ASSIGNMENT</b>
160	Microsoft ACPI-Compliant System
161	Microsoft ACPI-Compliant System
162	Microsoft ACPI-Compliant System
163	Microsoft ACPI-Compliant System
164	Microsoft ACPI-Compliant System
165	Microsoft ACPI-Compliant System
166	Microsoft ACPI-Compliant System
167	Microsoft ACPI-Compliant System
168	Microsoft ACPI-Compliant System
169	Microsoft ACPI-Compliant System
170	Microsoft ACPI-Compliant System
171	Microsoft ACPI-Compliant System
172	Microsoft ACPI-Compliant System
173	Microsoft ACPI-Compliant System
174	Microsoft ACPI-Compliant System
175	Microsoft ACPI-Compliant System
176	Microsoft ACPI-Compliant System
177	Microsoft ACPI-Compliant System
178	Microsoft ACPI-Compliant System
179	Microsoft ACPI-Compliant System
180	Microsoft ACPI-Compliant System
181	Microsoft ACPI-Compliant System
182	Microsoft ACPI-Compliant System
183	Microsoft ACPI-Compliant System
184	Microsoft ACPI-Compliant System
185	Microsoft ACPI-Compliant System
186	Microsoft ACPI-Compliant System
187	Microsoft ACPI-Compliant System
188	Microsoft ACPI-Compliant System
189	Microsoft ACPI-Compliant System
190	Microsoft ACPI-Compliant System
4294967283	Intel® I210 Gigabit Network Connection #3

<b>IRQ</b>	<b>ASSIGNMENT</b>
4294967284	Intel® I210 Gigabit Network Connection #3
4294967285	Intel® I210 Gigabit Network Connection #3
4294967286	Intel® I210 Gigabit Network Connection #3
4294967287	Intel® I210 Gigabit Network Connection #3
4294967288	Intel® I210 Gigabit Network Connection #3
4294967289	Intel® Ethernet Connection I217-LM
4294967290	Intel® Management Engine Interface
4294967291	Intel® USB 3.0 eXtensible Host Controller
4294967292	Intel® HD Graphics 4600
4294967293	Intel® 8 Series/C220 Series PCI Express Root Port #4 - 8C16
4294967294	Intel® 8 Series/C220 Series PCI Express Root Port #1 - 8C10

**Note:** These resource information were gathered on Windows 7 (the IRQ could be assigned differently depending on your OS.)

## **DMA CHANNELS MAP**

<b>TIMER CHANNEL</b>	<b>ASSIGNMENT</b>
Channel 4	Direct memory access controller

## I/O MAP

I/O MAP	ASSIGNMENT
0x00000000-0x0000001F	Direct memory access controller
0x00000000-0x0000001F	PCI bus
0x00000010-0x0000001F	Motherboard resources
0x00000020-0x00000021	Programmable interrupt controller
0x00000022-0x0000003F	Motherboard resources
0x00000024-0x00000025	Programmable interrupt controller
0x00000028-0x00000029	Programmable interrupt controller
0x0000002C-0x0000002D	Programmable interrupt controller
0x0000002E-0x0000002F	Motherboard resources
0x00000030-0x00000031	Programmable interrupt controller
0x00000034-0x00000035	Programmable interrupt controller
0x00000038-0x00000039	Programmable interrupt controller
0x0000003C-0x0000003D	Programmable interrupt controller
0x00000040-0x00000043	System timer
0x00000044-0x0000005F	Motherboard resources
0x0000004E-0x0000004F	Motherboard resources
0x00000050-0x00000053	System timer
0x00000060-0x00000060	Standard PS/2 Keyboard
0x00000061-0x00000061	Motherboard resources
0x00000062-0x00000063	Motherboard resources
0x00000063-0x00000063	Motherboard resources
0x00000064-0x00000064	Standard PS/2 Keyboard
0x00000065-0x0000006F	Motherboard resources
0x00000065-0x0000006F	Motherboard resources
0x00000067-0x00000067	Motherboard resources
0x00000070-0x00000070	Motherboard resources
0x00000070-0x00000070	System CMOS/real time clock
0x00000072-0x0000007F	Motherboard resources
0x00000080-0x00000080	Motherboard resources
0x00000080-0x00000080	Motherboard resources

<b>I/O MAP</b>	<b>ASSIGNMENT</b>
0x00000081-0x00000091	Direct memory access controller
0x00000084-0x00000086	Motherboard resources
0x00000088-0x00000088	Motherboard resources
0x0000008C-0x0000008E	Motherboard resources
0x00000090-0x0000009F	Motherboard resources
0x00000092-0x00000092	Motherboard resources
0x00000093-0x0000009F	Direct memory access controller
0x000000A0-0x000000A1	Programmable interrupt controller
0x000000A2-0x000000BF	Motherboard resources
0x000000A4-0x000000A5	Programmable interrupt controller
0x000000A8-0x000000A9	Programmable interrupt controller
0x000000AC-0x000000AD	Programmable interrupt controller
0x000000B0-0x000000B1	Programmable interrupt controller
0x000000B2-0x000000B3	Motherboard resources
0x000000B4-0x000000B5	Programmable interrupt controller
0x000000B8-0x000000B9	Programmable interrupt controller
0x000000BC-0x000000BD	Programmable interrupt controller
0x000000C0-0x000000DF	Direct memory access controller
0x000000E0-0x000000EF	Motherboard resources
0x000000F0-0x000000F0	Numeric data processor
0x000002E8-0x000002EF	Communications Port (COM4)
0x000002F8-0x000002FF	Communications Port (COM2)
0x000003B0-0x000003BB	Intel® HD Graphics 4600
0x000003C0-0x000003DF	Intel® HD Graphics 4600
0x000003E8-0x000003EF	Communications Port (COM3)
0x000003F8-0x000003FF	Communications Port (COM1)
0x000004D0-0x000004D1	Motherboard resources
0x000004D0-0x000004D1	Programmable interrupt controller
0x00000680-0x0000069F	Motherboard resources
0x00000A00-0x00000A0F	Motherboard resources
0x00000A10-0x00000A1F	Motherboard resources
0x00000A20-0x00000A2F	Motherboard resources

<b>I/O MAP</b>	<b>ASSIGNMENT</b>
0x00000D00-0x0000FFFF	PCI bus
0x0000164E-0x0000164F	Motherboard resources
0x00001800-0x000018FE	Motherboard resources
0x00001854-0x00001857	Motherboard resources
0x00001C00-0x00001CFE	Motherboard resources
0x00001D00-0x00001DFE	Motherboard resources
0x00001E00-0x00001EFE	Motherboard resources
0x00001F00-0x00001FFE	Motherboard resources
0x0000E000-0x0000EFFF	Intel® 8 Series/C220 Series PCI Express Root Port #4 - 8C16
0x0000F000-0x0000F03F	Intel® HD Graphics 4600
0x0000F040-0x0000F05F	Intel® 8 Series/C220 Series SMBus Controller - 8C22
0x0000F060-0x0000F07F	Intel® 8 Series/C220 Series SATA AHCI Controller - 8C02
0x0000F0A0-0x0000F0A3	Intel® 8 Series/C220 Series SATA AHCI Controller - 8C02
0x0000F0B0-0x0000F0B7	Intel® 8 Series/C220 Series SATA AHCI Controller - 8C02
0x0000F0C0-0x0000F0C3	Intel® 8 Series/C220 Series SATA AHCI Controller - 8C02
0x0000F0D0-0x0000F0D7	Intel® 8 Series/C220 Series SATA AHCI Controller - 8C02
0x0000FFFF-0x0000FFFF	Motherboard resources
0x0000FFFF-0x0000FFFF	Motherboard resources
0x0000FFFF-0x0000FFFF	Motherboard resources

## MEMORY MAP

MEMORY MAP	ASSIGNMENT
0xFED40000-0xFED44FFF	System board
0xFED1C000-0xFED1FFFF	Motherboard resources
0xFED10000-0xFED17FFF	Motherboard resources
0xFED18000-0xFED18FFF	Motherboard resources
0xFED19000-0xFED19FFF	Motherboard resources
0xF8000000-0xFBFFFFFF	Motherboard resources
0xFED20000-0xFED3FFFF	Motherboard resources
0xFED90000-0xFED93FFF	Motherboard resources
0xFED45000-0xFED8FFFF	Motherboard resources
0xFF000000-0xFFFFFFFF	Motherboard resources
0xFF000000-0xFFFFFFFF	Intel® 82802 Firmware Hub Device
0xFEE00000-0xFEEFFFFFF	Motherboard resources
0xF7FDF000-0xF7FDFFF	Motherboard resources
0xF7FE0000-0xF7FEFFF	Motherboard resources
0xF7C00000-0xF7C7FFF	Intel® I210 Gigabit Network Connection #3
0xF7C00000-0xF7C7FFF	Intel® 8 Series/C220 Series PCI Express Root Port #4 - 8C16
0xF7C80000-0xF7C83FFF	Intel® I210 Gigabit Network Connection #3
0xF7D3B000-0xF7D3B3FF	Intel® 8 Series/C220 Series USB EHCI #1 - 8C26
0xF7D3C000-0xF7D3C3FF	Intel® 8 Series/C220 Series USB EHCI #2 - 8C2D
0xF7D00000-0xF7D1FFFF	Intel® Ethernet Connection I217-LM
0xF7D3D000-0xF7D3DFFF	Intel® Ethernet Connection I217-LM
0xF7D20000-0xF7D2FFFF	Intel® USB 3.0 eXtensible Host Controller
0xF7D3A000-0xF7D3A7FF	Intel® 8 Series/C220 Series SATA AHCI Controller - 8C02
0xF7D3F000-0xF7D3F00F	Intel® Management Engine Interface
0xFED00000-0xFED003FF	High precision event timer
0xF7800000-0xF7BFFFFFF	Intel® HD Graphics 4600
0xE0000000-0xEFFFFFFF	Intel® HD Graphics 4600
0xF7D34000-0xF7D37FFF	High Definition Audio Controller



<b>MEMORY MAP</b>	<b>ASSIGNMENT</b>
0xF7D30000-0xF7D33FFF	High Definition Audio Controller
0xF7D39000-0xF7D390FF	Intel® 8 Series/C220 Series SMBus Controller - 8C22
0xA0000-0xBFFFF	Intel® HD Graphics 4600
0xA0000-0xBFFFF	PCI bus
0xD0000-0xD3FFF	PCI bus
0xD4000-0xD7FFF	PCI bus
0xD8000-0xDBFFF	PCI bus
0xDC000-0xDFFFF	PCI bus
0xE0000-0xE3FFF	PCI bus
0xE4000-0xE7FFF	PCI bus
0x3E200000-0xFEAF0000	PCI bus

## **WATCHDOG TIMER CONFIGURATION**

The I/O port address of the watchdog timer is 2E (hex) and 2F (hex). 2E (hex) is the address port. 2F (hex) is the data port. User must first assign the address of register by writing address value into address port 2E (hex), then write/read data to/from the assigned register through data port 2F (hex).

### **Configuration Sequence**

To program F81866 configuration registers, the following configuration sequence must be followed:

1. Enter the extended function mode

To place the chip into the Extended Function Mode, two successive writes of 0x87 must be applied to Extended Function Enable Registers (EFERs, i.e. 2Eh or 4Eh).

2. Configure the configuration registers

The chip selects the Logical Device and activates the desired Logical Devices through Extended Function Index Register (EFIR) and Extended Function Data Register (EFDR). The EFIR is located at the same address as the EFER, and the EFDR is located at address (EFIR+1). First, write the Logical Device Number (i.e. 0x07) to the EFIR and then write the number of the desired Logical Device to the EFDR. If accessing the Chip (Global) Control Registers, this step is not required. Secondly, write the address of the desired configuration register within the Logical Device to the EFIR and then write (or read) the desired configuration register through the EFDR.

3. Exit the extended function mode

To exit the Extended Function Mode, writing 0xAA to the EFER is required. Once the chip exits the Extended Function Mode, it is in the normal running mode and is ready to enter the configuration mode.

## Example Program

Enable watchdog timer and set the timeout interval as 30 seconds.

```
;----- Enter to extended function mode -----  
mov  dx,    2eh  
mov  al,    87h  
out  dx,    al  
out  dx,    al  
;----- Select Logical Device 7 of watchdog timer -----  
mov  al,    07h  
out  dx,    al  
inc  dx  
mov  al,    07h  
out  dx,    al  
;----- Enable Watch dog feature -----  
mov  al,    30h  
out  dx,    al  
inc  dx  
mov  al,    01h  
out  dx,    al  
;----- Enable Watch PME-----  
dec  dx  
mov  al,    0FAh  
out  dx,    al  
inc  dx  
in   al,    dx  
and  al,    51h  
out  dx,    al  
;----- Set second as counting unit -----  
dec  dx  
mov  al,    0f5h  
out  dx,    al  
inc  dx
```

```
in    al,    dx
and   al,    20h
out   dx,    al
```

```
;----- Set timeout interval as 30seconds and start counting -----
```

```
dec   dx
mov   al,    0f6h
out   dx,    al
inc   dx
mov   al,    1Eh
out   dx,    al
```

```
;----- Exit the extended function mode -----
```

```
dec   dx
mov   al,    0aah
out   dx,    al
```

## Flash BIOS Update

### I. Before System BIOS update

1. Prepare a bootable media (ex. USB storage device) which can boot system to DOS prompt.
2. Download and save the BIOS file (ex. M9420TH6.bin) to the bootable device.
3. Copy AMI flash utility – AFUDOS.exe (V3.05.02) into bootable device.
4. Make sure the target system can first boot to the bootable device.
  - a. Connect the bootable USB device.
  - b. Turn on the computer and press <Del> or <ESC> key during boot to enter BIOS Setup.
  - c. System will go into the BIOS setup menu.
  - d. Select [Boot] menu.
  - e. Select [Hard Drive BBS Priorities], set the USB bootable device to be the 1<sup>st</sup> boot device.
  - f. Press <F4> key to save configuration and exit the BIOS setup menu.

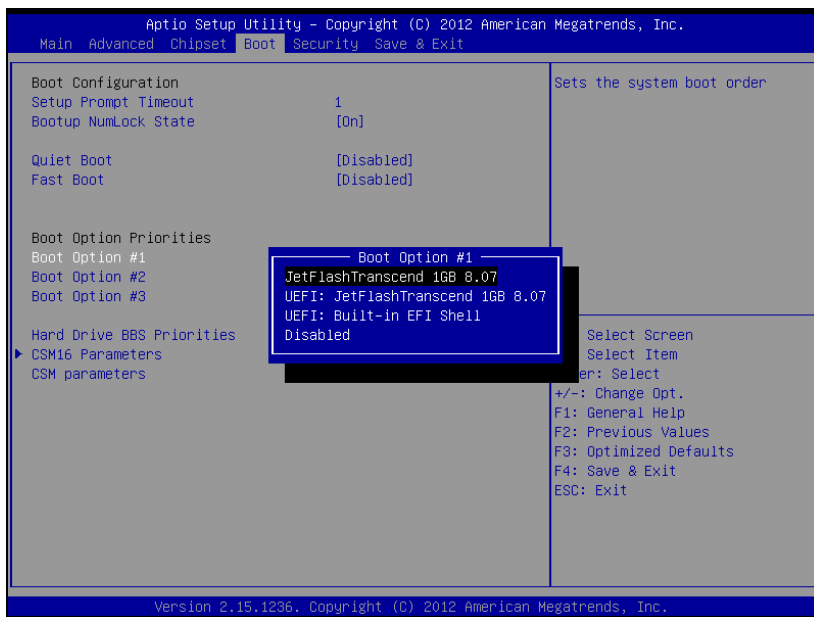

## II. AFUDOS Command for System BIOS Update

AFUDOS.exe is the AMI firmware update utility; the command line is shown as below:

**AFUDOS <ROM File Name> [option1] [option2]...**

You can type **AFUDOS /?** to see all the definition of each control options. The recommended options for BIOS ROM update consist of following parameters:

**/P:** program main BIOS image

**/B:** program Boot Block

**/N:** program NVRAM

**/X:** don't check ROM ID

### III. BIOS update procedure

1. Use the bootable USB device to boot up system into the MS-DOS command prompt.
2. Type in `AFUDOS M942xxxx.bin /p /b /n /x` and press enter to start the flash procedure.

**Note:** `xxxx` means the BIOS revision part, ex. 0PW1...

3. During the update procedure, you will see the BIOS update process status and its percentage. Beware! Do not turn off system power or reset your computer if the whole procedure are not complete yet, or it may crash the BIOS ROM and make system unable to boot up next time.
4. After BIOS update procedures is complete, the messages should be like the figure shown below:

```
C:\AFUDOS>afudos M942TH6.bin /p /b /n /x
-----+
|                                     |
|             AMI Firmware Update Utility v3.05.02             |
|             Copyright (C)2013 American Megatrends Inc. All Rights Reserved. |
|-----+
| Reading flash ..... done |
| - ME Data Size checking . ok |
| - FFS checksums ..... ok |
| Erasing Boot Block ..... done |
| Updating Boot Block ..... done |
| Verifying Boot Block ..... done |
| Erasing Main Block ..... done |
| Updating Main Block ..... done |
| Verifying Main Block ..... done |
| Erasing NVRAM Block ..... done |
| Updating NVRAM Block ..... done |
| Verifying NVRAM Block ..... done |
|
| C:\AFUDOS>
```

5. You can restart the system and boot up with new BIOS now.
6. Update is complete after restart.

7. Verify during following boot that the BIOS version displayed at initialization screen has changed.

