

USER MANUAL

BS-E098
Fanless Embedded PC
with Intel® Apollo Lake
Pentium™ / Celeron® SoC

BS-E098 M2

BS-E098

Fanless Embedded PC with Intel[®] Apollo Lake Pentium[™] / Celeron[®] SoC

COPYRIGHT NOTICE & TRADEMARK

All trademarks and registered trademarks mentioned herein are the property of their respective owners.

This manual is copyrighted in July 2018. You may not reproduce or transmit in any form or by any means, electronic, or mechanical, including photocopying and recording.

DISCLAIMER

This user's manual is meant to assist users in installing and setting up the system. The information contained in this document is subject to change without any notice.

CE NOTICE

This is a class A product. In a domestic environment this product may cause radio interference in which case the user may be required to take adequate measures.

FCC NOTICE

This equipment has been tested and found to comply with the limits for a Class A digital device, pursuant to part 15 of the FCC Rules. These limits are designed to provide reasonable protection against harmful interference when the equipment is operated in a commercial environment. This equipment generates, uses, and can radiate radio frequency energy and, if not installed and used in accordance with the instruction manual, may cause harmful interference to radio communications. Operation of this equipment in a residential area is likely to cause harmful interference in which case the user will be required to correct the interference at his own expense.

You are cautioned that any change or modifications to the equipment not expressly approve by the party responsible for compliance could void your authority to operate such equipment.

	<p>CAUTION: Danger of explosion may occur when the battery is incorrectly replaced. Replace the battery only with the same or equivalent type recommended by the manufacturer. Dispose of used batteries according to the manufacturer's instructions.</p>
---	---

	<p>WARNING: Some internal parts of the system may have high electrical voltage. We strongly recommend that only qualified engineers are allowed to service and disassemble the system. If any damages should occur on the system and are caused by unauthorized servicing, it will not be covered by the product warranty.</p>
--	---

Contents

Revision History	v
1 Introduction	1-1
1.1 About This Manual	1-2
2 Getting Started	2-1
2.1 Packing List	2-2
2.2 System Overview	2-3
2.2.1 Front View	2-3
2.2.2 Rear View	2-3
2.2.3 Top View	2-4
2.2.4 Side View	2-4
2.2.5 Bottom View	2-5
2.2.6 Quarter View	2-6
2.3 System Specifications	2-7
2.4 Safety Precautions	2-9
3 System Configuration	3-1
3.1 External System I/O Ports Diagrams	3-2
3.1.1 Front I/O Ports Diagram	3-2
3.1.2 Rear I/O Ports Diagram	3-2
3.2 JUMPER & CONNECTOR QUICK REFERENCE TABLE	3-3
3.3 COMPONENT LOCATIONS OF SYSTEM MAIN BOARD	3-4
3.3.1 Top View of System Main Board (BE-0981RA-**N)	3-4
3.3.2 Jumper Setting of System Main Board (BE-0981RA-**N)	3-5
3.3.3 Bottom View of System Main Board (BE-0981RA-N0N/ BE-0981RA-N1N)	3-6

3.3.4	HOW TO SET JUMPERS.....	3-7
3.4	Setting Connectors and Jumpers.....	3-9
3.4.1	COM3 and COM4 PIN9 Definition Selection Guide	3-9
3.4.2	COM PORT	3-10
3.4.3	DC-IN 3-Pin Terminal Block.....	3-12
3.4.4	VGA PORT	3-12
3.4.5	DISPLAY PORT.....	3-13
3.4.6	LAN PORT.....	3-14
3.4.7	DUAL USB 3.0 PORT (USB1).....	3-15
3.4.8	USB 3.0 PORT (USB2)	3-15
3.4.9	Programmable DIGITAL I/O PIN HEADER	3-17
3.4.10	I2C WAFER	3-17
3.4.11	SYSTEM FAN CONNECTOR	3-18
3.4.12	DC POWER INPUT CONNECTOR.....	3-18
3.4.13	MINI PCI EXPRESS SLOT	3-19
3.4.14	mSATA Connector	3-20
3.4.15	LVDS CONNECTOR	3-21
3.4.16	FRONT PANEL CONNECTOR.....	3-22
3.4.17	HD AUDIO CONNECTOR.....	3-22
3.4.18	PANEL INVERTER CONNECTOR.....	3-23
3.4.19	SATA 3.0 CONNECTOR.....	3-23
3.4.20	SATA Power CONNECTOR	3-23
3.4.21	BIOS RESET CONNECTOR.....	3-24
3.4.22	LVDS BACKLIGHT CONTROL SELECTION.....	3-24
3.4.23	LVDS VCC VOLTAGE SELECTION.....	3-25
3.4.24	CLEAR CMOS DATA SELECTION	3-26
4	Software Utilities	4-1
4.1	Introduction.....	4-2

4.2	Installing Intel® Chipset Software Installation Utility	4-3
4.3	Installing Graphics Driver Utility	4-4
4.4	Installing LAN Driver Utility	4-5
4.5	Installing Sound Driver Utility	4-6
5	BIOS SETUP	5-1
5.1	Introduction.....	5-2
5.2	Accessing Setup Utility.....	5-3
5.3	Main.....	5-6
5.4	Advanced	5-8
5.4.1	Advanced - ACPI Settings	5-9
5.4.2	Advanced – Onboard Device Configuration	5-10
5.4.3	Advanced – Hardware Monitor	5-11
5.4.4	Advanced - F81846 Watchdog	5-12
5.4.5	Advanced - S5 RTC Wake Settings	5-13
	S5 RTC Wake Settings [Fixed Time]	5-14
	S5 RTC Wake Settings [Dynamic Time].....	5-15
5.4.6	Advanced - CPU Configuration	5-16
	Socket 0 CPU Information.....	5-17
	CPU Power Management Configuration	5-18
5.4.7	Advanced - F81846 Super IO Configuration	5-19
	F81846 Super IO Configuration - Serial Port 1 Configuration.....	5-20
	F81846 Super IO Configuration - Serial Port 2 Configuration.....	5-21
	F81846 Super IO Configuration - Serial Port 3 Configuration.....	5-22
	F81846 Super IO Configuration - Serial Port 4 Configuration.....	5-23
5.4.8	Advanced – USB Configuration.....	5-24
5.4.9	Advanced – Platform Trust Technology.....	5-25
5.5	Chipset	5-26

5.5.1	Chipset - North Bridge	5-27
5.5.2	Chipset - South Bridge	5-28
	South Bridge - HD-Audio Configuration	5-29
	South Bridge - LPSS Configuration	5-30
	South Bridge - PCI Express Configuration	5-31
	South Bridge - SATA Drives.....	5-35
	South Bridge - Miscellaneous Configuration	5-36
5.6	Security	5-37
5.7	Boot	5-39
5.8	Save & Exit.....	5-41
Appendix A System Diagrams		A-1
	BS-E098 System Exploded Diagram	A-2
	BS-E098 SATA HDD Exploded Diagram.....	A-4
Appendix B Technical Summary		B-1
	Interrupt Map	B-2
	I/O MAP	B-13
	Memory Map.....	B-14
	Configuring WatchDog Timer	B-16
	Flash BIOS Update.....	B-18

Revision History

The revision history of BS-E098 User Manual is described below:

Version No.	Revision History	Date
M1	Initial Release	2017/03/17
M2	<ul style="list-style-type: none">• The Chapter 5 BIOS Setup has been modified.• The Appendix B Technical Summary has been modified.	2017/07

1 Introduction

This chapter provides the introduction for BS-E098 system as well as the framework of the user manual.

The following topic is included:

- About This Manual

1.1 About This Manual

Thank you for purchasing our BS-E098 system. The BS-E098 provides faster processing speed, greater expandability and can handle more tasks than before. This manual is designed to assist you how to install and set up the whole system. It contains 5 chapters and 2 appendixes. Users can configure the system according to their own needs. This user manual is intended for service personnel with strong hardware background. It is not intended for general users.

The following section outlines the structure of this user manual.

Chapter 1 Introduction

This chapter provides the introduction for the BS-E098 system as well as the framework of the user manual.

Chapter 2 Getting Started

This chapter describes the package contents and outlines the system specifications. Read the safety reminders carefully on how to take care of your system properly.

Chapter 3 System Configuration

This chapter describes the external I/O ports, outlines the locations of the motherboard components and their respective functions. You will learn how to set the jumpers and configure the system to meet your own needs.

Chapter 4 Software Utilities

This chapter contains helpful information for proper installations of the Intel Chipset Software Installation Utility, Graphics Driver Utility, LAN Driver Utility, Sound Driver Utility, Serial I/O Driver Utility and Microsoft Hotfix kb3211320 and kb3213986 Driver Utility.

Chapter 5 BIOS Setup

This chapter indicates you how to change the BIOS configurations.

Appendix A System Diagrams

This appendix provides exploded diagrams and part numbers of BS-E098 system.

Appendix B Technical Summary

This appendix provides the information about the allocation maps for the system resources, Watchdog Timer Configuration and Flash BIOS Update.

2 Getting Started

This chapter provides the information for the BS-E098 system. It describes the package contents and outlines the system specifications.

The following topics are included:

- Package List
- System Overview
- System Diagrams
- System Specification
- Safety Precautions

Experienced users can go to Chapter 3 System Configuration on page 3-1 for a quick start.

2.1 Packing List

If you discover any of the items listed below are damaged or lost, please contact your local distributor immediately.

Item	Q'ty
BS-E098	1
Quick Reference Guide	1
Manual / Driver DVD	1
Mini Jumper (2.0 mm)	6

2.2 System Overview

Unit: mm

2.2.1 Front View

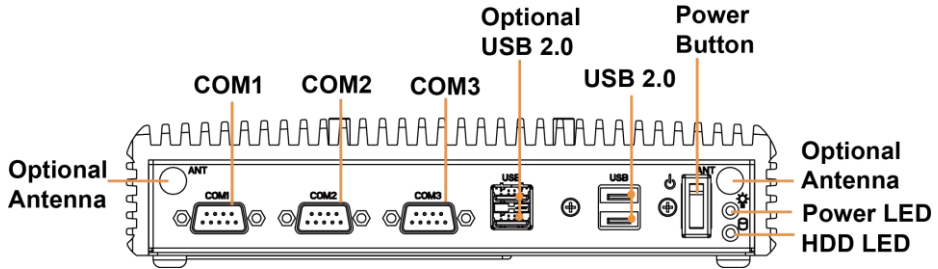

2.2.2 Rear View

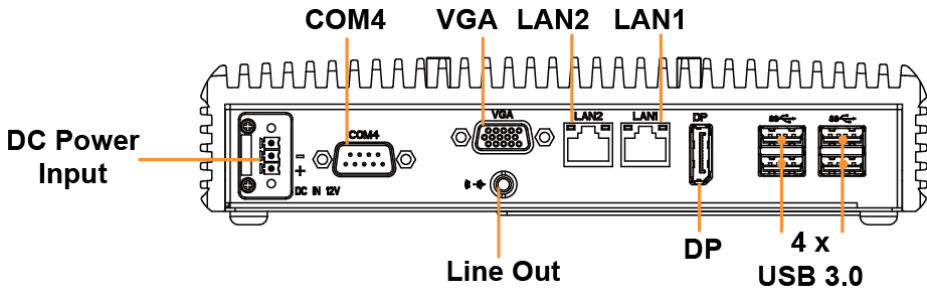

2.2.3 Top View

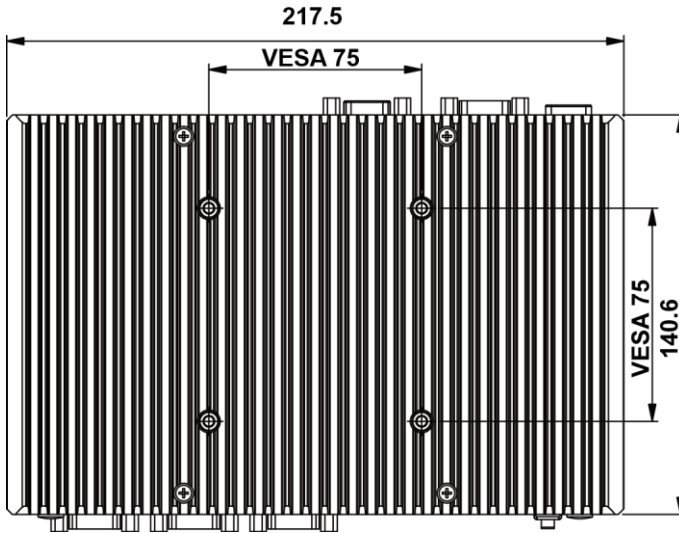

2.2.4 Side View

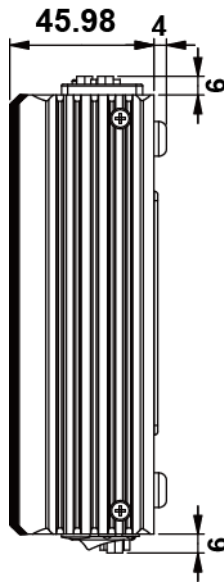

2.2.5 Bottom View

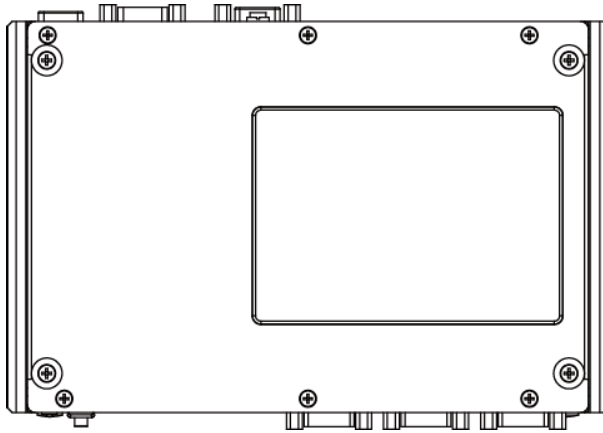

2.2.6 Quarter View

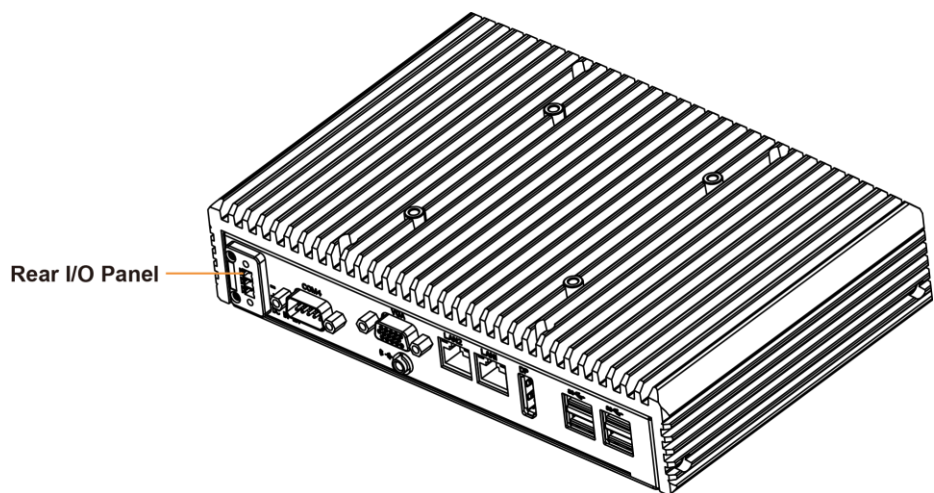
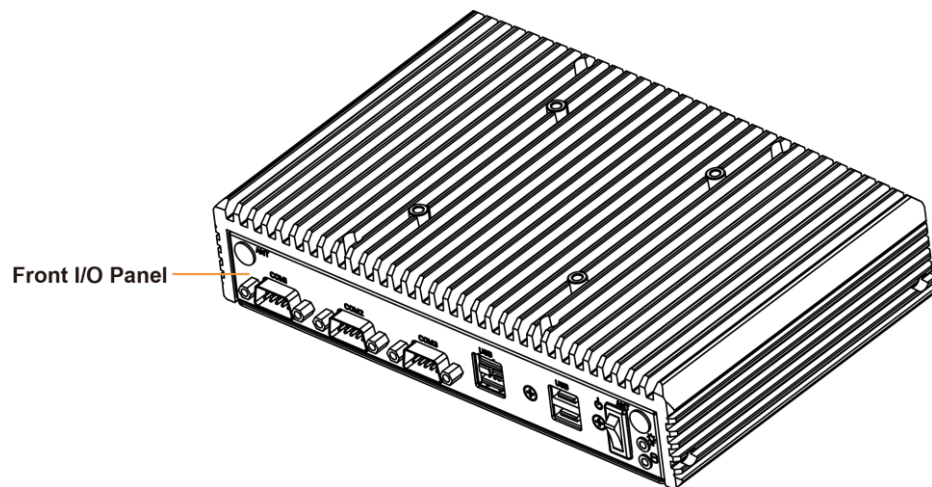

2.3 System Specifications

System	
CPU	<ul style="list-style-type: none"> ➤ BS-E098RA-N1B: Pentium N4200 4C/6W/2.5GHz ➤ BS-E098RA-N0B: Celeron N3350 2C/6W/2.4GHz ➤ BS-E098RA-U1B: Pentium N4200 4C/6W/2.5GHz ➤ BS-E098RA-U0B: Celeron N3350 2C/6W/2.4GHz
Memory Support	➤ 1x SO-DIMM 1600/1867 DDR3L DRAM socket (up to 8 GB) (non-ECC)
Storage Support	➤ Supports 1 x 2.5" 7mm SATAIII HDD / SSD
Power Supply	➤ Supports only DC 12V power input (3-pin lockable terminal block)
O.S. Support	<ul style="list-style-type: none"> ➤ Windows® 10 64bit ➤ Ubuntu14.04 64bit (kernel 4.4)
BIOS	➤ AMI UEFI BIOS
Dimensions (W x H x D)	➤ 217.5 x 45 x 148mm
Weight	➤ 2kg
I/O Ports	
USB	<ul style="list-style-type: none"> ➤ BS-E098RA-N1B and BS-E098RA-N0B: 4 x USB 3.0 on rear I/O, 2 x USB 2.0 on front I/O (6 x USB ports) ➤ BS-E098RA-U1B and BS-E098RA-U0B: 4 x USB 3.0 on rear I/O, 4 x USB 2.0 on front I/O (8 x USB ports)
Serial Ports	<ul style="list-style-type: none"> ➤ COM1~COM3 on front I/O ➤ COM4 on rear I/O ➤ COM2 supports RS-232/422/485 (default: RS-232, selectable under BIOS) ➤ RS-485 supports auto flow control (default: non-auto, selectable under BIOS) ➤ COM3/4 pin9 supports RI/5V/12V(default:RI, selectable by jumper)
Antenna Holes	➤ 2 x antenna holes for reservation
LAN	➤ 2 x Gigabit LAN (on rear I/O panel), supports Wake-on-LAN
Expansion Slots / mSATA	<ul style="list-style-type: none"> ➤ BS-E098RA-N1B and BS-E098RA-N0B: 1 x full-sized mPCIe, 1 x full-sized mSATA (with USB signals) ➤ BS-E098RA-U1B and BS-E098RA-U0B: 1 x full-sized mSATA (with USB signals)

Display	
Display	<ul style="list-style-type: none"> ➤ 1 x DP1.2 resolution: up to 4096x2160@60Hz (on rear I/O Panel) ➤ 1 x VGA resolution: up to 1920x1200@60Hz (on rear I/O Panel)
Power Mode	
ATX Power Mode	<ul style="list-style-type: none"> ➤ (1) Auto boot-up when AC power is restored for the first time (default setting) ➤ (2) Non-auto boot-up whenever AC power is restored (selectable under BIOS) ➤ Way to boot up from S5: (1) Power Button (2) Wake-On-LAN (3) mPCIe-wake (4) RTC-wake ➤ Way to Shutdown to S5/S4/S3: (1) Power Button (2) OS Command ➤ Supports S0/S3/S4/S5
Others	
Sound	➤ 1 x Line Out (on rear I/O panel)
Software Support	<ul style="list-style-type: none"> ➤ Hardware Monitor API (for Temp) ➤ WatchDog API
Optional Accessory	➤ 60W Power adapter with lockable 3-pin terminal block
Environment	
EMC & Safety	➤ CE / FCC
Operating Temp.	<ul style="list-style-type: none"> ➤ SSD: 0°C ~60°C (32°F~140°F) ➤ HDD: 0°C ~40°C (32°F~104°F)
Storage Temp.	➤ -40°C ~85°C (-40°F~185°F)
Humidity	➤ 20%~ 95%

2.4 Safety Precautions

Before operating this system, read the following information carefully to protect your systems from damages, and extend the life cycle of the system.

1. Check the Line Voltage
 - The operating voltage for the power supply should be within the range of 100V to 240V AC; otherwise, the system may be damaged.
2. Environmental Conditions
 - Place your BS-E098 on a sturdy, level surface. Be sure to allow enough space around the system to have easy access needs.
 - Avoid installing your BS-E098 system in extremely hot or cold places.
 - Avoid direct sunlight exposure for a long period of time (for example, in a closed car in summer time. Also avoid the system from any heating device.). Or do not use BS-E098 when it has been left outdoors in a cold winter day.
 - Avoid moving the system rapidly from a hot place to a cold place, and vice versa, because condensation may occur inside the system.
 - Protect your BS-E098 from strong vibrations which may cause hard disk failure.
 - Do not place the system too close to any radio-active device. Radio-active device may cause signal interference.
 - Always shut down the operating system before turning off the power.
3. Handling
 - Avoid placing heavy objects on the top of the system.
 - Do not turn the system upside down. This may cause the hard drive to malfunction.
 - Do not allow any objects to fall into this device.
 - If water or other liquid spills into the device, unplug the power cord immediately.
4. Good Care
 - When the outside case gets stained, remove the stains using neutral washing agent with a dry cloth.
 - Never use strong agents such as benzene and thinner to clean the surface of the case.
 - If heavy stains are present, moisten a cloth with diluted neutral washing agent or alcohol and then wipe thoroughly with a dry cloth.
 - If dust is accumulated on the case surface, remove it by using a special vacuum cleaner for computers.

3 System Configuration

This chapter contains helpful information about the external I/O Ports diagrams, and jumper & connector settings, and component locations for the main board.

The following topics are included:

- External I/O Ports Diagrams
- Main Board Jumper Settings and Component Locations
- How to Set Jumpers
- Setting Main Board Connectors and Jumpers

3.1 External System I/O Ports Diagrams

3.1.1 Front I/O Ports Diagram

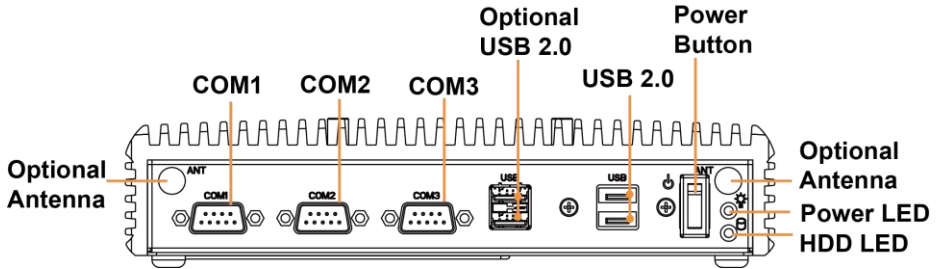

3.1.2 Rear I/O Ports Diagram

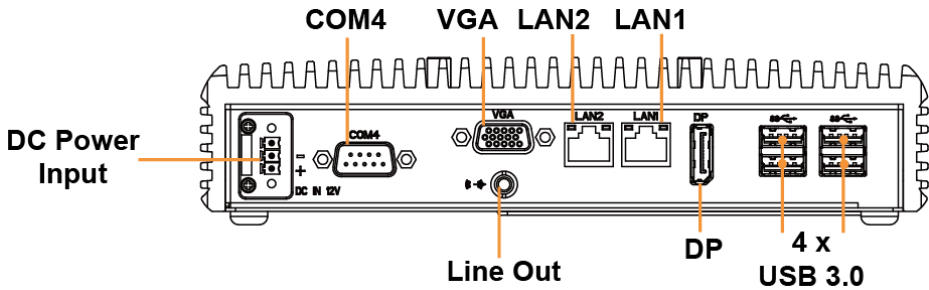

3.2 JUMPER & CONNECTOR QUICK REFERENCE TABLE

JUMPER Description	NAME
COM3 Pin9 RI/5V/12V Selection	JP_COM3
COM4 Pin9 RI/5V/12V Selection	JP_COM4
LVDS VCC Voltage Selection	JP_VDD1
Clear CMOS Data Selection	JP4
LVDS Backlight Control Selection	JP7

System CONNECTOR Description	NAME
COM Connector (Front)	COM1, COM2, COM3
COM Connector (Rear)	COM4
DC IN 3 Pins lockable connector (Rear)	DC IN 12V
VGA Connector (Rear)	VGA
Display Port Connector (Rear)	DP
2 x LAN Ports (Rear)	LAN1, LAN2
2 x Dual USB 3.0 Ports (Rear)	USB3.0
Dual USB 2.0 Ports (Front)	USB2.0
Optional Dual USB 2.0 Ports (Front)	USB2.0
Line Out Connector (Rear)	Line Out

Onboard CONNECTOR Description	NAME
Programmable Digital I/O Pin Header	JDIO1
I2C Wafer	JI2C1
System Fan Connector	FAN1
DC Power Input Connector	PWR2

Onboard CONNECTOR Description	NAME
Mini PCI Express Slot	M_PCIE1
mSATA Connector	SLOT1
LVDS Connector	LVDS1
Front Panel Connector	JFP1
HD Audio Connector	AUDIO1
Panel Inverter Connector	JINV1
SATA 3.0 Connector	SATA1
SATA Power Connector	SATA_PWR1
BIOS Reset Connector	JP9

3.3 COMPONENT LOCATIONS OF SYSTEM MAIN BOARD

3.3.1 Top View of System Main Board (BE-0981RA-**N)

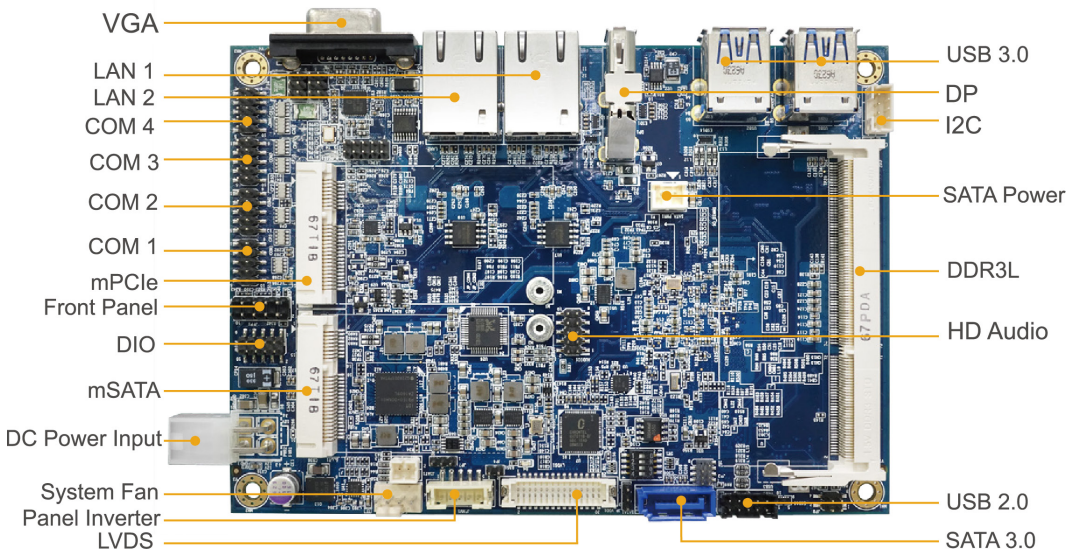



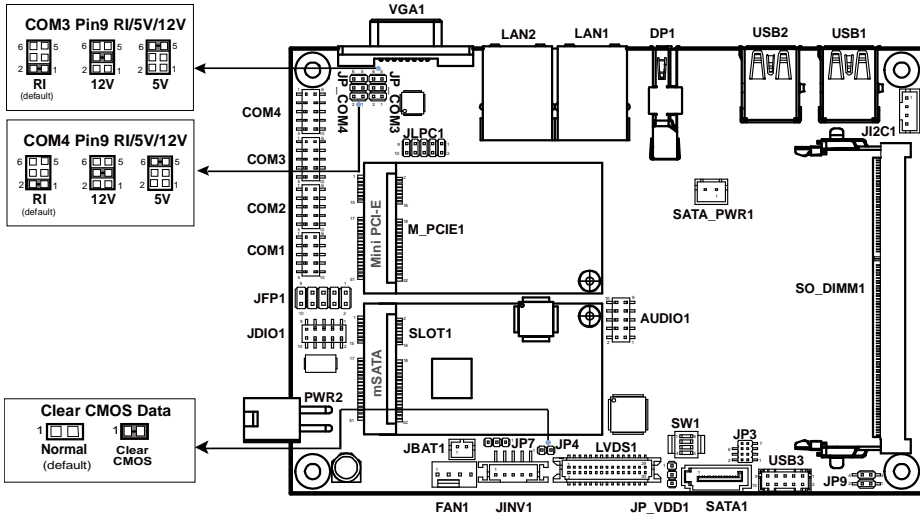

Figure 3-1. Main Board Component Location (Top View)

	<p>WARNING: Always disconnect the power cord when you are working with connectors and jumpers on the main board. Make sure both the system and peripheral devices are turned OFF as sudden surge of power could damage sensitive components. Make sure BS-E098 is properly grounded.</p>
	<p>CAUTION: Observe precautions while handling electrostatic sensitive components. Make sure to ground yourself to prevent static charge while you are working on the connectors and jumpers. Use a grounding wrist strap and place all electronic components in any static-shielded devices.</p>
	<p>CAUTION: Always touch the motherboard components by the edges. Never touch components such as a processor by its pins. Take special cares while you are holding electronic circuit boards by the edges only. Do not touch the main board components.</p>

3.3.2 Jumper Setting of System Main Board (BE-0981RA-**N)



**3.3.3 Bottom View of System Main Board (BE-0981RA-N0N/
BE-0981RA-N1N)**

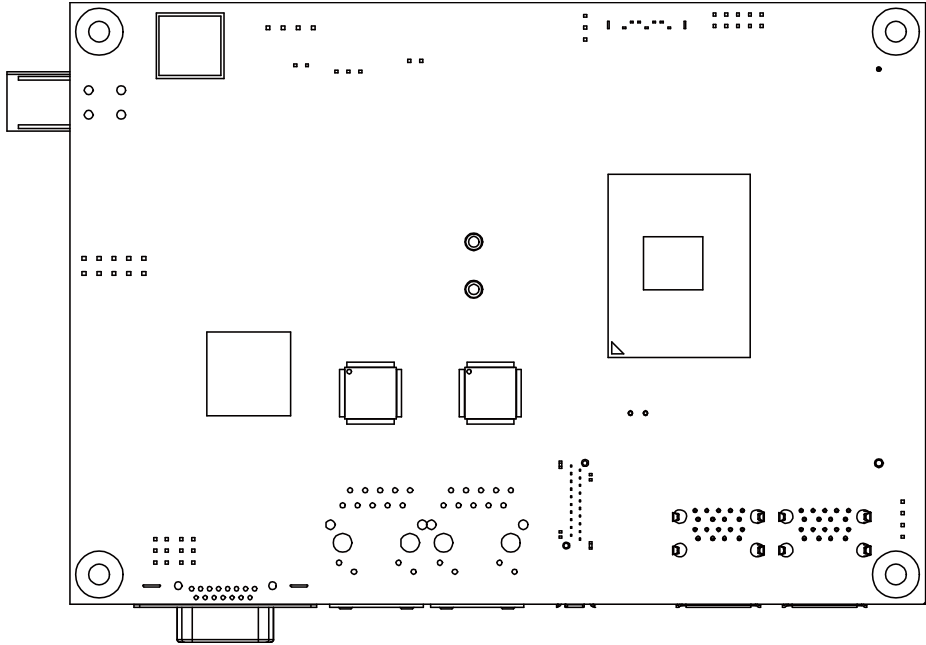

3.3.4 HOW TO SET JUMPERS

You can configure your board by setting jumpers. Jumper is consists of two or three metal pins with a plastic base mounted on the card, and by using a small plastic "cap", Also known as the jumper cap (with a metal contact inside), you are able to connect the pins. So you can set-up your hardware configuration by "open" or "close" pins.

The jumper can be combined into sets that called jumper blocks. When the jumpers are all in the block, you have to put them together to set up the hardware configuration. The figure below shows how this looks like.

JUMPERS AND CAPS

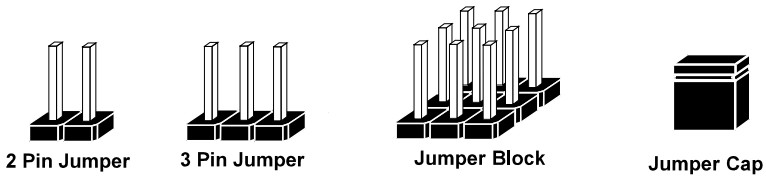

If a jumper has three pins (for examples, labelled PIN1, PIN2, and PIN3), you can connect PIN1 & PIN2 to create one setting by shorting. You can either connect PIN2 & PIN3 to create another setting. The same jumper diagrams are applied all through this manual. The figure below shows what the manual diagrams look and what they represent.

Jumper Diagrams



Jumper Cap
looks like this

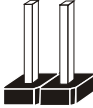

2 pin Jumper
looks like this

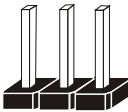

3 pin Jumper
looks like this

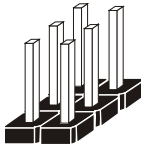

Jumper Block
looks like this

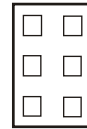

Jumper Settings



2 pin Jumper close(enabled)
Looks like this

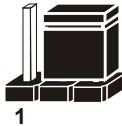

3 pin Jumper
2-3 pin close(enabled)
Looks like this



Jumper Block
1-2 pin close(enabled)
Looks like this

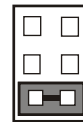

3.4 Setting Connectors and Jumpers

3.4.1 COM3 and COM4 PIN9 Definition Selection Guide

Jumper Location: JP_COM3, JP_COM4

Description: COM3 and COM4 Port pin9 RI/5V/12V Selection

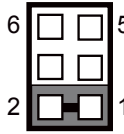
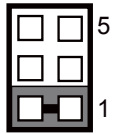
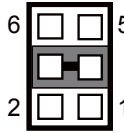
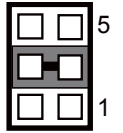
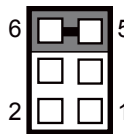
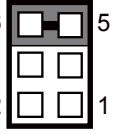
SELECTION	JUMPER SETTING	JUMPER ILLUSTRATION	
RI	1-2 <i>(Default Setting)</i>	 <p>JP_COM3</p>	 <p>JP_COM4</p>
+12V	3-4	 <p>JP_COM3</p>	 <p>JP_COM4</p>
+5V	5-6	 <p>JP_COM3</p>	 <p>JP_COM4</p>

3.4.2 COM PORT

Port Location: COM1 (RS-232)

Description: COM Port Connector

PIN	ASSIGNMENT	PIN	ASSIGNMENT
1	DCD#	6	DSR#
2	RX	7	RTS#
3	TX	8	CTS#
4	DTR#	9	RI#
5	GND	-	-

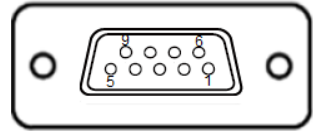

COM1

Port Location: COM2 (RS-232/422/485)

Description: COM Port Connector

PIN	ASSIGNMENT		
	RS-232	RS-422	RS-485
1	DCD#	TX-	RS-485-
2	RX	TX+	RS-485+
3	TX	RX+	X
4	DTR#	RX-	X
5	GND	GND	GND
6	DSR#	X	X
7	RTS#	X	X
8	CTS#	X	X
9	RI#	X	X

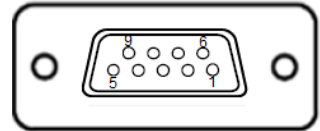

COM2

Notes:

1. COM2 is selectable as RS-232, RS422, RS485 by BIOS setting.
2. Default setting is RS-232. Please see **Chapter 5 “Advanced – Onboard Device Configuration”** for selection details.

Port Location: COM3 (RS-232)

Description: COM Port Connector

PIN	ASSIGNMENT	PIN	ASSIGNMENT
1	DCD#	6	DSR#
2	RX	7	RTS#
3	TX	8	CTS#
4	DTR#	9	RI#
5	GND	-	-

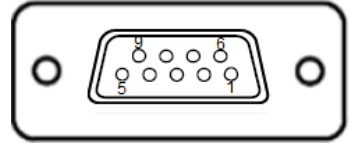

COM3

Port Location: COM4 (RS-232)

Description: COM Port Connector

PIN	ASSIGNMENT	PIN	ASSIGNMENT
1	DCD#	6	DSR#
2	RX	7	RTS#
3	TX	8	CTS#
4	DTR#	9	RI#
5	GND	-	-

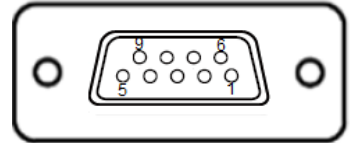

COM4

Note:

COM3, COM4: Pin 9 is selectable for RI, +5V or +12V by jumper setting. Default setting is RI, please see “COM3 and COM4 PIN9 Definition Selection Guide” for selection details.

3.4.3 DC-IN 3-Pin Terminal Block

Port Location: DC-IN

Description: Supports DC 12V power input (3-pin lockable terminal block)

PIN	ASSIGNMENT
1	+12V
2	GND
3	NC

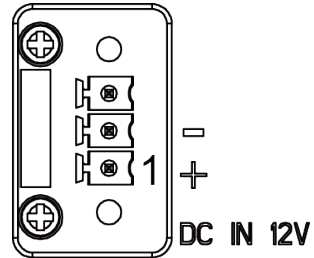

DC-IN

3.4.4 VGA PORT

Port Location: VGA1

Description: VGA Port, D-Sub 15-pin (I/O port)

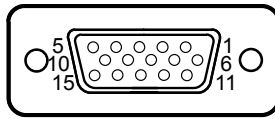

VGA1

PIN	ASSIGNMENT	PIN	ASSIGNMENT	PIN	ASSIGNMENT
1	CRT_RED	6	GND	11	NC
2	CRT_GREEN	7	GND	12	CRT_DATA
3	CRT_BLUE	8	GND	13	CRT_HSYNC
4	NC	9	CRT_VCC	14	CRT_VSYNC
5	GND	10	GND	15	CRT_CLK

3.4.5 DISPLAY PORT

Port Location: DP1

Description: DisplayPort Connector

PIN	ASSIGNMENT	PIN	ASSIGNMENT
1	DP0_TX0_DP	2	GND
3	DP0_TX0_DN	4	DP0_TX1_DP
5	GND	6	DP0_TX1_DN
7	DP0_TX2_DP	8	GND
9	DP0_TX2_DN_C	10	DP0_TX3_DP_C
11	GND	12	DP0_TX3_DN
13	DP0_AUX_ENJ	14	GND
15	DP0_AUX_P_CON	16	GND
17	DP0_AUX_N_CON	18	HPD_CON
19	GND	20	VCC3_PWR

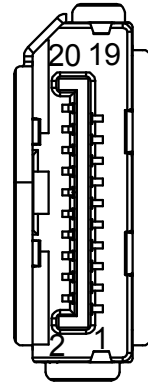

DP1

3.4.6 LAN PORT

Port Location: LAN1, LAN2

Description: LAN RJ45 Port (rear I/O)

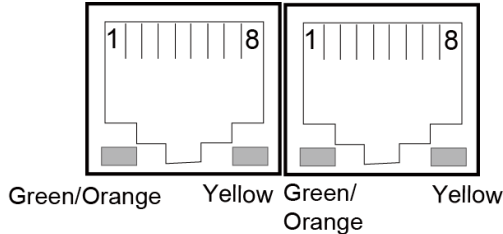

LAN1 / LAN2

LAN1 Pin Assignment

PIN	ASSIGNMENT
1	LAN1_MDIP0
2	LAN1_MDIN0
3	LAN1_MDIP1
4	LAN1_MDIP2
5	LAN1_MDIN2
6	LAN1_MDIN1
7	LAN1_MDIP3
8	LAN1_MDIN3

LAN2 Pin Assignment

PIN	ASSIGNMENT
1	LAN2_MDIP0
2	LAN2_MDIN0
3	LAN2_MDIP1
4	LAN2_MDIP2
5	LAN2_MDIN2
6	LAN2_MDIN1
7	LAN2_MDIP3
8	LAN2_MDIN3

LAN LED Status

There are LAN LED indicators on the rear side of the main board. By observing their status, you can know the status of the Ethernet connection.

LAN LED Indicator	Color	Status	Description
Right Side LED	Yellow	Blink	LAN Message Active
	-	Off	No LAN Message Active
Left Side LED	Green	On	10/100 Mbps LAN connection is enabled.
	Orange	On	Giga LAN connection is enabled.
	-	Off	No LAN switch/hub is connected

3.4.7 DUAL USB 3.0 PORT (USB1)

Port Location: USB1

Description: USB 3.0 port x 2

USB 3.0 signals:

PIN	ASSIGNMENT	PIN	ASSIGNMENT
B5	USB3_RXN2	-	-
B6	USB3_RXP2	B4	GND
B7	GND	B3	USB2_P2_DP
B8	USB3_TXN2	B2	USB2_P2_DN
B9	USB3_TXP2	B1	VCC5_USB1
A5	USB3_RXN1	-	-
A6	USB3_RXP1	A4	GND
A7	GND	A3	USB2_P1_DP
A8	USB3_TXN1	A2	USB2_P1_DN
A9	USB3_TXP1	A1	VCC5_USB1

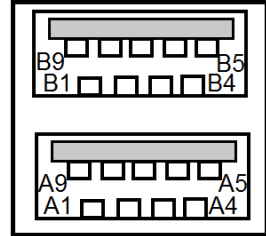

USB1

3.4.8 USB 3.0 PORT (USB2)

Port Location: USB2

Description: USB 3.0 port x 2

USB 3.0 signals:

PIN	ASSIGNMENT	PIN	ASSIGNMENT
B5	USB3_RXN2	-	-
B6	USB3_RXP2	B4	GND
B7	GND	B3	USB2_P2_DP
B8	USB3_TXN2	B2	USB2_P2_DN
B9	USB3_TXP2	B1	VCC5_USB1
A5	USB3_RXN1	-	-
A6	USB3_RXP1	A4	GND
A7	GND	A3	USB2_P1_DP
A8	USB3_TXN1	A2	USB2_P1_DN
A9	USB3_TXP1	A1	VCC5_USB1

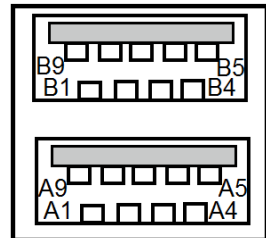

USB2

3.4.9 USB 2.0 PORT (USB3)

Port Location: USB3

Description: Internal USB 2.0 port x 2

USB 2.0 signals:

PIN	ASSIGNMENT	PIN	ASSIGNMENT
1	VCC5_USB3	2	VCC5_USB3
3	USB2_P5_DN	4	USB2_P6_DN
5	USB2_P5_DP	6	USB2_P6_DP
7	GND	8	GND
9	GND	10	GND

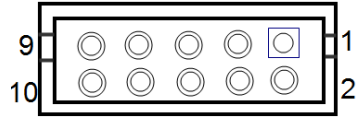

USB3

3.4.10 Programmable DIGITAL I/O PIN HEADER

Connector Location: JDIO1

Description: Digital Input / Output pin header and 5V power

PIN	ASSIGNMENT	PIN	ASSIGNMENT
1	VCC5	2	GND
3	DIN/DOUT 0	4	DIN/DOUT 4
5	DIN/DOUT 1	6	DIN/DOUT 5
7	DIN/DOUT 2	8	DIN/DOUT 6
9	DIN/DOUT 3	10	DIN/DOUT 7

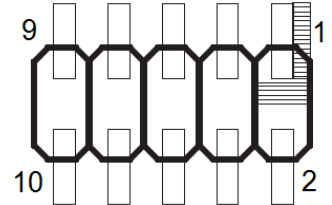

JDIO1

Notes:

1. Users can set the DIN/DOUT configuration via Protech’s API/Utility.
2. Default setting is set as DIN every time when the system boots up.

3.4.11 I2C WAFER

Connector Location: JI2C1

Description: I2C Wafer

PIN	ASSIGNMENT
1	GND
2	VCC5
3	I2C0_SCL_33
4	I2C0_SDA_33

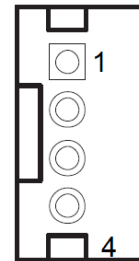

JI2C1

3.4.12 SYSTEM FAN CONNECTOR

Connector Location: FAN1

Description: System Fan Connector

PIN	ASSIGNMENT
1	GND
2	VCC12
3	SYSFANIN
4	SYSFANOUT

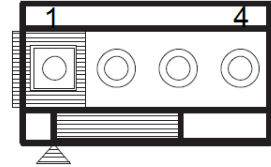

FAN1

Notes:

1. Fan speed mode can be set by BIOS or API.
2. Default BIOS setting is “Auto Duty-Cycle Mode”. Please see Chapter 5 or check API document for more details.

3.4.13 DC POWER INPUT CONNECTOR

Connector Location: PWR2

Description: DC Power Input Connector

PIN	ASSIGNMENT	PIN	ASSIGNMENT
3	VCC12	4	VCC12
2	GND	1	GND



PWR2

3.4.14 MINI PCI EXPRESS SLOT

Connector Location: M_PCIE1

Description: Mini-PCI Express Slot

PIN	ASSIGNMENT	PIN	ASSIGNMENT
1	PCIE_WAKEJ	2	V3P3S
3	Reserved	4	GND
5	Reserved	6	VCC1_5
7	M_CLKREQJ	8	Reserved
9	GND	10	Reserved
11	M_PCIE_CLKN	12	Reserved
13	M_PCIE_CLKP	14	Reserved
15	GND	16	Reserved
17	Reserved	18	GND
19	Reserved	20	Reserved
21	GND	22	PMU_PLTRST_N
23	PCIE_P2_RXN	24	V3_3SB
25	PCIE_P2_RXP	26	GND
27	GND	28	VCC1_5
29	GND	30	SMB_3P3_SCL
31	PCIE_P2_TXN	32	SMB_3P3_SDA
33	PCIE_P2_TXP	34	GND
35	GND	36	USB2_P7_DN
37	GND	38	USB2_P7_DP
39	V3P3S	40	GND
41	V3P3S	42	NC
43	GND	44	NC
45	NC	46	NC
47	NC	48	VCC1_5
49	NC	50	GND
51	NC	52	V3P3S

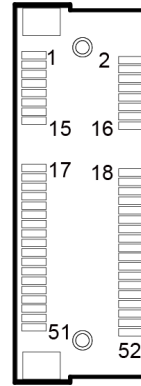

M_PCIE1

Mini PCI Express is the successor of the Mini PCI card and provides an increased data throughput. The cards have a detached network interface and are equipped with one lane. They are used in particular in embedded designs or compact box PCs.

3.4.15 mSATA Connector

Connector Location: **SLOT1**

Description: mSATA Slot (USB type mPCIe card is supported.)

PIN	ASSIGNMENT	PIN	ASSIGNMENT
1	NC	2	V3P3S_MSATA
3	NC	4	GND
5	NC	6	NC
7	NC	8	NC
9	GND	10	NC
11	NC	12	NC
13	NC	14	NC
15	GND	16	NC
17	NC	18	GND
19	NC	20	NC
21	GND	22	NC
23	SATA_RXP1	24	V3P3S_MSATA
25	SATA_RXN1	26	GND
27	GND	28	NC
29	GND	30	NC
31	SATA_TXN1	32	NC
33	SATA_TXP1	34	GND
35	GND	36	USB2_P0_DN
37	GND	38	USB2_P0_DP
39	V3P3S_MSATA	40	GND
41	V3P3S_MSATA	42	NC
43	NC	44	NC
45	NC	46	NC
47	NC	48	NC
49	NC	50	GND
51	NC	52	V3P3S_MSATA

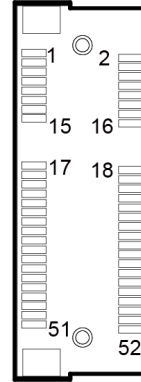

SLOT1

3.4.16 LVDS CONNECTOR

Connector Location: LVDS1

Description: LVDS Connector

PIN	ASSIGNMENT	PIN	ASSIGNMENT
2	GND	1	LVDS_VCC
4	LVDS_CLKB_DP	3	LVDS_CLKB_DN
6	LVDS_B2_DN	5	GND
8	GND	7	LVDS_B2_DP
10	LVDS_B1_DP	9	LVDS_B1_DN
12	LVDS_B3_DN	11	LVDS_B3_DP
14	LVDS_B0_DN	13	LVDS_B0_DP
16	LVDS_CLKA_DP	15	GND
18	GND	17	LVDS_CLKA_DN
20	LVDS_A2_DN	19	LVDS_A2_DP
22	LVDS_A1_DP	21	GND
24	GND	23	LVDS_A1_DN
26	LVDS_A0_DN	25	LVDS_A0_DP
28	LVDS_A3_DN	27	LVDS_A3_DP
30	LVDS_VCC	29	LVDS_VCC

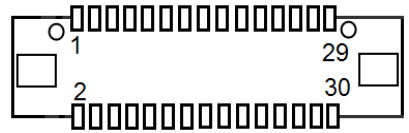

LVDS1

3.4.17 FRONT PANEL CONNECTOR

Connector Location: JFP1

Description: Front Panel Connector

PIN	ASSIGNMENT	PIN	ASSIGNMENT
1	HDD LED+	2	POWER LED+
3	HDD LED-	4	NC
5	GND	6	GND
7	RESET BTN	8	GND
9	NC	10	POWER BTN

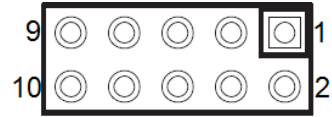

JFP1

3.4.18 HD AUDIO CONNECTOR

Connector Location: AUDIO1

Description: HD Audio Connector for Line In / Line Out / Mic In.

PIN	ASSIGNMENT	PIN	ASSIGNMENT
1	HD_MIC1-L	2	HD_MIC1-R
3	HD_GND	4	HD_GND
5	HD_LINE-IN-L	6	HD_LINE-IN-R
7	HD_GND	8	HD_GND
9	LINE-OUT-L	10	LINE-OUT-L

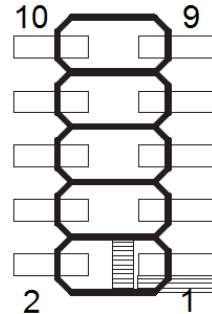

AUDIO1

3.4.19 PANEL INVERTER CONNECTOR

Connector Location: JINV1

Description: Panel Inverter Connector

PIN	ASSIGNMENT
1	VCC12
2	VCC12
3	GND
4	LVDS_BKLCTL
5	LVDS_BKLTEN

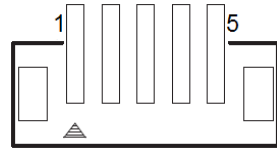

JINV1

3.4.20 SATA 3.0 CONNECTOR

Connector Location: SATA1

Description: Serial ATA 3.0 Connector

PIN	ASSIGNMENT
1	GND
2	SATA_TXP0
3	SATA_TXN0
4	GND
5	SATA_RXN0
6	SATA_RXP0
7	GND

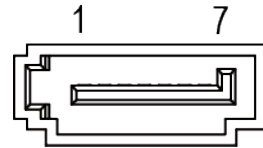

SATA1

3.4.21 SATA POWER CONNECTOR

Connector Location: SATA_PWR1

Description: Serial ATA Power Connector

PIN	ASSIGNMENT
1	VCC5
2	GND

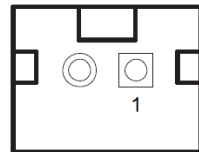

SATA_PWR1

3.4.22 BIOS RESET CONNECTOR

Jumper Location: JP9



Description: BIOS Reset Usage Connector

This connector is only for Protech's engineers. (Purpose: BIOS reset). Please do not use this connector; otherwise, the system might be crashed.

3.4.23 LVDS BACKLIGHT CONTROL SELECTION

Jumper Location: JP7

Description: Jumper for selecting PIN5 (LVDS_BKLTEN) voltage of JINV1.

SELECTION	JUMPER SETTING	JUMPER ILLUSTRATION
3.3V	1-2 <i>(Default Setting)</i>	 JP7
5V	2-3	 JP7



Note 1: Users can change the setting according to panel specification

Note 2: Please refer to **PANEL INVERTER CONNECTOR** for more details about pin definition of JINV1.

3.4.24 LVDS VCC VOLTAGE SELECTION

Jumper Location: JP_VDD1

Description: Voltage selection jumper for selecting PIN1, PIN29, PIN30 (LVDS_VCC) voltage of LVDS1.

SELECTION	JUMPTER SETTING	JUMPER ILLUSTRATION
3.3V	1-2 <i>(Default Setting)</i>	 <p>JP_VDD1</p>
5V	2-3	 <p>JP_VDD1</p>



Note: Please refer to **PANEL INVERTER CONNECTOR** for more information about pin definition of JINV1.

3.4.25 CLEAR CMOS DATA SELECTION

Jumper Location: JP4

Description: Clear CMOS Data Selection

- Step1.** Remove the main power of the PC.
- Step2.** Close JP4 (pins 1-2) for 6 seconds by a cap.
- Step3.** Remove the cap which is just used on JP4 (1-2), so that JP4 returns to “OPEN”.
- Step4.** Power on the PC and the PC will then auto-reboot for once in order to set SoC’s register.
- Step5.** Done!

SELECTION	JUMPER SETTING	JUMPER ILLUSTRATION
Normal	Open <i>(Default Setting)</i>	 JP4
Clear CMOS	1-2	 JP4

4 Software Utilities

This chapter provides the detailed information that guides users to install driver utilities for the system. The following topics are included:

- Installing Intel[®] Chipset Software Installation Utility
- Installing Graphics Driver Utility
- Installing LAN Driver Utility
- Installing Sound Driver Utility
- Installing Serial I/O Driver Utility
- Installing Microsoft Hotfix kb3211320 and kb3213986 Driver Utility

4.1 Introduction

Enclosed with the BS-E098 Series package is our driver utilities contained in a DVD-ROM disk. Refer to the following table for driver locations:

Filename (Assume that DVD-ROM drive is D:)	Purpose	Shell	Win10 64-bit OS
D:\Driver\Flash BIOS	For Aptio(EFI) BIOS update utility	✓	X
D:\Driver\Platform\Main Chip	Intel(R) Chipset Device Software Installation Utility	X	✓
D:\Driver\Platform\TXE	For Intel Trusted Execution Engine Interface	X	✓
D:\Driver\Platform\Graphics	Intel HD Graphics	X	✓
D:\Driver\Platform\LAN Chip	Intel I210 For LAN Driver installation	X	✓
D:\Driver\Platform\Sound Codec	Realtek ALC888 For Sound driver installation	X	✓
D:\Driver\Platform\Serial IO	Intel® Serial I/O Driver installation	X	✓
D:\Driver\Platform\Hotfix	Microsoft Hotfix kb3211320 and kb3213986 for Windows10 64-bit critical security update	X	✓

X : Not supported

✓ : Supported

Note: Install the driver utilities immediately after the OS installation is completed.

4.2 Installing Intel® Chipset Software Installation Utility

Introduction

The Intel® Chipset Software Installation Utility installs the Windows *.INF files to the target system. These files outline to the operating system how to configure the Intel chipset components in order to ensure that the following functions work properly:

- Core PCI and ISAPNP Services
- PCIe Support
- SATA Storage Support
- USB Support
- Identification of Intel® Chipset Components in the Device Manager

Intel® Chipset Software Installation Utility

The utility pack is to be installed only for Windows 10 64bit, and it should be installed immediately after the OS installation is finished. Please follow the steps below:

- 1** Connect the USB DVD-ROM device to BS-E098 and insert the driver disk.
- 2** Enter the **Main Chip** folder where the Chipset driver is located (depending on your OS platform).
- 3** Click **SetupChipset.exe** file for driver installation.
- 4** Follow the on-screen instructions to install the driver.
- 5** Once the installation is completed, shut down the system and restart BS-E098 for the changes to take effect.

4.3 Installing Graphics Driver Utility

The Graphics interface embedded in BS-E098 can support a wide range of display types. You can have dual displays via LVDS interfaces and make the system work simultaneously.

To install the Graphics driver utility, follow the steps below:

- 1** Connect the USB DVD-ROM device to BS-E098 and insert the driver disk.
- 2** Enter the **Graphics** folder where the driver is located (depending on your OS platform).
- 3** Click the **Setup.exe** file for driver installation.
- 4** Follow the on-screen instructions to complete the installation.
- 5** Once the installation is completed, shut down the system and restart BS-E098 for the changes to take effect.

4.4 Installing LAN Driver Utility

Enhanced with LAN function, BS-E098 supports various network adapters. To install the LAN Driver, follow the steps below:

- 1** Connect the USB DVD-ROM device to BS-E098 and insert the driver disk.
- 2** Enter the **LAN Chip** folder where the driver is located (depending on your OS platform).
- 3** Click the LAN driver file for driver installation.
- 4** Follow the on-screen instructions to complete the installation.
- 5** Once the installation is completed, shut down the system and restart BS-E098 for the changes to take effect.

For more details on the installation procedure, refer to the Readme.txt file that you can find on LAN Driver Utility.

4.5 Installing Sound Driver Utility

The sound function enhanced in this system is fully compatible with Windows 10 64bit.

To install the Sound Driver, follow the steps below:

- 1** Connect the USB DVD-ROM device to BS-E098 and insert the driver disk.
- 2** Open the **Sound Codec** folder where the driver is located (depending on your OS platform).
- 3** Click the Sound driver file for driver installation.
- 4** Follow the on-screen instructions to complete the installation.
- 5** Once the installation is completed, shut down the system and restart BS-E098 for the changes to take effect.

4.6 Installing Intel® Serial I/O Driver Utility

To install the Serial I/O Driver, follow the steps below:

- 1** Connect the USB DVD-ROM device to BS-E098 and insert the driver disk.
- 2** Open the **Serial I/O** folder where the driver is located.
- 3** Select Windows 10 (64-bit) folder for your OS platform.
- 4** Click the **SetupSerialIO.exe** file for driver installation.
- 5** Follow the on-screen instructions to complete the installation.
- 6** Once the installation is completed, shut down the system and restart BS-E098 for the changes to take effect.

4.6.1 Installing Microsoft Hotfix kb3211320 and kb3213986 Driver Utility

The Microsoft Hotfix driver utility can only be installed on a Windows 10 (64-bit) platform.

- 1** Connect the USB DVD-ROM device to BS-E098 and insert the driver disk.
- 2** Enter the **Hotfix** folder where the driver is located.
- 3** Click the **windows10.0-kb3211320-x64** and **windows10.0-kb3213986-x64** files for critical security update.
- 4** Follow the on-screen instructions to complete the installation.
- 5** Once the installation is completed, shut down the system and restart BS-E098 for the changes to take effect.

5 BIOS SETUP

This chapter guides users how to configure the basic system configurations via the BIOS Setup Utilities. The information of the system configuration is saved in battery-backed CMOS RAM and BIOS NVRAM so that the Setup information is retained when the system is powered off. The BIOS Setup Utilities consist of the following menu items:

- Accessing Setup Utilities
- Main Menu
- Advanced Menu
- Chipset Menu
- Security Menu
- Boot Menu
- Save & Exit Menu

5.1 Introduction

The BS-E098 System uses an AMI (American Megatrends Incorporated) Aptio BIOS that is stored in the Serial Peripheral Interface Flash Memory (SPI Flash) and can be updated. The SPI Flash contains the built-in BIOS setup program, Power-On Self-Test (POST), PCI auto-configuration utility, LAN EEPROM information, and Plug and Play support.

Aptio is AMI's BIOS firmware based on the UEFI (Unified Extensible Firmware Interface) specifications and the Intel Platform Innovation Framework for EFI. The UEFI specification defines an interface between the operating system and platform firmware. The interface consists of data tables that contain platform-related information, boot service calls, and runtime service calls that are available to the operating system and its loader. These elements have combined to provide a standard environment for booting the operating system and running pre-boot applications.

The diagram below shows the Extensible Firmware Interface's location in the software stack.

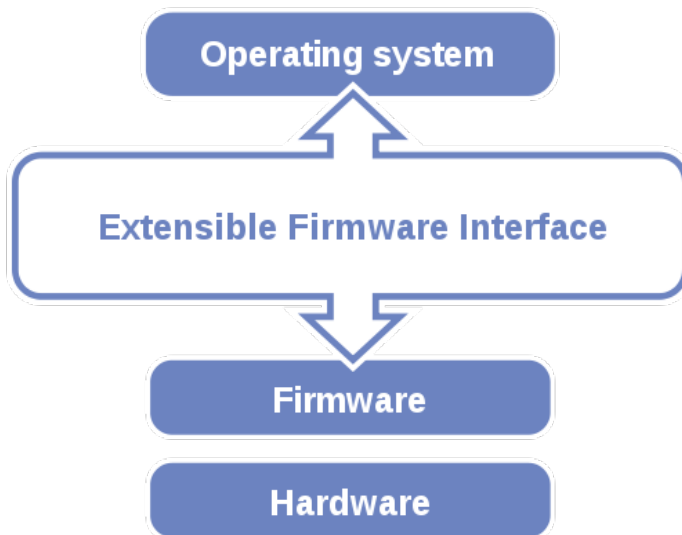

Figure 5-1. Extensible Firmware Interface Diagram

EFI BIOS provides an user interface that allows you to modify hardware configuration, e.g. change the system date and time, enable/disable a system component, determine bootable device priority, set up personal password, etc., which is convenient for engineers to perform modifications and customize the computer

system and allows technicians to troubleshoot the occurred errors when the hardware is faulty.

The BIOS setup menu allows users to view and modify the BIOS settings for the computer. After the system is powered on, users can access the BIOS setup menu by pressing or <Esc> immediately while the POST message is running before the operating system is loading.

Users will need to set up the system configuration from the BIOS Setup Utility when any of the following conditions occurs:

1. You are starting your system for the first time.
2. You have changed the hardware in your system or the hardware becomes faulty.
3. The system configuration is reset after the user configures to clear CMOS data via the JP4 jumper.
4. The power of the CMOS RAM became lost and the system configuration has been erased.

All the menu settings are described in details in this chapter.

5.2 Accessing Setup Utility

After the system is powered on, BIOS will enter the Power-On Self-Test (POST) routines and the POST message will be displayed:



Figure 5-2. POST Screen with AMI Logo

Press or <Esc> to access the Setup Utility program and the **Main** menu of the Aptio Setup Utility will appear on the screen as below:



BIOS Setup Menu Initialization Screen

You may move the cursor by <↑> and <↓> keys to highlight the individual menu items. As you highlight each item, a brief description of the highlighted selection will appear on the right side of the screen.

The language of the BIOS setup menu interface and help messages are shown in US English. You may use <↑> or <↓> key to select among the items and press <Enter> to confirm and enter the sub-menu. The following table provides the list of the navigation keys that you can use while operating the BIOS setup menu.

BIOS Setup Navigation Key	Description
<←> and <→>	Select a different menu screen (move the cursor from the selected menu to the left or right).
<↑> and <↓>	Select a different item (move the cursor from the selected item upwards or downwards)
<Enter>	Execute the command or select the sub-menu.
<F2>	Load the previous configuration values.
<F3>	Load the default configuration values.
<F4>	Save the current values and exit the BIOS setup menu.
<Esc>	Close the sub-menu. Trigger the confirmation to exit BIOS setup menu.

BIOS Messages

This section describes the alert messages generated by the board's BIOS. These messages would be shown on the monitor when certain recoverable errors/events occur during the POST stage. The table bellow gives an explanation of the BIOS alert messages:

BIOS Message	Explanation
A first boot or NVRAM reset condition has been detected.	BIOS has been updated or the battery was replaced.
The CMOS defaults were loaded.	Default values have been loaded after the BIOS was updated or the battery was replaced.
The CMOS battery is bad or has been recently replaced.	The battery may be losing power and users should replace the battery immediately. Also, this message is displayed once the new battery is replaced.

5.3 Main

Menu Path *Main*

The **Main** menu allows you to view the BIOS Information, change the system date and time, and view the user access privilege level. Use tab to switch between date elements. Use <↑> or <↓> arrow keys to highlight the item and enter the value you want in each item. This screen also displays the BIOS version (project) and BIOS Build Date and Time.

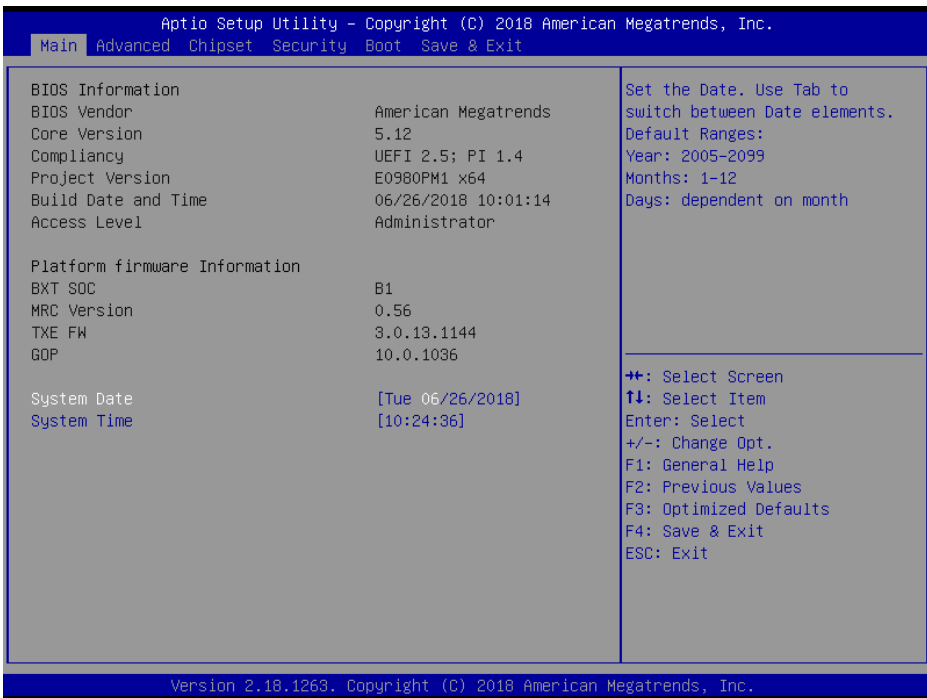

Main Screen

BIOS Setting	Options	Description/Purpose
BIOS Vendor	No changeable options	Displays the name of the BIOS vendor.
Core Version	No changeable options	Displays the current BIOS core version.
Compliancy	No changeable options	Displays the current UEFI version.
Project Version	No changeable options	Displays the version of the BIOS currently installed on the platform.
Build Date and Time	No changeable options	Displays the date that the current BIOS version is built.
Access Level	No changeable options	Displays the current user access level.
BXT SOC	No changeable options	Displays the SOC stepping.

BIOS Setting	Options	Description/Purpose
MRC Version	No changeable options	Displays the MRC version.
TXE FW	No changeable options	Displays the TXE FW version.
GOP	No changeable options	Displays the GOP version.
System Date	Month, day, year	Sets the system date. The format is [Day Month/ Date/ Year]. Users can directly enter values or use <+> or <-> arrow keys to increase/decrease it. The "Day" is automatically changed.
System Time	Hour, minute, second	Sets the system time. The format is [Hour: Minute: Second]. Users can directly enter values or use <+> or <-> arrow keys to increase/decrease it.

5.4 Advanced

Menu Path *Advanced*

This menu provides advanced configurations such as ACPI Settings, Onboard Device Configuration, Hardware Monitor, F81846 Watchdog, S5 RTC Wake Settings, CPU Configuration, F81846 Super IO Configuration, USB Configuration and Platform Trust Technology.

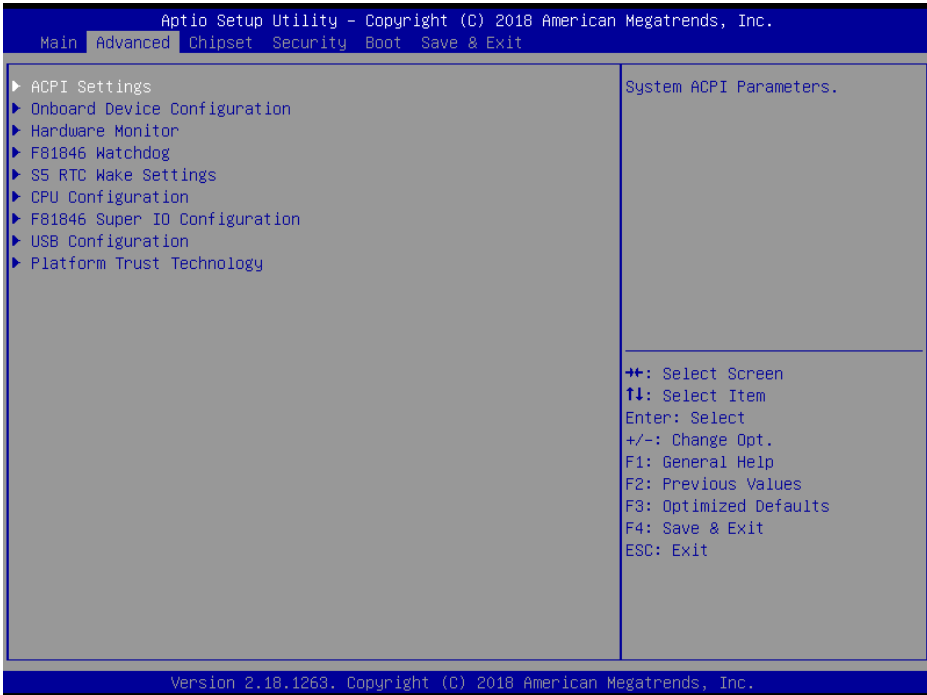

Advanced Menu Screen

BIOS Setting	Options	Description/Purpose
ACPI Settings	Sub-Menu	System ACPI parameters.
Onboard Device Configuration	Sub-Menu	Project specific parameters.
Hardware Monitor	Sub-Menu	Monitor hardware status.
F81846 Watchdog	Sub-Menu	Watchdog timer parameters.
S5 RTC Wake Settings	Sub-Menu	RTC wake parameters.
CPU Configuration	Sub-Menu	CPU configuration parameters.
F81846 Super IO Configuration	Sub-Menu	System Super IO chip parameters
USB Configuration	Sub-Menu	USB configuration parameters.
Platform Trust Technology	Sub-Menu	Platform Trust Technology parameter.

5.4.1 Advanced - ACPI Settings

Menu Path *Advanced > ACPI Settings*

The **ACPI Settings** allows users to configure relevant ACPI (Advanced Configuration and Power Management Interface) settings, such as Enable Hibernation (S4) and Enable Sleep (S3).

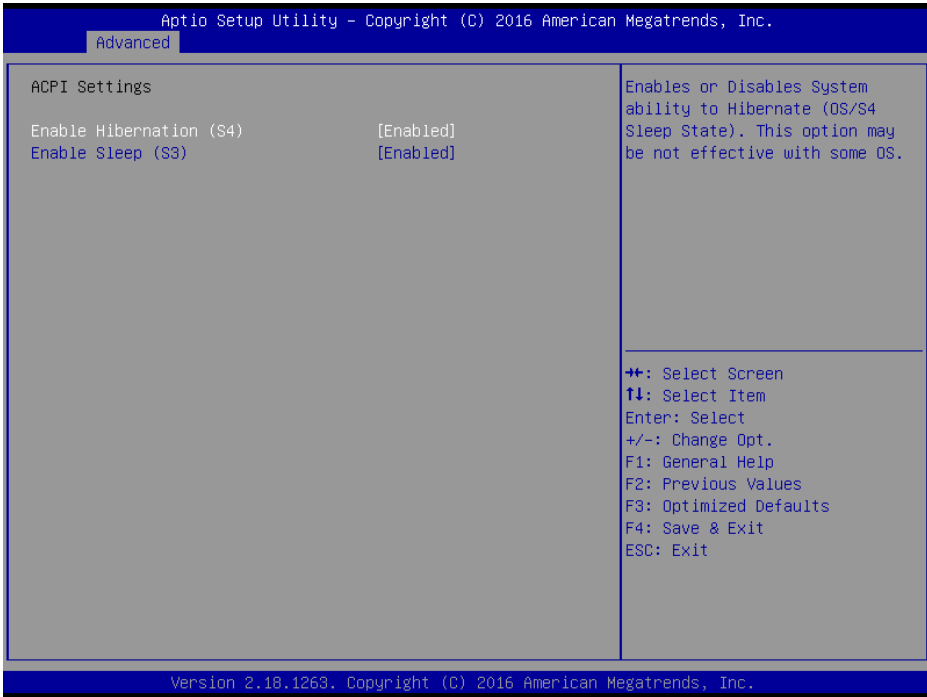

ACPI Settings Screen

BIOS Setting	Options	Description/Purpose
Enable Hibernation (S4)	- Disabled - Enabled (default)	Enables or Disables System ability to Hibernate (OS/S4 Sleep State). This option may be not effective with some OS.
Enable Sleep (S3)	- Disabled - Enabled (default)	Enables or Disables System ability to Sleep (OS/S3 Sleep State).

5.4.2 Advanced – Onboard Device Configuration

Menu Path *Advanced > Onboard Device Configuration*

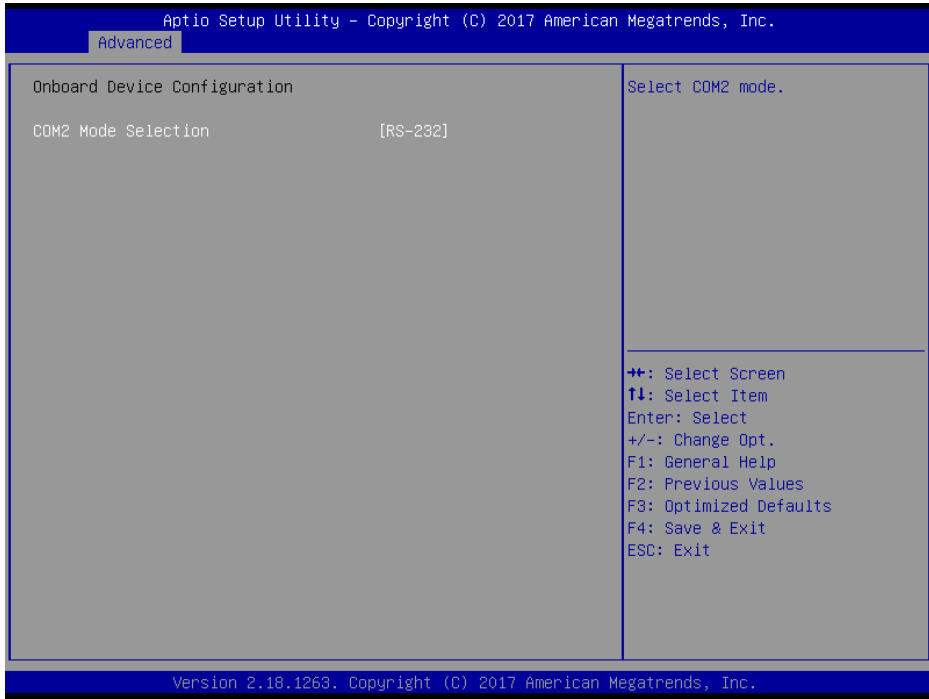

Onboard Device Configuration Screen

BIOS Setting	Options	Description/Purpose
COM2 Mode Selection	- RS-422 - RS-232 (default) - RS-485	Selects COM2 mode.

5.4.3 Advanced – Hardware Monitor

Menu Path *Advanced > Hardware Monitor*

The **Hardware Monitor** allows users to monitor the health and status of the system such as CPU temperature, system temperature, system fan speed and voltage levels in supply.

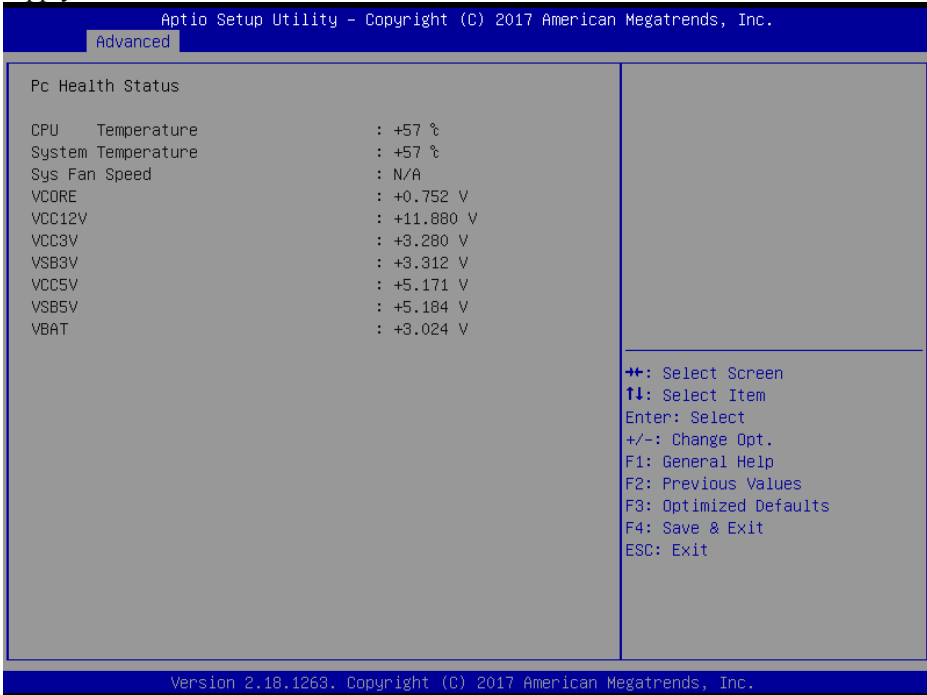

Hardware Monitor Screen

BIOS Setting	Options	Description/Purpose
CPU Temperature	No changeable options	Displays the processor's temperature.
System Temperature	No changeable options	Displays the system's temperature.
Sys Fan Speed	No changeable options	Displays system fan speed.
VCORE	No changeable options	Detects and displays the VCORE CPU voltage.
VCC12V	No changeable options	Detects and displays 12V voltage.
VCC3V	No changeable options	Detects and displays the voltage level of VCC3V in supply.
VSBB3V	No changeable options	Detects and displays VSB3V voltage.
VCC5V	No changeable options	Detects and displays the voltage level of VCC5V in supply.
VSBB5V	No changeable options	Detects and displays the voltage level of VSB5V in supply.

BIOS Setting	Options	Description/Purpose
VBAT	No changeable options	Detects and displays the battery voltage.

5.4.4 Advanced - F81846 Watchdog

Menu Path *Advanced > F81846 Watchdog*

If the system hangs or fails to respond, enable the F81846 watchdog function to trigger a system reset via the 255-level watchdog timer.

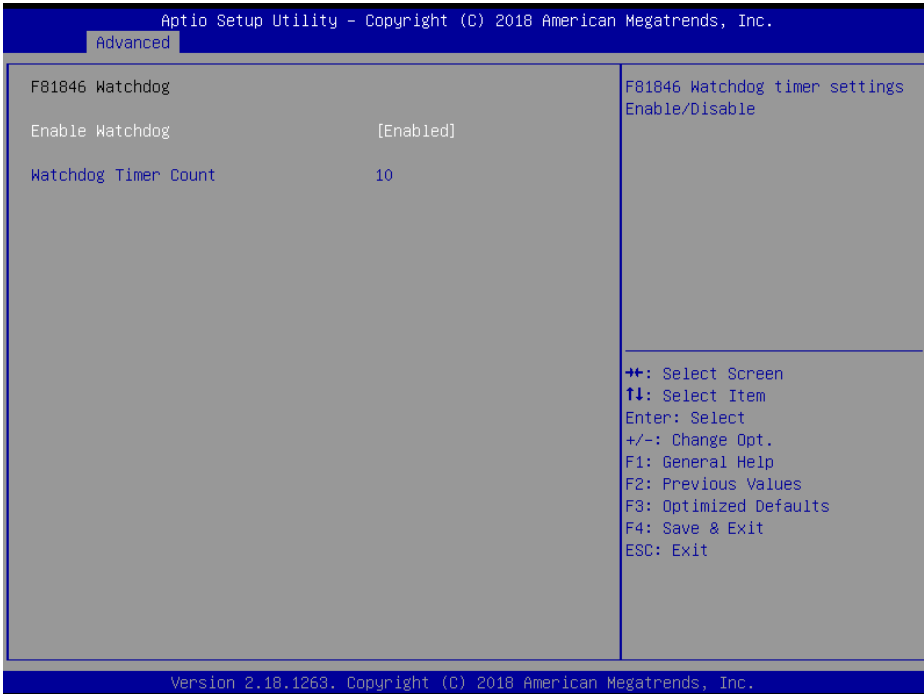

F81846 Watchdog Screen

BIOS Setting	Options	Description/Purpose
Enable Watchdog	- Disabled (default) - Enabled	Enables/Disables 81846 Watchdog timer settings.
Watchdog Timer Count	(Numeric) 10 to 255	Sets the timeout for Watchdog timer. Watchdog Timer = 1sec * Count

5.4.5 Advanced - S5 RTC Wake Settings

Menu Path *Advanced > S5 RTC wake Settings*

The **S5 RTC Wake Settings** enables/disables the system to wake up at a preset time of a day from S5 State using RTC alarm.



S5 RTC Wake Settings Screen

BIOS Setting	Options	Description/Purpose
Wake system from S5	<ul style="list-style-type: none"> - Disabled (default) - Fixed Time - Dynamic Time 	<p>Enables or disables System wake on alarm events.</p> <ul style="list-style-type: none"> • Fixed Time: The system will wake on the time (hr::min::sec) specified. • Dynamic Time: The system will wake on the current time + increased minute(s).

S5 RTC Wake Settings [Fixed Time]

Menu Path *Advanced > S5 RTC Wake Settings [Fixed Time]*

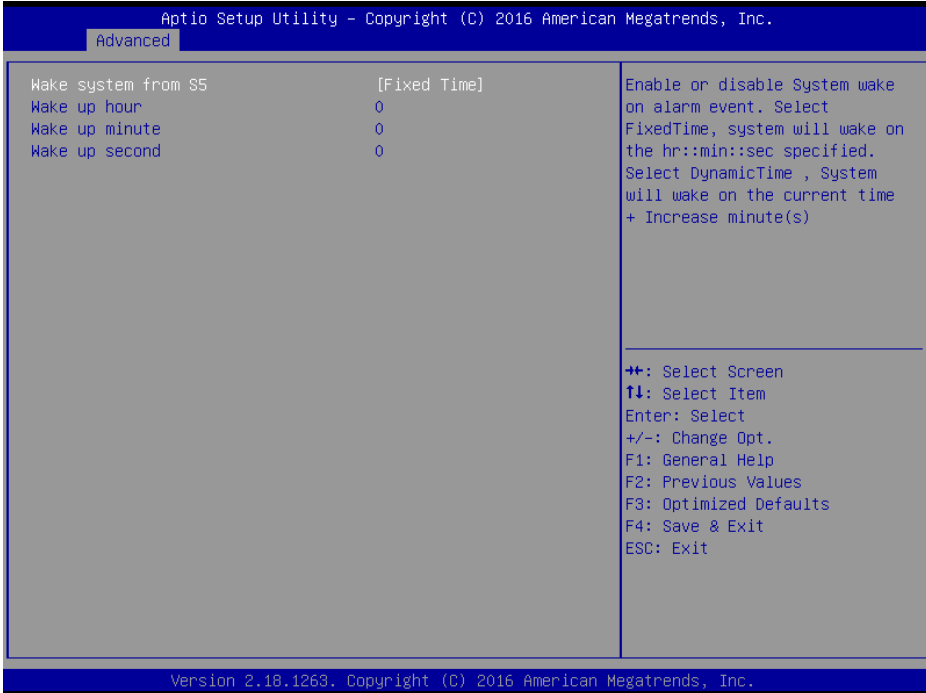

S5 RTC Wake Settings Screen (Fixed Time)

BIOS Setting	Options	Description/Purpose
Wake up hour	(Numeric) from 0 to 23	Sets an hour for a scheduled power-on event.
Wake up minute	(Numeric)from 0 to 59	Sets a minute for a scheduled power-on event.
Wake up second	(Numeric)from 0 to 59	Sets a second for a scheduled power-on event.

S5 RTC Wake Settings [Dynamic Time]

Menu Path *Advanced > S5 RTC Wake Settings [Dynamic Time]*

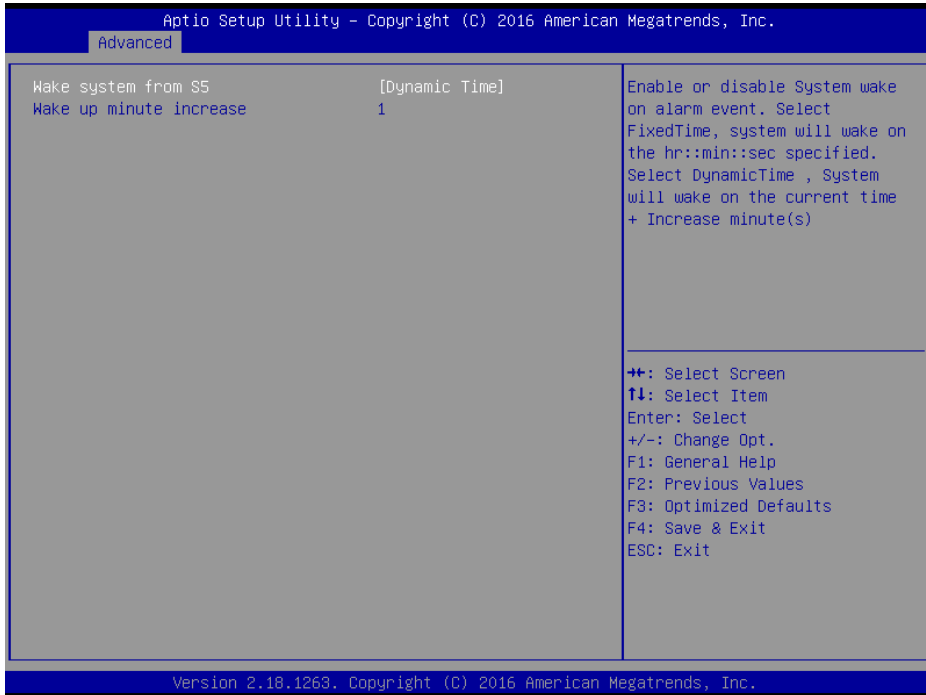

S5 RTC Wake Setting Screen (Dynamic Time)

BIOS Setting	Options	Description/Purpose
Wake up minute increase	(Numeric) from 1 to 5	Sets a period of time (in minutes) after which the board wakes up from S5 state.

5.4.6 Advanced - CPU Configuration

Menu Path *Advanced > CPU Configuration*

The **CPU Configuration** provides advanced CPU settings such as CPU power management and some information about CPU.

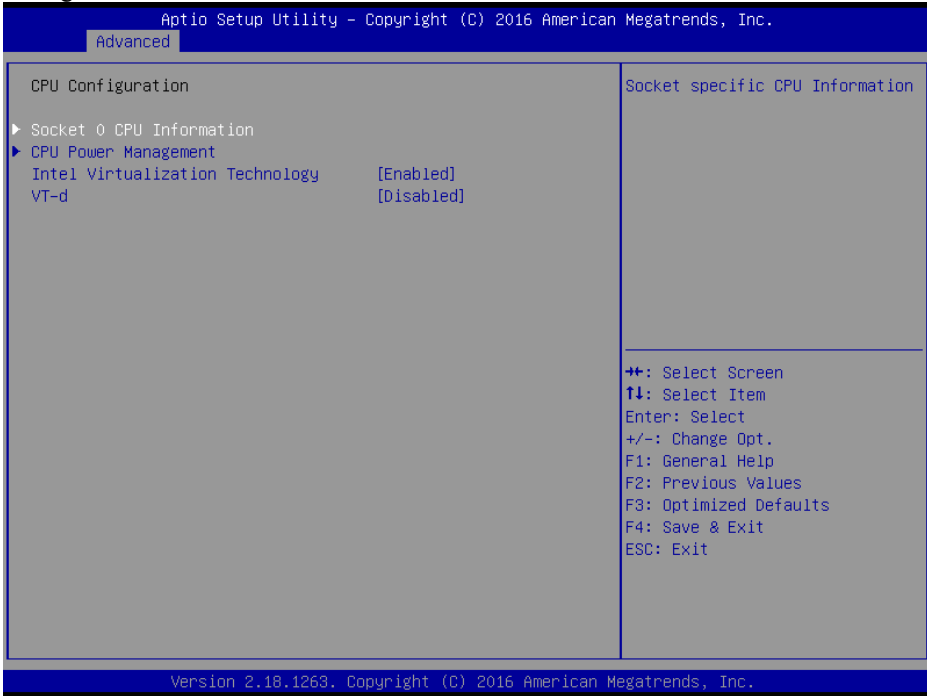

CPU Configuration Screen

BIOS Setting	Options	Description/Purpose
Socket 0 CPU Information	Sub-Menu	Socket-specific CPU Information.
CPU Power Management	Sub-Menu	CPU power management options.
Intel Virtualization Technology	- Disabled - Enabled (default)	When enabled, a VMM can utilize the additional hardware capabilities provided by Vanderpool Technology.
VT-d	- Disabled (default) - Enabled	Enables/Disables CPU VT-d.

Socket 0 CPU Information

Menu Path *Advanced > CPU Configuration > Socket 0 CPU Information*

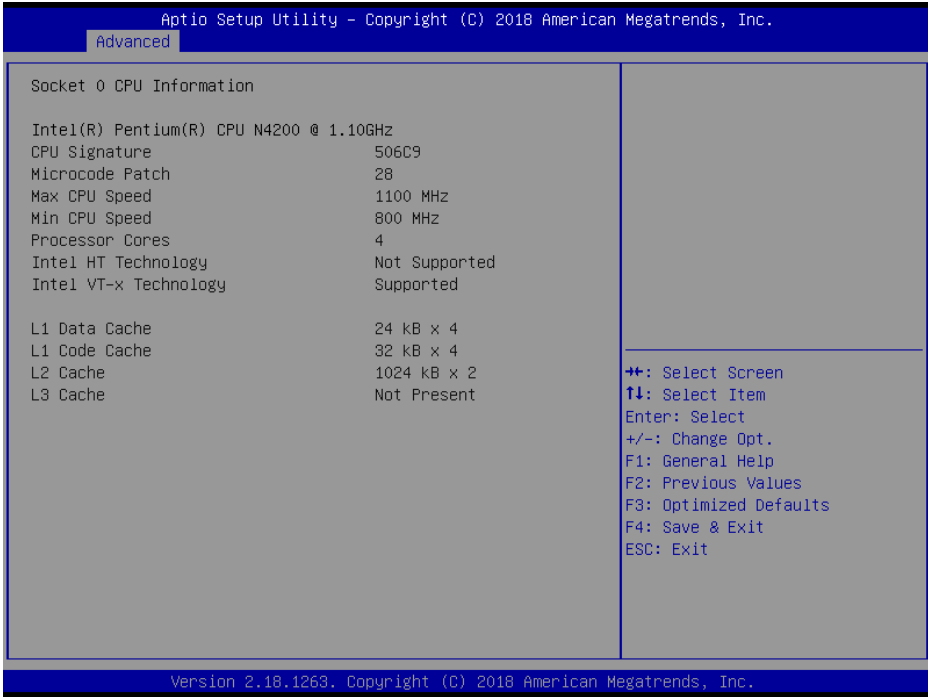

Socket 0 CPU Information Screen

BIOS Setting	Options	Description/Purpose
CPU Branding String	No changeable options	Displays CPU Branding String.
CPU Signature	No changeable options	Displays CPU Signature.
Microcode Patch	No changeable options	CPU Microcode Patch Revision.
Max CPU Speed	No changeable options	Displays the maximum CPU speed.
Min CPU Speed	No changeable options	Displays the minimum CPU speed.
Processor Cores	No changeable options	Displays the number of cores.
Intel HT Technology	No changeable options	Displays Hyper Threading support.
Intel VT-x Technology	No changeable options	Displays VT-x support.
L1 Data Cache	No changeable options	Displays L1 Data Cache size.
L1 Code Cache	No changeable options	Displays L1 Code Cache size.
L2 Cache	No changeable options	Displays L2 Cache size.
L3 Cache	No changeable options	Displays L3 Cache size.

CPU Power Management Configuration

Menu Path *Advanced > CPU Configuration > CPU Power Management Configuration*

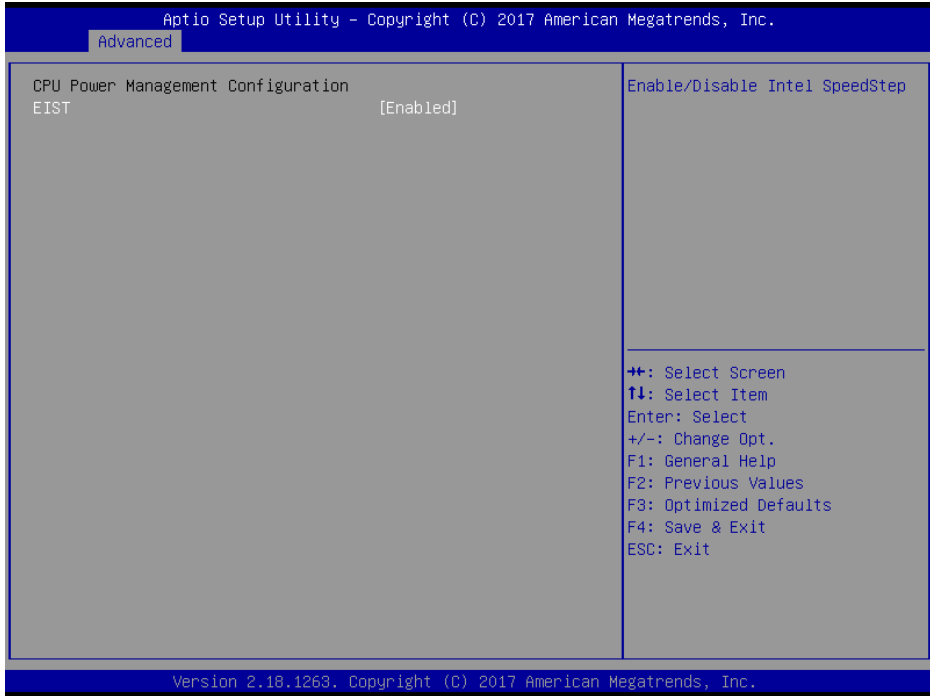

CPU Power Management Configuration Screen

BIOS Setting	Options	Description/Purpose
EIST	- Disabled - Enabled (default)	Enables/Disables Intel Speed Step feature for dynamic scaling processor frequency.

5.4.7 Advanced - F81846 Super IO Configuration

Menu Path *Advanced > F81846 Super IO Configuration*

The **F81846 Super IO Configuration** allows users to configure the serial ports 1-4.



F81846 Super IO Configuration Screen

BIOS Setting	Options	Description/Purpose
Super IO Chip (F81846)	No changeable options	Displays the super I/O chip model.
Serial Port 1 Configuration	Sub-Menu	COM1 parameters.
Serial Port 2 Configuration	Sub-Menu	COM2 parameters.
Serial Port 3 Configuration	Sub-Menu	COM3 parameters.
Serial Port 4 Configuration	Sub-Menu	COM4 parameters.

F81846 Super IO Configuration - Serial Port 1 Configuration

Menu Path *Advanced > F81846 Super IO Configuration > Serial Port 1 Configuration*

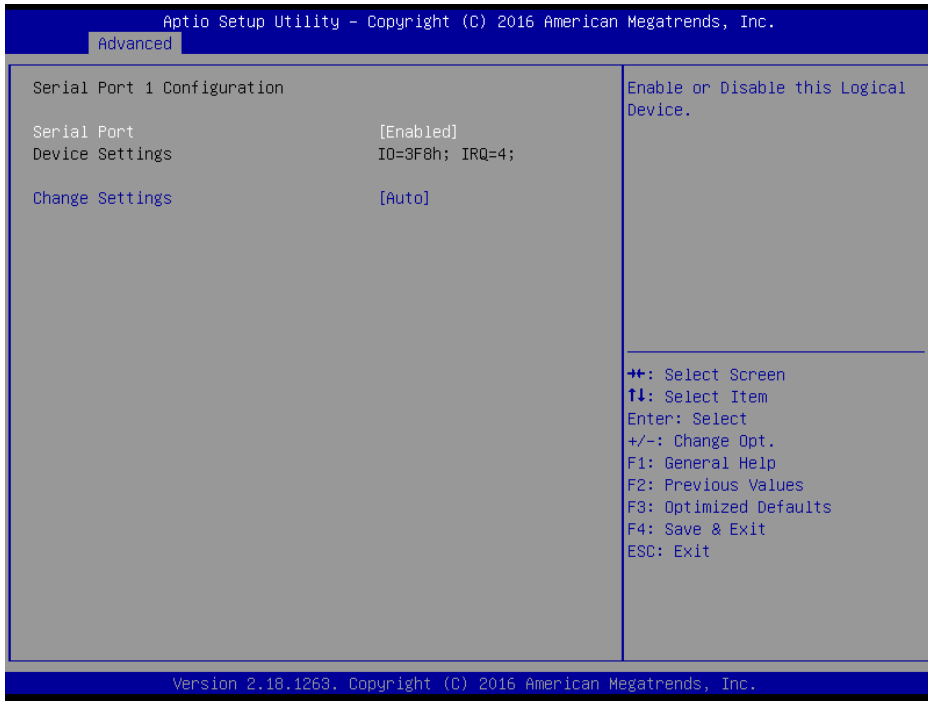

Serial Port 1 Configuration Screen

BIOS Setting	Options	Description/Purpose
Serial Port	- Disabled - Enabled (default)	Enables/Disables COM1.
Device Settings	No changeable options	Reports the current COM1 setting.
Change Settings	- Auto (default) - IO=3F8h; IRQ=4 - IO=3F8h; IRQ=3,4,5,7,9,10,11,12; - IO=2F8h; IRQ=3,4,5,7,9,10,11,12; - IO=3E8h; IRQ=3,4,5,7,9,10,11,12; - IO=2E8h; IRQ=3,4,5,7,9,10,11,12;	Allows users to change Device's Resource settings. New settings will be reflected on this Setup Page after System restarts.

F81846 Super IO Configuration - Serial Port 2 Configuration

Menu Path *Advanced > F81846 Super IO Configuration > Serial Port 2 Configuration*

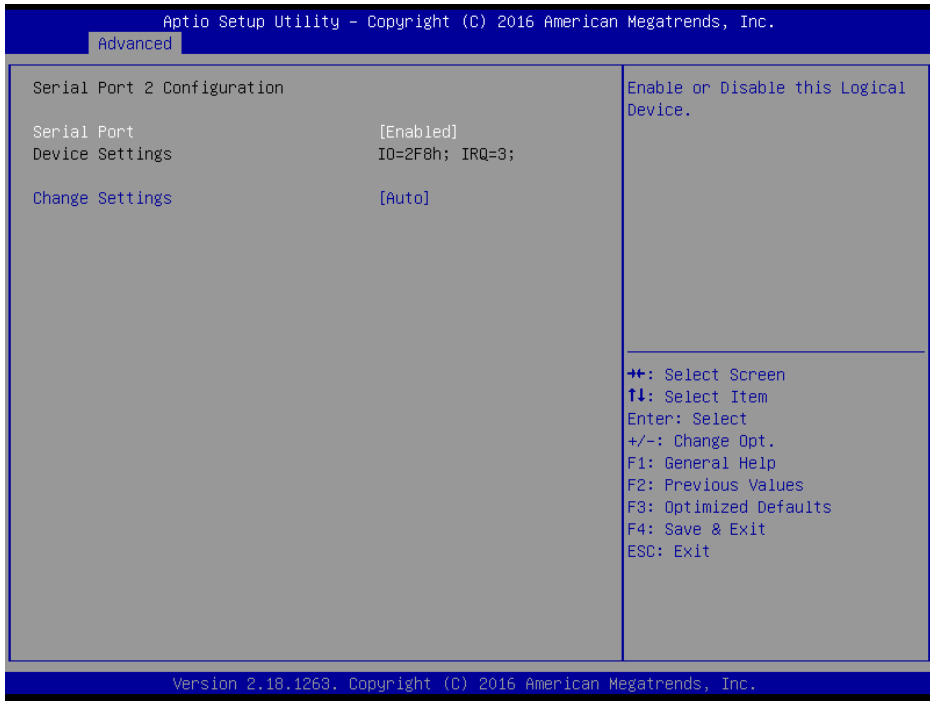

Serial Port 2 Configuration Screen

BIOS Setting	Options	Description/Purpose
Serial Port	- Disabled - Enabled (default)	Enables/Disables COM2.
Device Settings	No changeable options	Reports the current COM2 setting.
Change Settings	- Auto (default) - IO=2F8h; IRQ=3 - IO=3F8h; IRQ=3,4,5,7,9,10,11,12; - IO=2F8h; IRQ=3,4,5,7,9,10,11,12; - IO=3E8h; IRQ=3,4,5,7,9,10,11,12; - IO=2E8h; IRQ=3,4,5,7,9,10,11,12;	Allows users to change Device's Resource settings. New settings will be reflected on this Setup Page after System restarts.

F81846 Super IO Configuration - Serial Port 3 Configuration

Menu Path *Advanced > F81846 Super IO Configuration > Serial Port 3 Configuration*

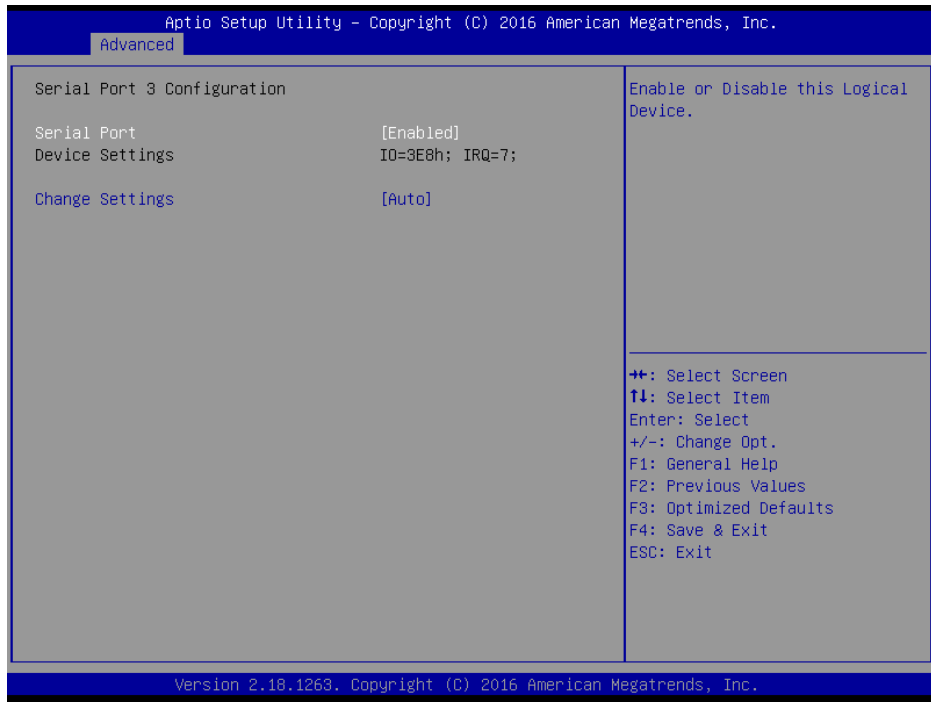

Serial Port 3 Configuration Screen

BIOS Setting	Options	Description/Purpose
Serial Port	- Disabled - Enabled (default)	Enables/Disables COM3.
Device Settings	No changeable options	Reports the current COM3 setting.
Change Settings	- Auto (default) - IO=3E8h; IRQ=7 - IO=3E8h; IRQ=3,4,5,7,9,10,11,12; - IO=2E8h; IRQ=3,4,5,7,9,10,11,12; - IO=2F0h; IRQ=3,4,5,7,9,10,11,12; - IO=2E0h; IRQ=3,4,5,7,9,10,11,12;	Allows users to change Device's Resource settings. New settings will be reflected on this Setup Page after System restarts.

F81846 Super IO Configuration - Serial Port 4 Configuration

Menu Path *Advanced > F81846 Super IO Configuration > Serial Port 4 Configuration*

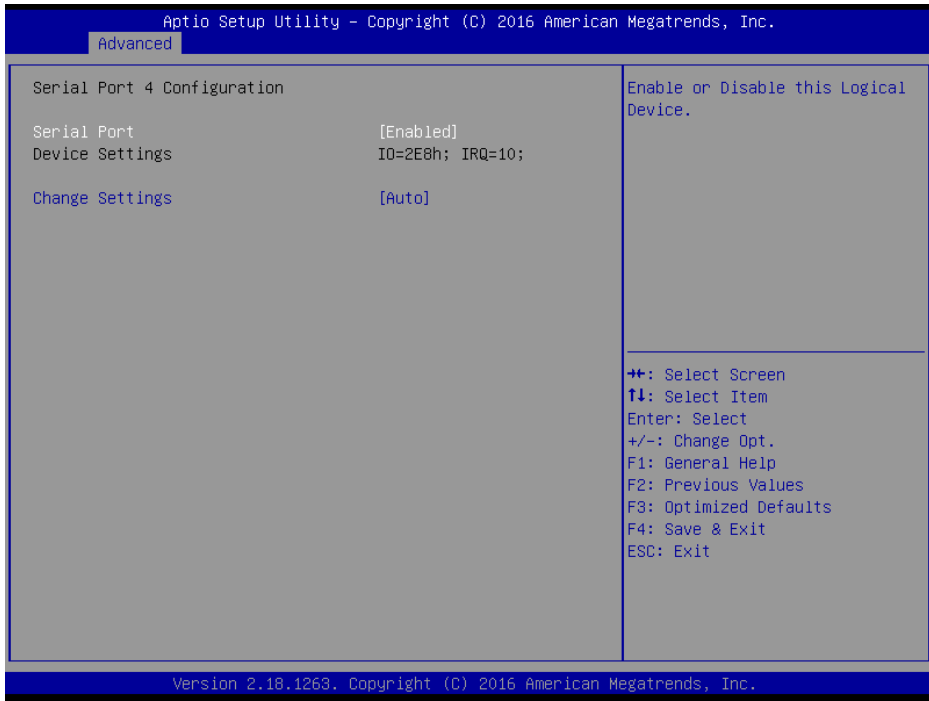

Serial Port 4 Configuration Screen

BIOS Setting	Options	Description/Purpose
Serial Port	- Disabled - Enabled (default)	Enables/Disables COM4.
Device Settings	No changeable options	Reports the current COM4 setting.
Change Settings	- Auto (default) - IO=2E8h; IRQ=10 - IO=3E8h; IRQ=3,4,5,7,9,10,11,12; - IO=2E8h; IRQ=3,4,5,7,9,10,11,12; - IO=2F0h; IRQ=3,4,5,7,9,10,11,12; - IO=2E0h; IRQ=3,4,5,7,9,10,11,12	Allows users to change Device's Resource settings. New settings will be reflected on this Setup Page after System restarts.

5.4.8 Advanced – USB Configuration

Menu Path *Advanced > USB Configuration*

The **USB Configuration** allows users to configure advanced USB settings such as USB mass storage driver support and mass storage devices.

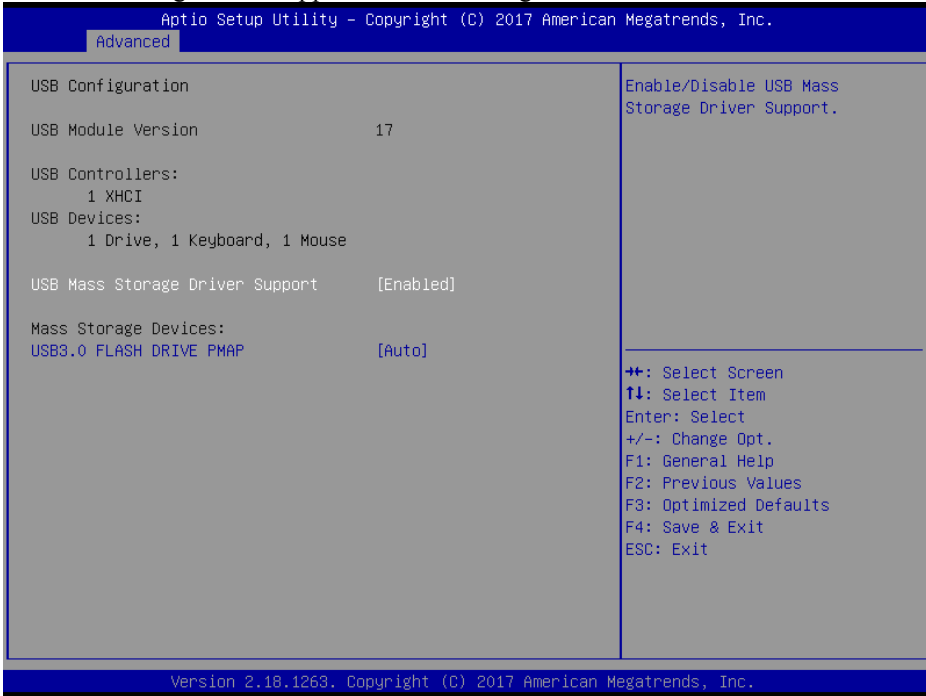

USB Configuration Screen

BIOS Setting	Options	Description/Purpose
USB Module Version	No changeable options	Displays USB module version.
USB Controllers	No changeable options	Displays number and type of USB controllers (if any).
USB Devices	No changeable options	Displays number and type of connected USB devices (if any).
USB Mass Storage Driver Support	- Disabled - Enabled (default)	Enables/ Disables USB Mass Storage Driver Support.
Mass Storage Devices: [drive(s)]	- Auto (default) - Floppy - Forced FDD - Hard Disk - CD-ROM	AUTO enumerates devices according to their media format. Optical drives are emulated as ' CD-ROM '. Drives with no media will be emulated according to a drive type.

5.4.9 Advanced – Platform Trust Technology

Menu Path *Advanced > Platform Trust Technology*

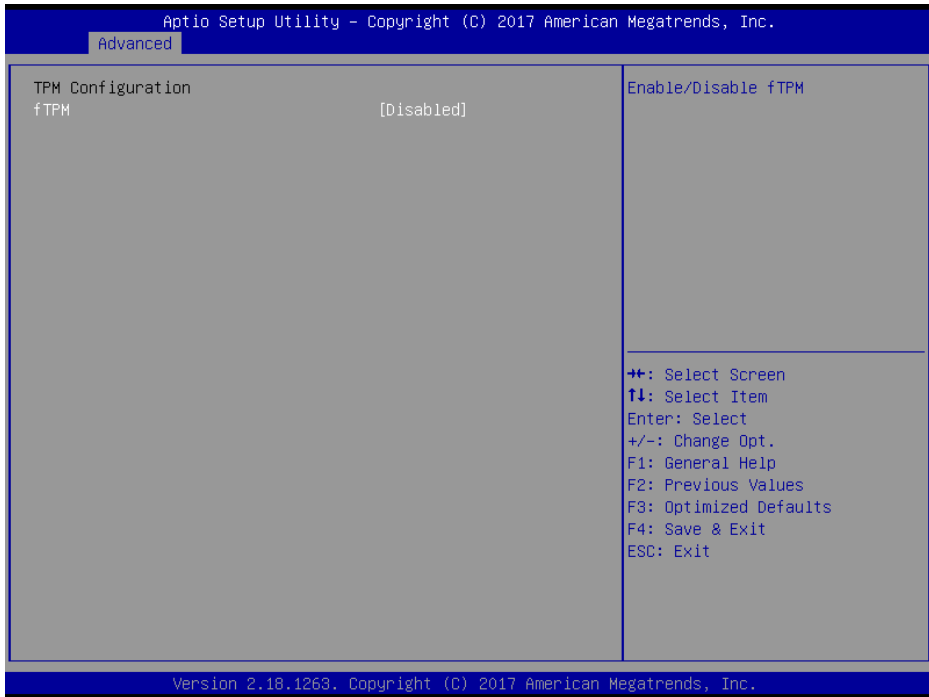

Platform Trust Technology Screen

BIOS Setting	Options	Description/Purpose
fTPM	- Enabled - Disabled (default)	Enables/Disables fTPM.

5.5 Chipset

Menu Path *Chipset*

This menu allows users to configure advanced Chipset settings such as North Bridge and South Bridge configuration parameters.

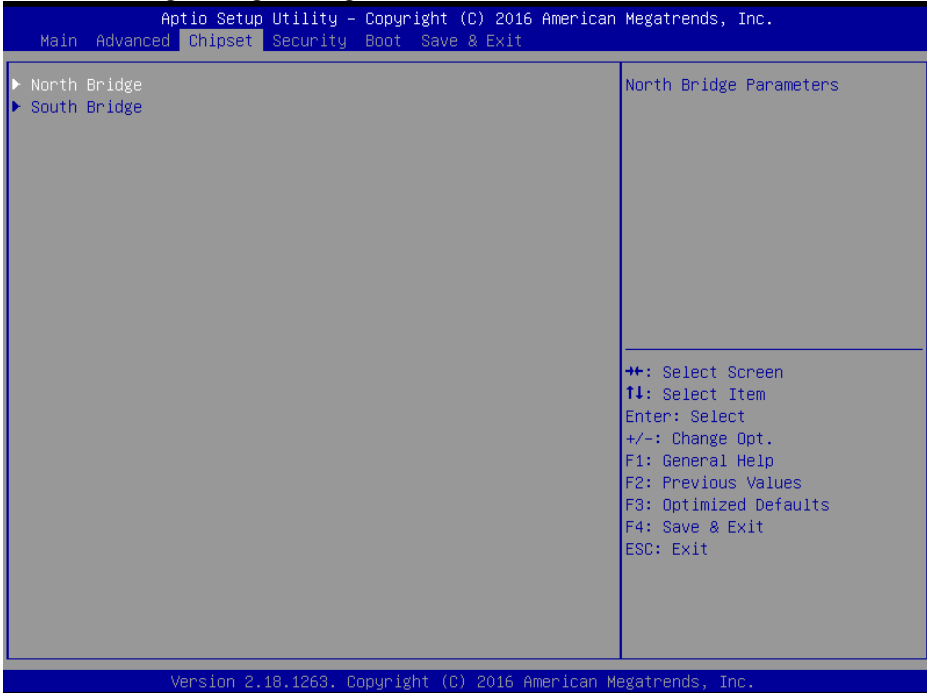

Chipset Screen

BIOS Setting	Options	Description/Purpose
North Bridge	Sub-menu	North Bridge Parameters.
South Bridge	Sub-menu	South Bridge Parameters.

5.5.1 Chipset - North Bridge

Menu Path *Chipset > North Bridge*

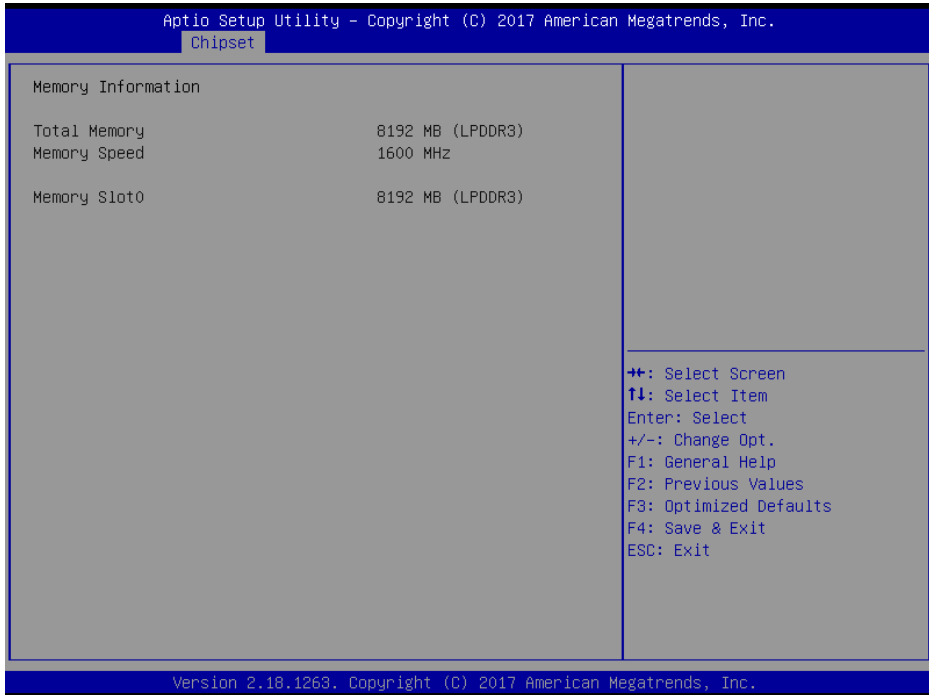

North Bridge Screen

BIOS Setting	Options	Description/Purpose
Total Memory	No changeable options	Displays the current amount and type of memory on the system, e.g. "8192 MB (LPDDR3)".
Memory Speed	No changeable options	Displays memory speed.
Memory Slot0	No changeable options	Displays the current amount and type of memory on each memory slot, e.g. "8192 MB (LPDDR3)".

5.5.2 Chipset - South Bridge

Menu Path *Chipset > South Bridge*

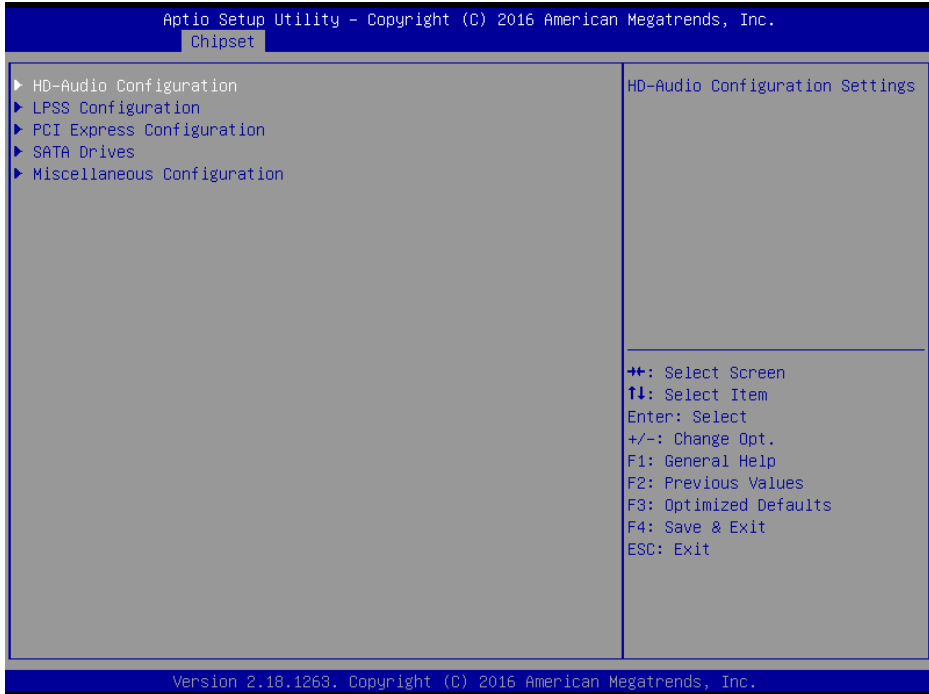

South Bridge Screen

BIOS Setting	Options	Description/Purpose
HD-Audio Configuration	Sub-Menu	HD-Audio configuration settings.
LPSS Configuration	Sub-Menu	LPSS configuration settings.
PCI Express Configuration	Sub-Menu	PCI Express configuration settings.
SATA Drives	Sub-Menu	SATA Drives configuration settings.
Miscellaneous Configuration	Sub-Menu	Miscellaneous configuration settings

South Bridge - HD-Audio Configuration

Menu Path *Chipset > South Bridge > HD-Audio Configuration*

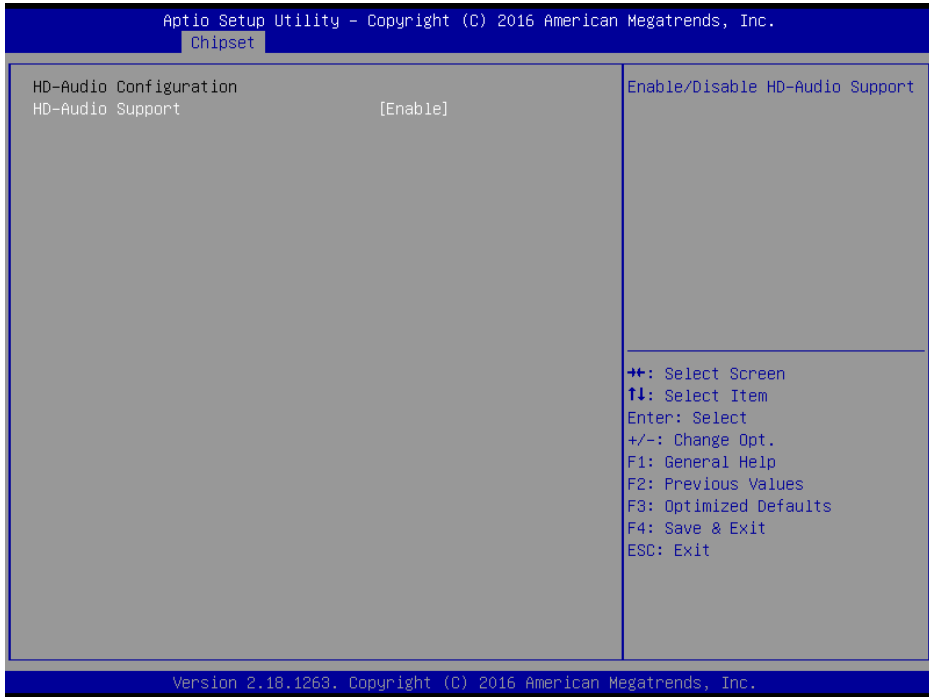

HD-Audio Configuration Screen

BIOS Setting	Options	Description/Purpose
HD-Audio Support	- Disable - Enable (default)	Enables/Disables HD-Audio support.

South Bridge - LPSS Configuration

Menu Path *Chipset > South Bridge > LPSS Configuration*

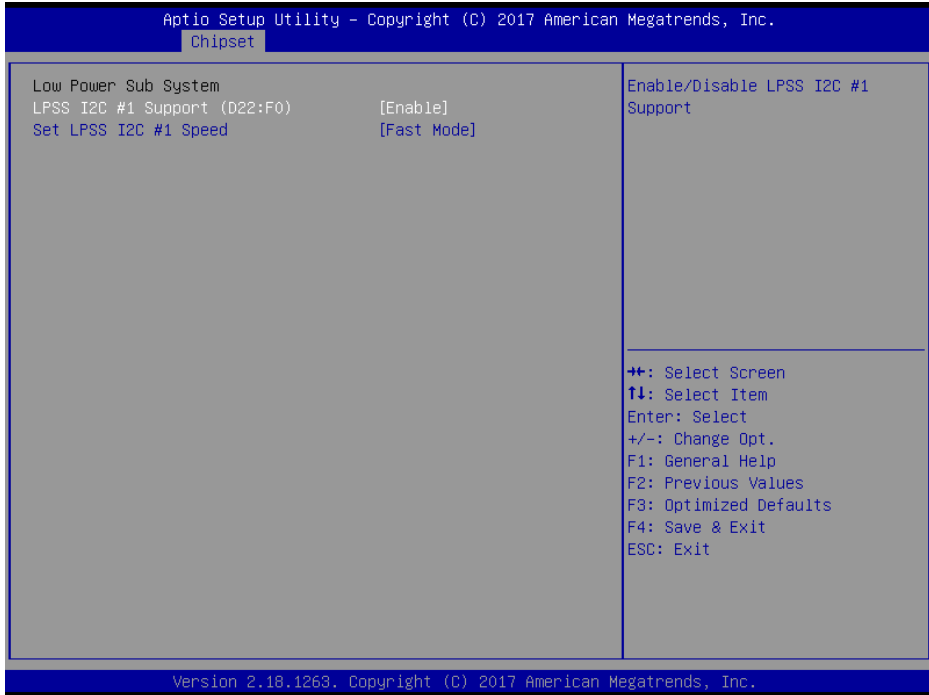

LPSS Configuration Screen

BIOS Setting	Options	Description/Purpose
LPSS I2C #1 Support (D22:F0)	- Disable - Enable (default)	Enables/Disables LPSS I2C #1 support.
Set LPSS I2C #1 Speed	- Standard Mode - Fast Mode (default) - Fast Plus Mode - High Speed Mode	Selects LPSS I2C #1 speed.

South Bridge - PCI Express Configuration

Menu Path *Chipset > South Bridge > PCI Express Configuration*

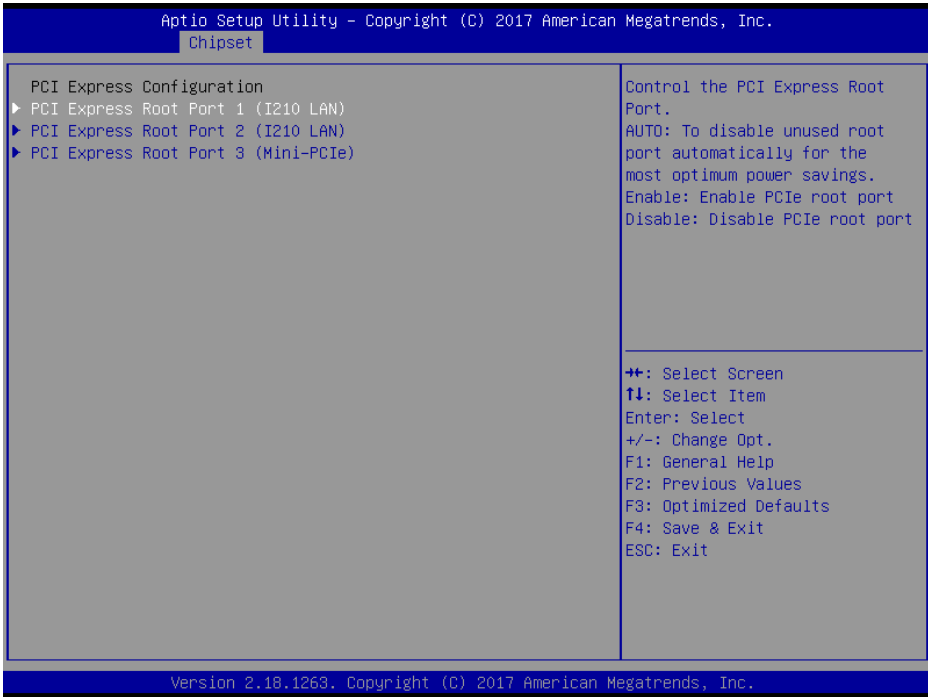

PCI Express Configuration Screen

BIOS Setting	Options	Description/Purpose
PCI Express Root Port 1 (I210 LAN)	Sub-Menu	PCIE RP1 parameters (I210 LAN).
PCI Express Root Port 2 (I210 LAN)	Sub-Menu	PCIE RP2 parameters (I210 LAN).
PCI Express Root Port 3 (Mini-PCIe)	Sub-Menu	PCIE RP3 parameters (Mini PCIe).

South Bridge - PCI Express Configuration - PCI Express Root Port 1

Menu Path *Chipset > South Bridge > PCI Express Configuration > PCI Express Root Port 1 (I210 LAN)*

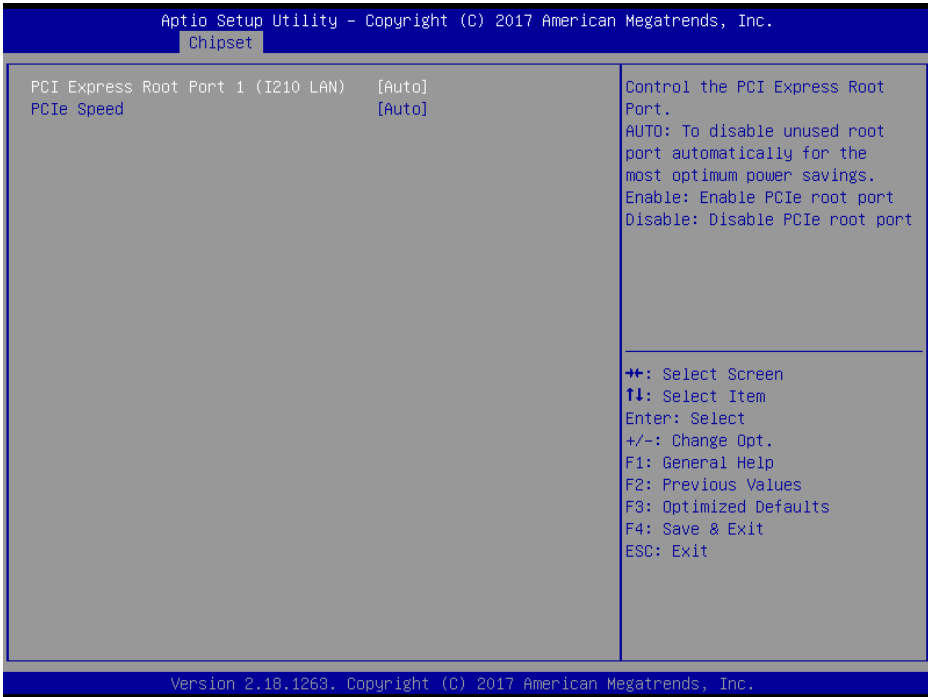

PCI Express Root Port 1 (I210 LAN) Screen

BIOS Setting	Options	Description/Purpose
PCI E Express Root Port 1	- Disable - Enable - Auto (default)	Enables/Disables PCIE root port 1 (I210 LAN).
PCIe Speed	- Auto (default) - Gen1 - Gen2	Configures PCIe speed.

South Bridge - PCI Express Configuration - PCI Express Root Port 2

Menu Path *Chipset > South Bridge > PCI Express Configuration > PCI Express Root Port 2 (I210 LAN)*

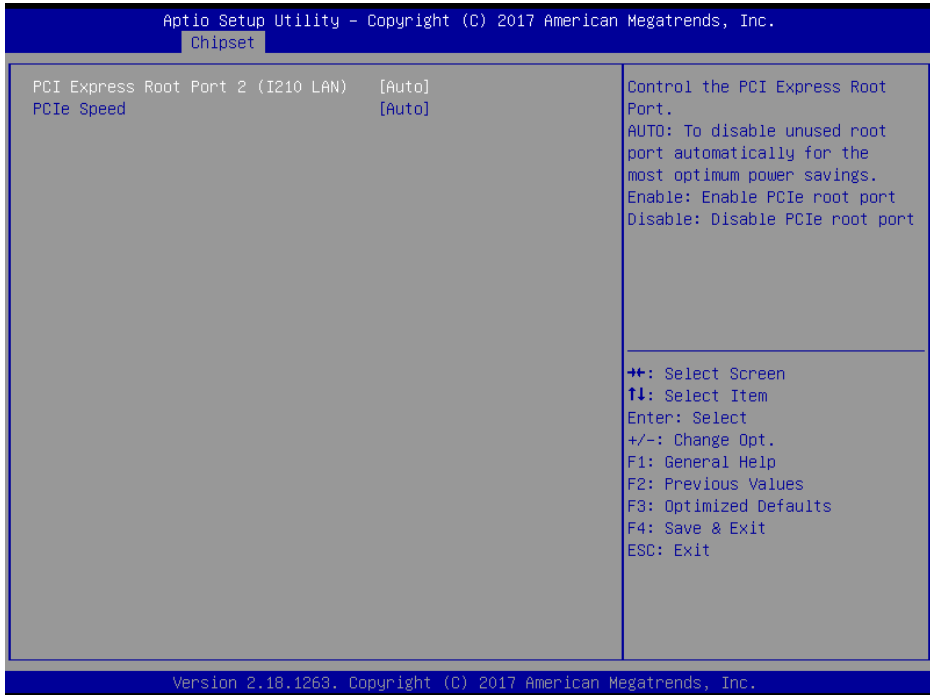

PCI Express Root Port 2 (I210 LAN) Screen

BIOS Setting	Options	Description/Purpose
PCI E Express Root Port 2 (I210 LAN)	- Disable - Enable - Auto (default)	Enables/Disables PCIE root port 2 (LAN I210).
PCIe Speed	- Auto (default) - Gen1 - Gen2	Configures PCIe speed.

South Bridge - PCI Express Configuration - PCI Express Root Port 3

Menu Path *Chipset > South Bridge > PCI Express Configuration > PCI Express Root Port 3 (Mini-PCIe)*

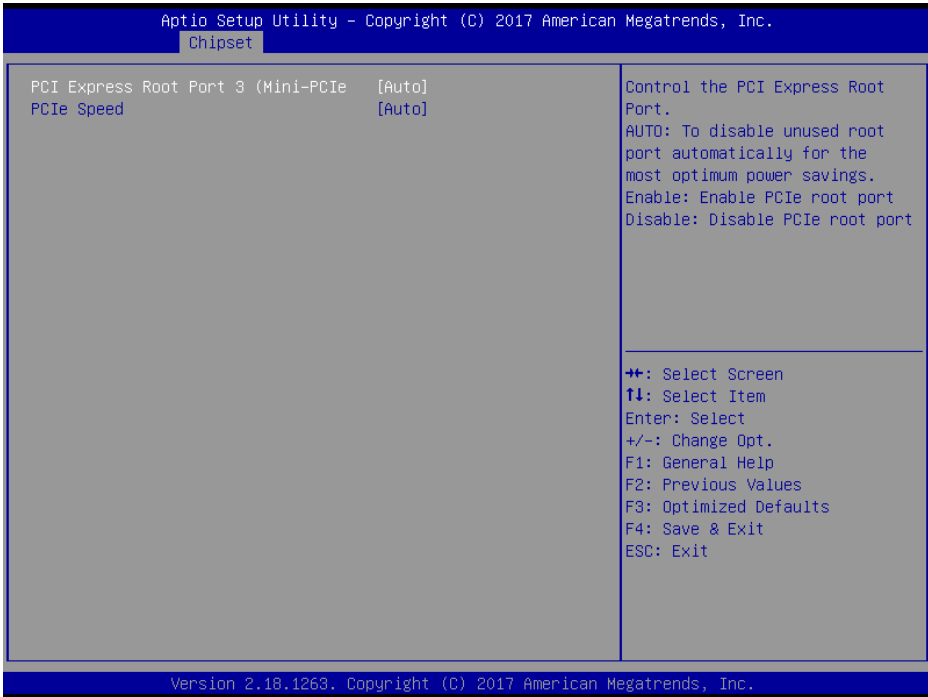

PCI Express Root Port 3 (Mini-PCIe) Screen

BIOS Setting	Options	Description/Purpose
PCI Express Root Port 3 (Mini-PCIe)	- Disable - Enable - Auto (default)	Enables/Disables PCIE root port 3 (Mini PCIe).
PCIe Speed	- Auto (default) - Gen1 - Gen2	Configures PCIe speed.

South Bridge - SATA Drives

Menu Path *Chipset > South Bridge > SATA Drives*

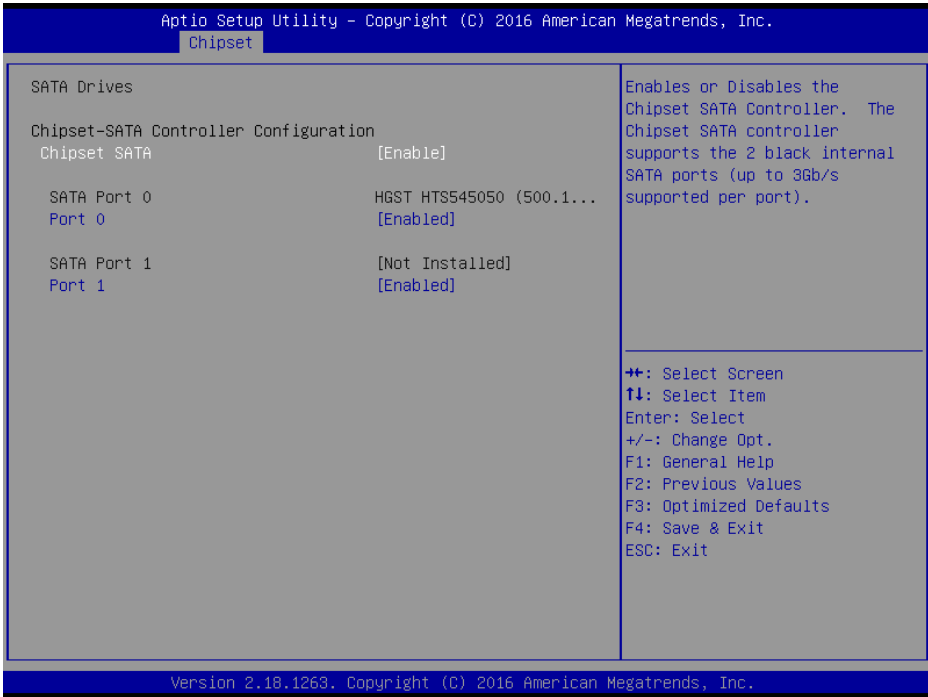

SATA Drives Screen

BIOS Setting	Options	Description/Purpose
Chipset SATA	- Enabled (default) - Disabled	Enables/Disables the chipset SATA controller.
SATA Port 0	No changeable options	Displays SATA drive branding information if device exists on port 0.
Port 0	- Disabled - Enabled (default)	Enables/Disables SATA port 0.
SATA Port 1	No changeable options	Displays SATA drive branding information if device exists on port 1.
Port 1	- Disabled - Enabled (default)	Enables/Disables SATA port 1.

South Bridge - Miscellaneous Configuration

Menu Path *Chipset > South Bridge > Miscellaneous Configuration*

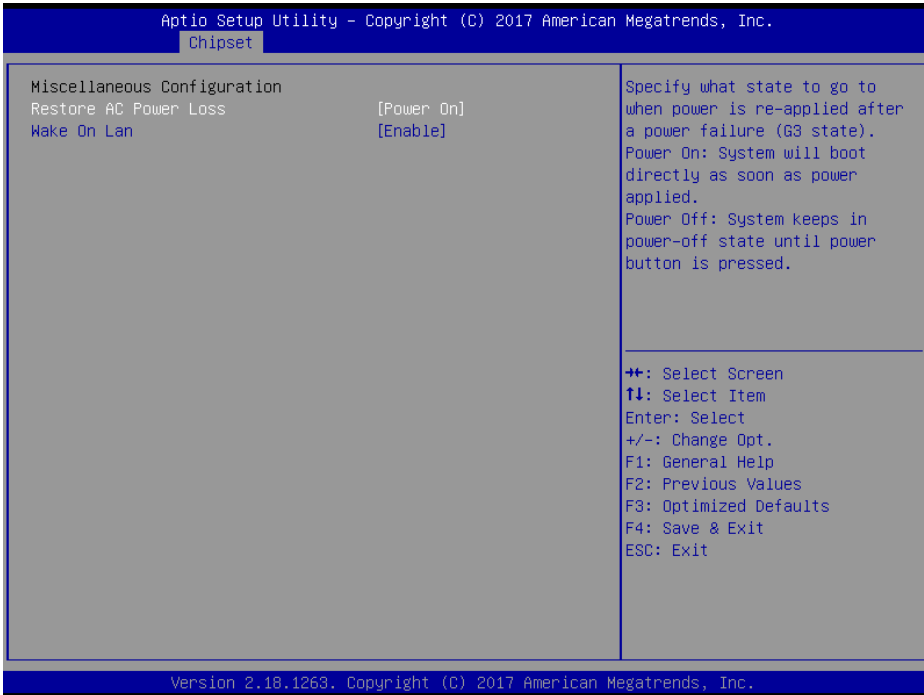

Miscellaneous Configuration Screen

BIOS Setting	Options	Description/Purpose
Restore AC Power Loss	- Power On (default) - Power Off	Specifies what state to go to when power is re-applied after a power failure (G3 state) occurs. <ul style="list-style-type: none"> • Power On: System will boot directly as soon as power is applied. • Power Off: System remains in power-off state unless the power button is pressed.
Wake On Lan	- Disable - Enable (default)	Enables or Disables the Wake On LAN (WOL). Win 8/8.1/10 don't support WOL from hybrid shutdown state (S4). If you want to support WOL from classic shutdown state (S5), please turn off 'fast startup' feature in OS.

5.6 Security

Menu Path *Security*

From the **Security** menu, you are allowed to create, change or clear the administrator password. You will be asked to enter the configured administrator password before you can access the Setup Utility.

By setting an administrator password, you will prevent other users from changing your BIOS settings. You can configure an Administrator password and then configure a user password. An administrator has much more privileges over the settings in the Setup utility than a user. Heed that a user password does not provide access to most of the features in the Setup utility.

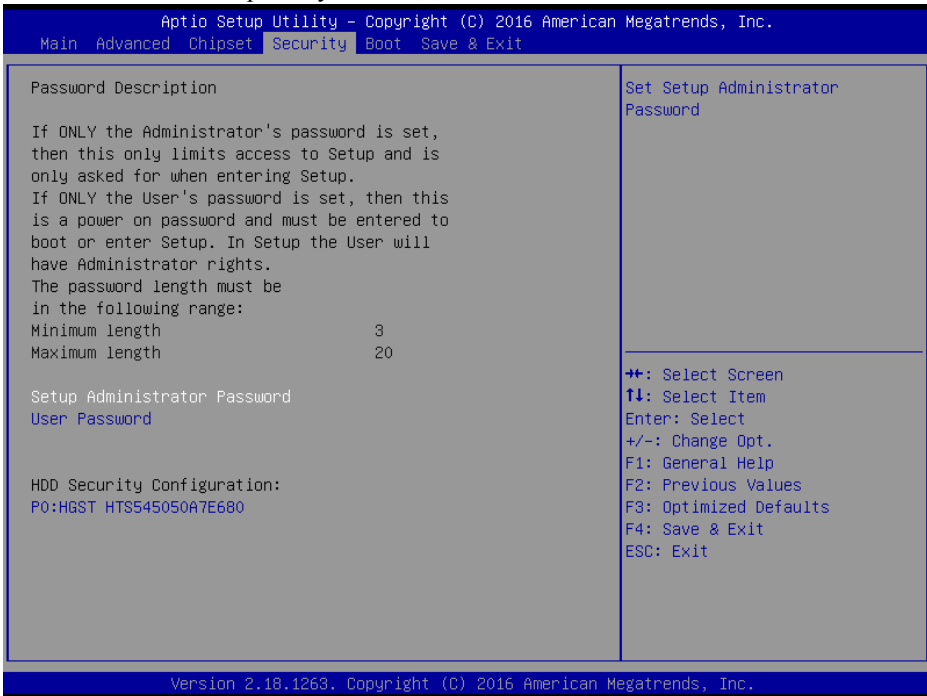

Security Screen

BIOS Setting	Options	Description/Purpose
Administrator Password	Password can be 3-20 alphanumeric characters.	Specifies the administrator password.

BIOS Setting	Options	Description/Purpose
User Password	Password can be 3-20 alphanumeric characters.	Specifies the user password.
HDD Security Configuration	Sub-Menu	Enters sub-menu with option to enabled password protected HDD/SSD (if supported by SATA device).

Create an Administrator or User Password

1. Select the **Administrator Password / User Password** option from the Security menu and press <Enter>, and the password dialog entry box appears.
2. Enter the password you want to create. A password can be 3-20 alphanumeric characters. After you have configured the password, press <Enter> to confirm.
3. Type the new password again and press <Enter>.

Change an Administrator or User Password

1. Select the **Administrator Password / User Password** option from the Security menu and press <Enter>, and the password dialog entry box appears.
2. Select the Administrator Password or User Password that you want to change. A password can be 3-20 alphanumeric characters. After you have changed the password, press <Enter> to confirm.
3. Type the changed password again and press <Enter>.

Remove an Administrator or User Password

1. Select the **Administrator Password / User Password** option from the Security menu and press <Enter>, and the password dialog entry box appears.
2. Select the configured Administrator Password or User Password that you want to delete. Leave the dialog box blank and press <Enter>.
3. Press <Enter> again when the password confirmation box appears.

5.7 Boot

Menu Path *Boot*

This menu provides control items for setting system boot configuration and boot priorities.

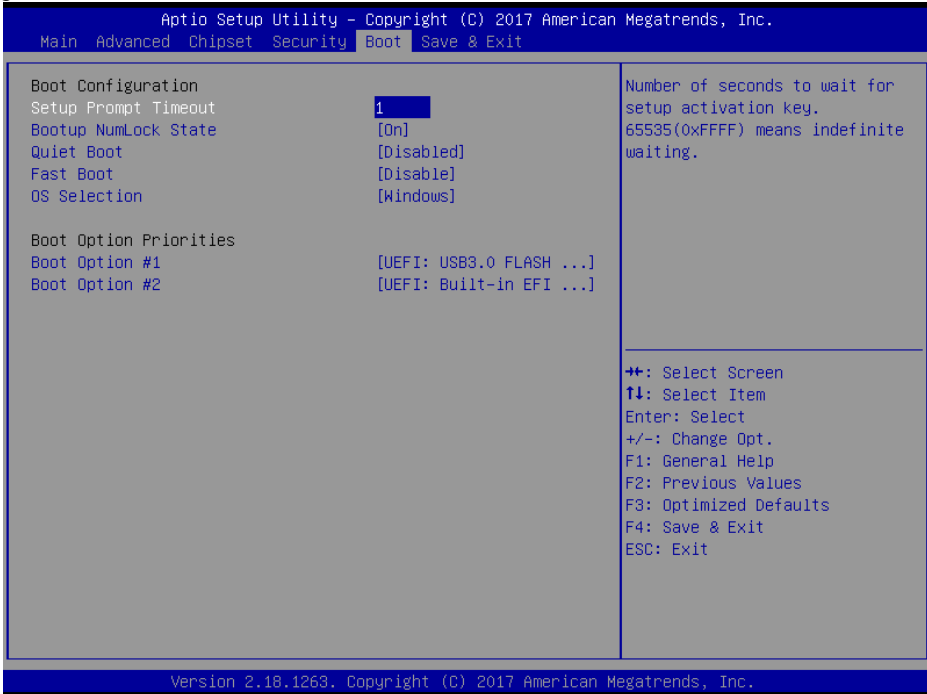

Boot Screen

BIOS Setting	Options	Description/Purpose
Setup Prompt Timeout	(Numeric) from 1 to 65535.	Number of seconds to wait for setup activation key.
Bootup NumLock State	- On (default) - Off	Selects the NumLock state after the system is powered on. <ul style="list-style-type: none"> • On: Enables the NumLock function automatically after the system is powered on. • Off: Disables the NumLock function after the system is powered on.
Quiet Boot	- Disabled (default) - Enabled	When quiet boot is enabled, it displays AMI or OEM logo (if

BIOS Setting	Options	Description/Purpose
		implemented) instead of POST messages during the boot.
Fast Boot	- Disabled (default) - Enabled	Enables or Disables Fast Boot Options.
OS Selection	- Windows (default) - Android - Intel Linux	Selects the target OS.
Boot Option #1~#n	- [Drive(s)] - Disabled	Sets the system boot order.

5.8 Save & Exit

Menu Path *Save & Exit*

The **Save & Exit** allows users to save or discard changed BIOS settings as well as load factory default settings.

Save Changed BIOS Settings

To save and validate the changed BIOS settings, select **Save Changes** from the **Save & Exit** menu, or you can select **Save Changes and Exit** (or press **F4**) to validate the changes and then exit the system. Select **Save Changes and Reset** to validate the changed BIOS settings and then restart the system

Discard Changed BIOS Settings

To cancel the BIOS settings you have previously configured, select **Discard Changes and Exit** from this menu, or simply press **Esc** to exit the BIOS setup. You can also select **Discard Changes and Reset** to discard any changes you have made and restore the factory BIOS defaults.

Load User Defaults

You may simply press **F3** at any time to load the **Optimized Values** which resets all BIOS settings to the factory defaults.

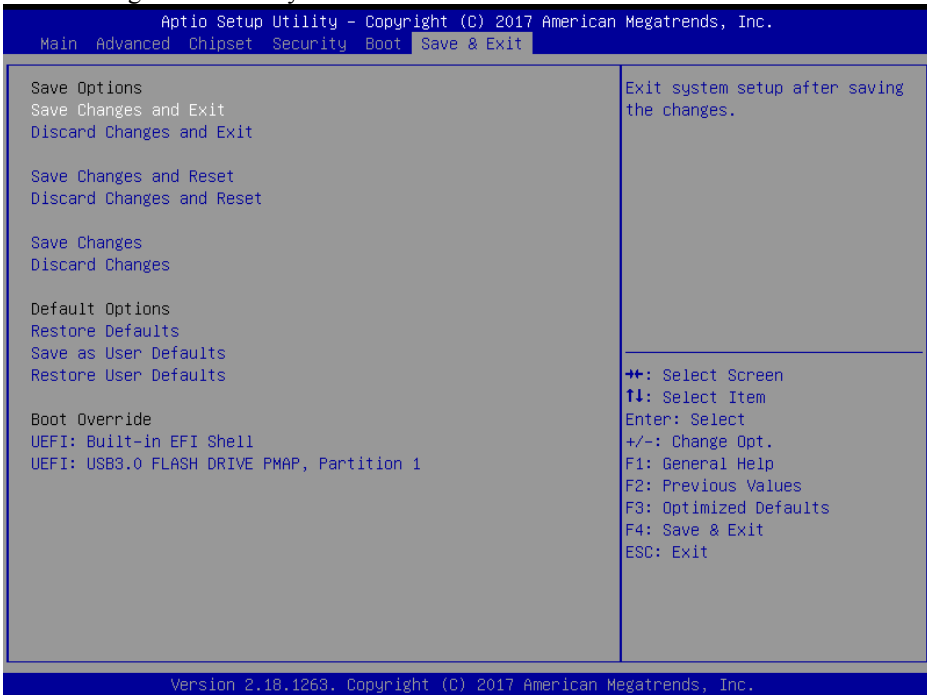

Save & Exit Screen

BIOS Setting	Options	Description/Purpose
Save Changes and Exit	No changeable options	Exits and saves the changes in NVRAM.
Discard Changes and Exit	No changeable options	Exits without saving any changes made in BIOS settings.
Save Changes and Reset	No changeable options	Saves the changes in NVRAM and resets.
Discard Changes and Reset	No changeable options	Resets without saving any changes made in BIOS settings.
Save Changes	No changeable options	Save Changes done so far to any of the setup options.
Discard Changes	No changeable options	Discard Changes done so far to any of the setup options.
Restore Defaults	No changeable options	Loads the optimized defaults for BIOS settings.
Save as User Defaults	No changeable options	Save the changes done so far as User Defaults.
Restore User Defaults	No changeable options	Restore the User Defaults to all the setup options.
Boot Override	- [Drive(s)]	Forces to boot from selected [drive(s)].

Appendix A System Diagrams

This appendix provides exploded diagrams and part numbers of BS-E098 system.

The following topics are included:

- BS-E098 System Exploded Diagram
- BS-E098 SATA HDD Exploded Diagram

BS-E098 System Exploded Diagram

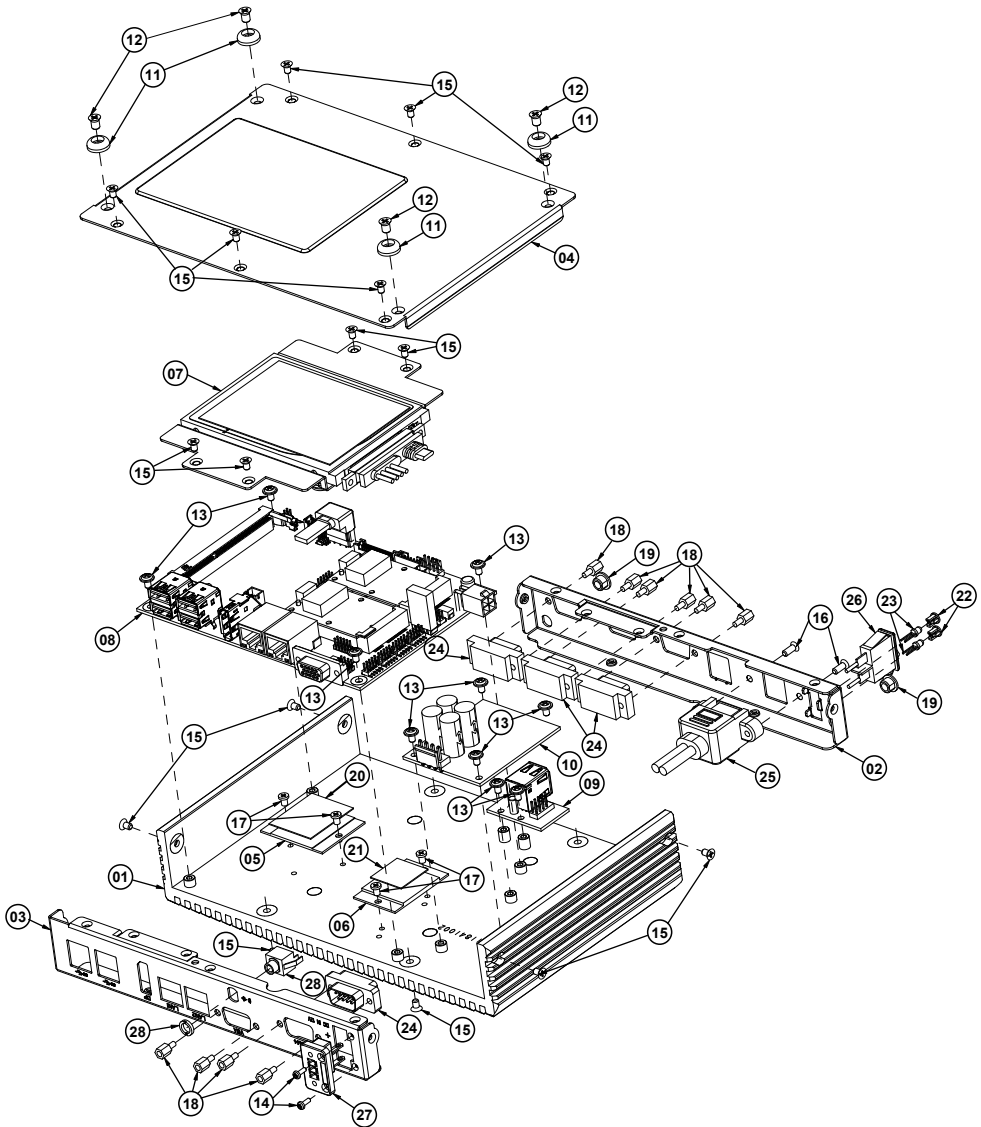

ITEM	Description	Part No.	Q'ty
1	BS-E981 HEATSINK CASE (Black)	81-002-11841002	1
2	BS-E981 FRONT CASE (Black)	80-001-03063395	1
3	BS-E981 Back CASE (Black)	80-001-03061395	1
4	BS-E981 BOT CASE (w/Paint) (Black)	80-001-03062395	1
5	APOLLO LAKE-I CPU BLOCK	21-002-14032001	1
6	BS-E981 U32 BLOCK	21-002-14027002	1
7	BS-E981 2INCH HDD SATA KIT	See Page A-3 and A-4	1
8	MAINBOARD	BE-0981	1
9	USB BOARD	52-152-00861000	1
10	POWER BOARD	TDB(Optional kits)	1
11	RUBBER FOOT (11.1 X 3.96 mm) (Black)	90-004-01400000	4
12	FLAT HEAD SCREW M4x0.7Px6mm (Black)	22-215-40006011	4
13	ROUND WASHER HEAD SCREW M3x0.5Px5mm	22-242-30005311	10
14	PAN HEAD SCREW M2.0x0.4Px6mm	22-222-20060011	2
15	FLAT HEAD SCREW #2/M3x0.5Px5mm (Black)	22-215-30005011	18
16	FLAT HEAD SCREW #2/M3x0.5Px8mm (Black)	22-215-30008011	2
17	FILLISTR HEAD SCREW #1/M3x0.5Px4mm	22-272-30004011	4
18	HEX CU BOSS UNC No.4-40, L=4.8, H=7mm	22-692-40048051	10
19	HOLE PLUG (Φ6.6mm) (Black)	90-067-01100000	2
20	Thermal Interface Pads, 32x27x1mm (Reddish Gray)	21-006-83227001	1
21	Thermal Interface Pads, 20x20x1mm (Reddish Gray)	21-006-82020003	1
22	LED HOUSING (Black)	30-014-04100165	2
23/26	LED CABLE (2 IN 1) POWER SWITCH CABLE	27-019-39503071	1
24	COM CABLE	27-024-39505031 (x3) 27-024-39505032 (x1)	4
25	USB *2 CABLE	27-006-39504111	1
27	POWER CABLE (DC IN to Daughter board) L=160mm	27-012-39503071	1
28	PHONE JACK CABLE	27-028-39503111	1

BS-E098 SATA HDD Exploded Diagram

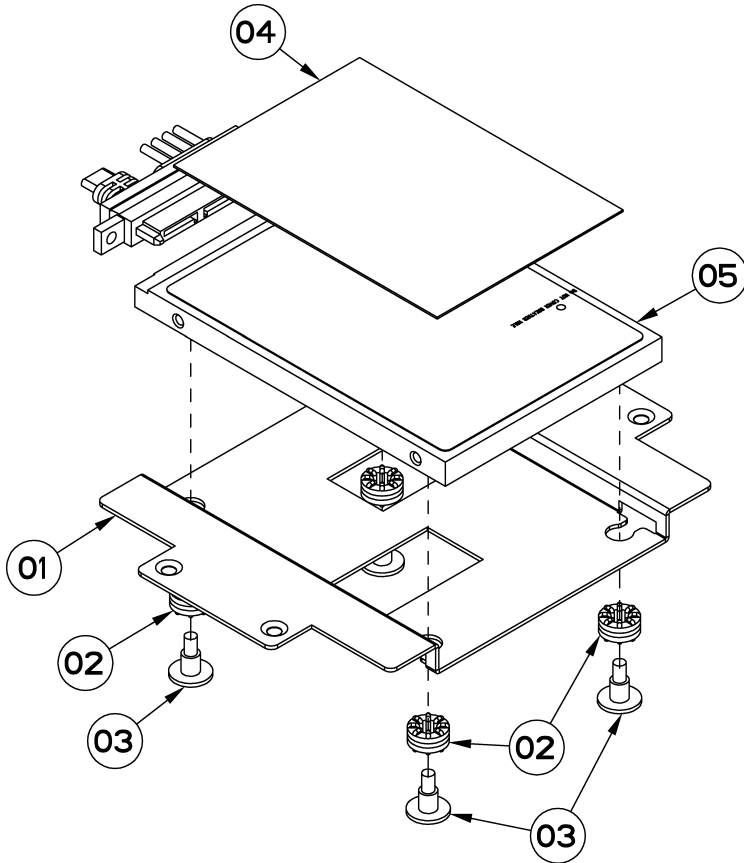

ITEM	Description	Part No.	Q'ty
1	BS-E981 HDD SUPPORT	80-002-03001395	1
2	RUBBER WASHER (OD=φ9.62mm,ID=φ3.9mmx5.8T)(Blue)	23-680-39580963	4
3	FILLISTER HEAD SCREW M3x0.5Px4.8mm	82-272-30005013	4
4	Thermal Interface Pads, 85x60x0.5mm (Dark Gray)	21-006-88560001	1
5	2.5" HDD SATA	27-008-39503081	1

Appendix B Technical Summary

This appendix will give you a brief introduction of the allocation maps for BS-E098 resources.

The following topics are included:

- Interrupt Map
- I/O Map
- Memory Map
- Configuring WatchDog Timer
- Flash BIOS Update

Interrupt Map

IRQ	Assignment
IRQ 0	System timer
IRQ 3	Communications Port (COM2)
IRQ 4	Communications Port (COM1)
IRQ 7	Communications Port (COM3)
IRQ 8	System CMOS/real time clock
IRQ 10	Communications Port (COM4)
IRQ 25	High Definition Audio Controller
IRQ 27	Intel(R) Serial IO I2C Host Controller - 5AAC
IRQ 54	Microsoft ACPI-Compliant System
IRQ 55	Microsoft ACPI-Compliant System
IRQ 56	Microsoft ACPI-Compliant System
IRQ 57	Microsoft ACPI-Compliant System
IRQ 58	Microsoft ACPI-Compliant System
IRQ 59	Microsoft ACPI-Compliant System
IRQ 60	Microsoft ACPI-Compliant System
IRQ 61	Microsoft ACPI-Compliant System
IRQ 62	Microsoft ACPI-Compliant System
IRQ 63	Microsoft ACPI-Compliant System
IRQ 64	Microsoft ACPI-Compliant System
IRQ 65	Microsoft ACPI-Compliant System
IRQ 66	Microsoft ACPI-Compliant System
IRQ 67	Microsoft ACPI-Compliant System
IRQ 68	Microsoft ACPI-Compliant System
IRQ 69	Microsoft ACPI-Compliant System
IRQ 70	Microsoft ACPI-Compliant System
IRQ 71	Microsoft ACPI-Compliant System
IRQ 72	Microsoft ACPI-Compliant System
IRQ 73	Microsoft ACPI-Compliant System
IRQ 74	Microsoft ACPI-Compliant System
IRQ 75	Microsoft ACPI-Compliant System
IRQ 76	Microsoft ACPI-Compliant System
IRQ 77	Microsoft ACPI-Compliant System
IRQ 78	Microsoft ACPI-Compliant System
IRQ 79	Microsoft ACPI-Compliant System
IRQ 80	Microsoft ACPI-Compliant System
IRQ 81	Microsoft ACPI-Compliant System
IRQ 82	Microsoft ACPI-Compliant System

IRQ	Assignment
IRQ 83	Microsoft ACPI-Compliant System
IRQ 84	Microsoft ACPI-Compliant System
IRQ 85	Microsoft ACPI-Compliant System
IRQ 86	Microsoft ACPI-Compliant System
IRQ 87	Microsoft ACPI-Compliant System
IRQ 88	Microsoft ACPI-Compliant System
IRQ 89	Microsoft ACPI-Compliant System
IRQ 90	Microsoft ACPI-Compliant System
IRQ 91	Microsoft ACPI-Compliant System
IRQ 92	Microsoft ACPI-Compliant System
IRQ 93	Microsoft ACPI-Compliant System
IRQ 94	Microsoft ACPI-Compliant System
IRQ 95	Microsoft ACPI-Compliant System
IRQ 96	Microsoft ACPI-Compliant System
IRQ 97	Microsoft ACPI-Compliant System
IRQ 98	Microsoft ACPI-Compliant System
IRQ 99	Microsoft ACPI-Compliant System
IRQ 100	Microsoft ACPI-Compliant System
IRQ 101	Microsoft ACPI-Compliant System
IRQ 102	Microsoft ACPI-Compliant System
IRQ 103	Microsoft ACPI-Compliant System
IRQ 104	Microsoft ACPI-Compliant System
IRQ 105	Microsoft ACPI-Compliant System
IRQ 106	Microsoft ACPI-Compliant System
IRQ 107	Microsoft ACPI-Compliant System
IRQ 108	Microsoft ACPI-Compliant System
IRQ 109	Microsoft ACPI-Compliant System
IRQ 110	Microsoft ACPI-Compliant System
IRQ 111	Microsoft ACPI-Compliant System
IRQ 112	Microsoft ACPI-Compliant System
IRQ 113	Microsoft ACPI-Compliant System
IRQ 114	Microsoft ACPI-Compliant System
IRQ 115	Microsoft ACPI-Compliant System
IRQ 116	Microsoft ACPI-Compliant System
IRQ 117	Microsoft ACPI-Compliant System
IRQ 118	Microsoft ACPI-Compliant System
IRQ 119	Microsoft ACPI-Compliant System
IRQ 120	Microsoft ACPI-Compliant System
IRQ 121	Microsoft ACPI-Compliant System
IRQ 122	Microsoft ACPI-Compliant System

IRQ	Assignment
IRQ 123	Microsoft ACPI-Compliant System
IRQ 124	Microsoft ACPI-Compliant System
IRQ 125	Microsoft ACPI-Compliant System
IRQ 126	Microsoft ACPI-Compliant System
IRQ 127	Microsoft ACPI-Compliant System
IRQ 128	Microsoft ACPI-Compliant System
IRQ 129	Microsoft ACPI-Compliant System
IRQ 130	Microsoft ACPI-Compliant System
IRQ 131	Microsoft ACPI-Compliant System
IRQ 132	Microsoft ACPI-Compliant System
IRQ 133	Microsoft ACPI-Compliant System
IRQ 134	Microsoft ACPI-Compliant System
IRQ 135	Microsoft ACPI-Compliant System
IRQ 136	Microsoft ACPI-Compliant System
IRQ 137	Microsoft ACPI-Compliant System
IRQ 138	Microsoft ACPI-Compliant System
IRQ 139	Microsoft ACPI-Compliant System
IRQ 140	Microsoft ACPI-Compliant System
IRQ 141	Microsoft ACPI-Compliant System
IRQ 142	Microsoft ACPI-Compliant System
IRQ 143	Microsoft ACPI-Compliant System
IRQ 144	Microsoft ACPI-Compliant System
IRQ 145	Microsoft ACPI-Compliant System
IRQ 146	Microsoft ACPI-Compliant System
IRQ 147	Microsoft ACPI-Compliant System
IRQ 148	Microsoft ACPI-Compliant System
IRQ 149	Microsoft ACPI-Compliant System
IRQ 150	Microsoft ACPI-Compliant System
IRQ 151	Microsoft ACPI-Compliant System
IRQ 152	Microsoft ACPI-Compliant System
IRQ 153	Microsoft ACPI-Compliant System
IRQ 154	Microsoft ACPI-Compliant System
IRQ 155	Microsoft ACPI-Compliant System
IRQ 156	Microsoft ACPI-Compliant System
IRQ 157	Microsoft ACPI-Compliant System
IRQ 158	Microsoft ACPI-Compliant System
IRQ 159	Microsoft ACPI-Compliant System
IRQ 160	Microsoft ACPI-Compliant System
IRQ 161	Microsoft ACPI-Compliant System
IRQ 162	Microsoft ACPI-Compliant System

IRQ	Assignment
IRQ 163	Microsoft ACPI-Compliant System
IRQ 164	Microsoft ACPI-Compliant System
IRQ 165	Microsoft ACPI-Compliant System
IRQ 166	Microsoft ACPI-Compliant System
IRQ 167	Microsoft ACPI-Compliant System
IRQ 168	Microsoft ACPI-Compliant System
IRQ 169	Microsoft ACPI-Compliant System
IRQ 170	Microsoft ACPI-Compliant System
IRQ 171	Microsoft ACPI-Compliant System
IRQ 172	Microsoft ACPI-Compliant System
IRQ 173	Microsoft ACPI-Compliant System
IRQ 174	Microsoft ACPI-Compliant System
IRQ 175	Microsoft ACPI-Compliant System
IRQ 176	Microsoft ACPI-Compliant System
IRQ 177	Microsoft ACPI-Compliant System
IRQ 178	Microsoft ACPI-Compliant System
IRQ 179	Microsoft ACPI-Compliant System
IRQ 180	Microsoft ACPI-Compliant System
IRQ 181	Microsoft ACPI-Compliant System
IRQ 182	Microsoft ACPI-Compliant System
IRQ 183	Microsoft ACPI-Compliant System
IRQ 184	Microsoft ACPI-Compliant System
IRQ 185	Microsoft ACPI-Compliant System
IRQ 186	Microsoft ACPI-Compliant System
IRQ 187	Microsoft ACPI-Compliant System
IRQ 188	Microsoft ACPI-Compliant System
IRQ 189	Microsoft ACPI-Compliant System
IRQ 190	Microsoft ACPI-Compliant System
IRQ 191	Microsoft ACPI-Compliant System
IRQ 192	Microsoft ACPI-Compliant System
IRQ 193	Microsoft ACPI-Compliant System
IRQ 194	Microsoft ACPI-Compliant System
IRQ 195	Microsoft ACPI-Compliant System
IRQ 196	Microsoft ACPI-Compliant System
IRQ 197	Microsoft ACPI-Compliant System
IRQ 198	Microsoft ACPI-Compliant System
IRQ 199	Microsoft ACPI-Compliant System
IRQ 200	Microsoft ACPI-Compliant System
IRQ 201	Microsoft ACPI-Compliant System
IRQ 202	Microsoft ACPI-Compliant System

IRQ	Assignment
IRQ 203	Microsoft ACPI-Compliant System
IRQ 204	Microsoft ACPI-Compliant System
IRQ 256	Microsoft ACPI-Compliant System
IRQ 257	Microsoft ACPI-Compliant System
IRQ 258	Microsoft ACPI-Compliant System
IRQ 259	Microsoft ACPI-Compliant System
IRQ 260	Microsoft ACPI-Compliant System
IRQ 261	Microsoft ACPI-Compliant System
IRQ 262	Microsoft ACPI-Compliant System
IRQ 263	Microsoft ACPI-Compliant System
IRQ 264	Microsoft ACPI-Compliant System
IRQ 265	Microsoft ACPI-Compliant System
IRQ 266	Microsoft ACPI-Compliant System
IRQ 267	Microsoft ACPI-Compliant System
IRQ 268	Microsoft ACPI-Compliant System
IRQ 269	Microsoft ACPI-Compliant System
IRQ 270	Microsoft ACPI-Compliant System
IRQ 271	Microsoft ACPI-Compliant System
IRQ 272	Microsoft ACPI-Compliant System
IRQ 273	Microsoft ACPI-Compliant System
IRQ 274	Microsoft ACPI-Compliant System
IRQ 275	Microsoft ACPI-Compliant System
IRQ 276	Microsoft ACPI-Compliant System
IRQ 277	Microsoft ACPI-Compliant System
IRQ 278	Microsoft ACPI-Compliant System
IRQ 279	Microsoft ACPI-Compliant System
IRQ 280	Microsoft ACPI-Compliant System
IRQ 281	Microsoft ACPI-Compliant System
IRQ 282	Microsoft ACPI-Compliant System
IRQ 283	Microsoft ACPI-Compliant System
IRQ 284	Microsoft ACPI-Compliant System
IRQ 285	Microsoft ACPI-Compliant System
IRQ 286	Microsoft ACPI-Compliant System
IRQ 287	Microsoft ACPI-Compliant System
IRQ 288	Microsoft ACPI-Compliant System
IRQ 289	Microsoft ACPI-Compliant System
IRQ 290	Microsoft ACPI-Compliant System
IRQ 291	Microsoft ACPI-Compliant System
IRQ 292	Microsoft ACPI-Compliant System
IRQ 293	Microsoft ACPI-Compliant System

IRQ	Assignment
IRQ 294	Microsoft ACPI-Compliant System
IRQ 295	Microsoft ACPI-Compliant System
IRQ 296	Microsoft ACPI-Compliant System
IRQ 297	Microsoft ACPI-Compliant System
IRQ 298	Microsoft ACPI-Compliant System
IRQ 299	Microsoft ACPI-Compliant System
IRQ 300	Microsoft ACPI-Compliant System
IRQ 301	Microsoft ACPI-Compliant System
IRQ 302	Microsoft ACPI-Compliant System
IRQ 303	Microsoft ACPI-Compliant System
IRQ 304	Microsoft ACPI-Compliant System
IRQ 305	Microsoft ACPI-Compliant System
IRQ 306	Microsoft ACPI-Compliant System
IRQ 307	Microsoft ACPI-Compliant System
IRQ 308	Microsoft ACPI-Compliant System
IRQ 309	Microsoft ACPI-Compliant System
IRQ 310	Microsoft ACPI-Compliant System
IRQ 311	Microsoft ACPI-Compliant System
IRQ 312	Microsoft ACPI-Compliant System
IRQ 313	Microsoft ACPI-Compliant System
IRQ 314	Microsoft ACPI-Compliant System
IRQ 315	Microsoft ACPI-Compliant System
IRQ 316	Microsoft ACPI-Compliant System
IRQ 317	Microsoft ACPI-Compliant System
IRQ 318	Microsoft ACPI-Compliant System
IRQ 319	Microsoft ACPI-Compliant System
IRQ 320	Microsoft ACPI-Compliant System
IRQ 321	Microsoft ACPI-Compliant System
IRQ 322	Microsoft ACPI-Compliant System
IRQ 323	Microsoft ACPI-Compliant System
IRQ 324	Microsoft ACPI-Compliant System
IRQ 325	Microsoft ACPI-Compliant System
IRQ 326	Microsoft ACPI-Compliant System
IRQ 327	Microsoft ACPI-Compliant System
IRQ 328	Microsoft ACPI-Compliant System
IRQ 329	Microsoft ACPI-Compliant System
IRQ 330	Microsoft ACPI-Compliant System
IRQ 331	Microsoft ACPI-Compliant System
IRQ 332	Microsoft ACPI-Compliant System
IRQ 333	Microsoft ACPI-Compliant System

IRQ	Assignment
IRQ 334	Microsoft ACPI-Compliant System
IRQ 335	Microsoft ACPI-Compliant System
IRQ 336	Microsoft ACPI-Compliant System
IRQ 337	Microsoft ACPI-Compliant System
IRQ 338	Microsoft ACPI-Compliant System
IRQ 339	Microsoft ACPI-Compliant System
IRQ 340	Microsoft ACPI-Compliant System
IRQ 341	Microsoft ACPI-Compliant System
IRQ 342	Microsoft ACPI-Compliant System
IRQ 343	Microsoft ACPI-Compliant System
IRQ 344	Microsoft ACPI-Compliant System
IRQ 345	Microsoft ACPI-Compliant System
IRQ 346	Microsoft ACPI-Compliant System
IRQ 347	Microsoft ACPI-Compliant System
IRQ 348	Microsoft ACPI-Compliant System
IRQ 349	Microsoft ACPI-Compliant System
IRQ 350	Microsoft ACPI-Compliant System
IRQ 351	Microsoft ACPI-Compliant System
IRQ 352	Microsoft ACPI-Compliant System
IRQ 353	Microsoft ACPI-Compliant System
IRQ 354	Microsoft ACPI-Compliant System
IRQ 355	Microsoft ACPI-Compliant System
IRQ 356	Microsoft ACPI-Compliant System
IRQ 357	Microsoft ACPI-Compliant System
IRQ 358	Microsoft ACPI-Compliant System
IRQ 359	Microsoft ACPI-Compliant System
IRQ 360	Microsoft ACPI-Compliant System
IRQ 361	Microsoft ACPI-Compliant System
IRQ 362	Microsoft ACPI-Compliant System
IRQ 363	Microsoft ACPI-Compliant System
IRQ 364	Microsoft ACPI-Compliant System
IRQ 365	Microsoft ACPI-Compliant System
IRQ 366	Microsoft ACPI-Compliant System
IRQ 367	Microsoft ACPI-Compliant System
IRQ 368	Microsoft ACPI-Compliant System
IRQ 369	Microsoft ACPI-Compliant System
IRQ 370	Microsoft ACPI-Compliant System
IRQ 371	Microsoft ACPI-Compliant System
IRQ 372	Microsoft ACPI-Compliant System
IRQ 373	Microsoft ACPI-Compliant System

IRQ	Assignment
IRQ 374	Microsoft ACPI-Compliant System
IRQ 375	Microsoft ACPI-Compliant System
IRQ 376	Microsoft ACPI-Compliant System
IRQ 377	Microsoft ACPI-Compliant System
IRQ 378	Microsoft ACPI-Compliant System
IRQ 379	Microsoft ACPI-Compliant System
IRQ 380	Microsoft ACPI-Compliant System
IRQ 381	Microsoft ACPI-Compliant System
IRQ 382	Microsoft ACPI-Compliant System
IRQ 383	Microsoft ACPI-Compliant System
IRQ 384	Microsoft ACPI-Compliant System
IRQ 385	Microsoft ACPI-Compliant System
IRQ 386	Microsoft ACPI-Compliant System
IRQ 387	Microsoft ACPI-Compliant System
IRQ 388	Microsoft ACPI-Compliant System
IRQ 389	Microsoft ACPI-Compliant System
IRQ 390	Microsoft ACPI-Compliant System
IRQ 391	Microsoft ACPI-Compliant System
IRQ 392	Microsoft ACPI-Compliant System
IRQ 393	Microsoft ACPI-Compliant System
IRQ 394	Microsoft ACPI-Compliant System
IRQ 395	Microsoft ACPI-Compliant System
IRQ 396	Microsoft ACPI-Compliant System
IRQ 397	Microsoft ACPI-Compliant System
IRQ 398	Microsoft ACPI-Compliant System
IRQ 399	Microsoft ACPI-Compliant System
IRQ 400	Microsoft ACPI-Compliant System
IRQ 401	Microsoft ACPI-Compliant System
IRQ 402	Microsoft ACPI-Compliant System
IRQ 403	Microsoft ACPI-Compliant System
IRQ 404	Microsoft ACPI-Compliant System
IRQ 405	Microsoft ACPI-Compliant System
IRQ 406	Microsoft ACPI-Compliant System
IRQ 407	Microsoft ACPI-Compliant System
IRQ 408	Microsoft ACPI-Compliant System
IRQ 409	Microsoft ACPI-Compliant System
IRQ 410	Microsoft ACPI-Compliant System
IRQ 411	Microsoft ACPI-Compliant System
IRQ 412	Microsoft ACPI-Compliant System
IRQ 413	Microsoft ACPI-Compliant System

IRQ	Assignment
IRQ 414	Microsoft ACPI-Compliant System
IRQ 415	Microsoft ACPI-Compliant System
IRQ 416	Microsoft ACPI-Compliant System
IRQ 417	Microsoft ACPI-Compliant System
IRQ 418	Microsoft ACPI-Compliant System
IRQ 419	Microsoft ACPI-Compliant System
IRQ 420	Microsoft ACPI-Compliant System
IRQ 421	Microsoft ACPI-Compliant System
IRQ 422	Microsoft ACPI-Compliant System
IRQ 423	Microsoft ACPI-Compliant System
IRQ 424	Microsoft ACPI-Compliant System
IRQ 425	Microsoft ACPI-Compliant System
IRQ 426	Microsoft ACPI-Compliant System
IRQ 427	Microsoft ACPI-Compliant System
IRQ 428	Microsoft ACPI-Compliant System
IRQ 429	Microsoft ACPI-Compliant System
IRQ 430	Microsoft ACPI-Compliant System
IRQ 431	Microsoft ACPI-Compliant System
IRQ 432	Microsoft ACPI-Compliant System
IRQ 433	Microsoft ACPI-Compliant System
IRQ 434	Microsoft ACPI-Compliant System
IRQ 435	Microsoft ACPI-Compliant System
IRQ 436	Microsoft ACPI-Compliant System
IRQ 437	Microsoft ACPI-Compliant System
IRQ 438	Microsoft ACPI-Compliant System
IRQ 439	Microsoft ACPI-Compliant System
IRQ 440	Microsoft ACPI-Compliant System
IRQ 441	Microsoft ACPI-Compliant System
IRQ 442	Microsoft ACPI-Compliant System
IRQ 443	Microsoft ACPI-Compliant System
IRQ 444	Microsoft ACPI-Compliant System
IRQ 445	Microsoft ACPI-Compliant System
IRQ 446	Microsoft ACPI-Compliant System
IRQ 447	Microsoft ACPI-Compliant System
IRQ 448	Microsoft ACPI-Compliant System
IRQ 449	Microsoft ACPI-Compliant System
IRQ 450	Microsoft ACPI-Compliant System
IRQ 451	Microsoft ACPI-Compliant System
IRQ 452	Microsoft ACPI-Compliant System
IRQ 453	Microsoft ACPI-Compliant System

IRQ	Assignment
IRQ 454	Microsoft ACPI-Compliant System
IRQ 455	Microsoft ACPI-Compliant System
IRQ 456	Microsoft ACPI-Compliant System
IRQ 457	Microsoft ACPI-Compliant System
IRQ 458	Microsoft ACPI-Compliant System
IRQ 459	Microsoft ACPI-Compliant System
IRQ 460	Microsoft ACPI-Compliant System
IRQ 461	Microsoft ACPI-Compliant System
IRQ 462	Microsoft ACPI-Compliant System
IRQ 463	Microsoft ACPI-Compliant System
IRQ 464	Microsoft ACPI-Compliant System
IRQ 465	Microsoft ACPI-Compliant System
IRQ 466	Microsoft ACPI-Compliant System
IRQ 467	Microsoft ACPI-Compliant System
IRQ 468	Microsoft ACPI-Compliant System
IRQ 469	Microsoft ACPI-Compliant System
IRQ 470	Microsoft ACPI-Compliant System
IRQ 471	Microsoft ACPI-Compliant System
IRQ 472	Microsoft ACPI-Compliant System
IRQ 473	Microsoft ACPI-Compliant System
IRQ 474	Microsoft ACPI-Compliant System
IRQ 475	Microsoft ACPI-Compliant System
IRQ 476	Microsoft ACPI-Compliant System
IRQ 477	Microsoft ACPI-Compliant System
IRQ 478	Microsoft ACPI-Compliant System
IRQ 479	Microsoft ACPI-Compliant System
IRQ 480	Microsoft ACPI-Compliant System
IRQ 481	Microsoft ACPI-Compliant System
IRQ 482	Microsoft ACPI-Compliant System
IRQ 483	Microsoft ACPI-Compliant System
IRQ 484	Microsoft ACPI-Compliant System
IRQ 485	Microsoft ACPI-Compliant System
IRQ 486	Microsoft ACPI-Compliant System
IRQ 487	Microsoft ACPI-Compliant System
IRQ 488	Microsoft ACPI-Compliant System
IRQ 489	Microsoft ACPI-Compliant System
IRQ 490	Microsoft ACPI-Compliant System
IRQ 491	Microsoft ACPI-Compliant System
IRQ 492	Microsoft ACPI-Compliant System
IRQ 493	Microsoft ACPI-Compliant System

IRQ	Assignment
IRQ 494	Microsoft ACPI-Compliant System
IRQ 495	Microsoft ACPI-Compliant System
IRQ 496	Microsoft ACPI-Compliant System
IRQ 497	Microsoft ACPI-Compliant System
IRQ 498	Microsoft ACPI-Compliant System
IRQ 499	Microsoft ACPI-Compliant System
IRQ 500	Microsoft ACPI-Compliant System
IRQ 501	Microsoft ACPI-Compliant System
IRQ 502	Microsoft ACPI-Compliant System
IRQ 503	Microsoft ACPI-Compliant System
IRQ 504	Microsoft ACPI-Compliant System
IRQ 505	Microsoft ACPI-Compliant System
IRQ 506	Microsoft ACPI-Compliant System
IRQ 507	Microsoft ACPI-Compliant System
IRQ 508	Microsoft ACPI-Compliant System
IRQ 509	Microsoft ACPI-Compliant System
IRQ 510	Microsoft ACPI-Compliant System
IRQ 511	Microsoft ACPI-Compliant System
IRQ 4294967277	Intel(R) I210 Gigabit Network Connection #2
IRQ 4294967278	Intel(R) I210 Gigabit Network Connection #2
IRQ 4294967279	Intel(R) I210 Gigabit Network Connection #2
IRQ 4294967280	Intel(R) I210 Gigabit Network Connection #2
IRQ 4294967281	Intel(R) I210 Gigabit Network Connection #2
IRQ 4294967282	Intel(R) I210 Gigabit Network Connection #2
IRQ 4294967283	Intel(R) I210 Gigabit Network Connection
IRQ 4294967284	Intel(R) I210 Gigabit Network Connection
IRQ 4294967285	Intel(R) I210 Gigabit Network Connection
IRQ 4294967286	Intel(R) I210 Gigabit Network Connection
IRQ 4294967287	Intel(R) I210 Gigabit Network Connection
IRQ 4294967288	Intel(R) I210 Gigabit Network Connection
IRQ 4294967289	Intel(R) USB 3.0 eXtensible Host Controller - 1.0 (Microsoft)
IRQ 4294967290	Intel(R) Trusted Execution Engine Interface
IRQ 4294967291	Intel(R) HD Graphics
IRQ 4294967292	Standard SATA AHCI Controller
IRQ 4294967293	Intel(R) Celeron(R)/Pentium(R) Processor PCI Express Root Port - 5AD9
IRQ 4294967294	Intel(R) Celeron(R)/Pentium(R) Processor PCI Express Root Port - 5AD8

Note: These resource information were gathered using Windows 10 (the IRQ could be assigned differently depending on OS).

I/O MAP

I/O Map	Assignment
0x00000000-0x0000006F	PCI Express Root Complex
0x00000020-0x00000021	Programmable interrupt controller
0x00000024-0x00000025	Programmable interrupt controller
0x00000028-0x00000029	Programmable interrupt controller
0x0000002C-0x0000002D	Programmable interrupt controller
0x0000002E-0x0000002F	Motherboard resources
0x00000030-0x00000031	Programmable interrupt controller
0x00000034-0x00000035	Programmable interrupt controller
0x00000038-0x00000039	Programmable interrupt controller
0x0000003C-0x0000003D	Programmable interrupt controller
0x00000040-0x00000043	System timer
0x0000004E-0x0000004F	Motherboard resources
0x00000050-0x00000053	System timer
0x00000061-0x00000061	Motherboard resources
0x00000063-0x00000063	Motherboard resources
0x00000065-0x00000065	Motherboard resources
0x00000067-0x00000067	Motherboard resources
0x00000070-0x00000070	Motherboard resources
0x00000070-0x00000070	System CMOS/real time clock
0x00000078-0x000000CF7	PCI Express Root Complex
0x00000080-0x0000008F	Motherboard resources
0x00000092-0x00000092	Motherboard resources
0x000000A0-0x000000A1	Programmable interrupt controller
0x000000A4-0x000000A5	Programmable interrupt controller
0x000000A8-0x000000A9	Programmable interrupt controller
0x000000AC-0x000000AD	Programmable interrupt controller
0x000000B0-0x000000B1	Programmable interrupt controller
0x000000B2-0x000000B3	Motherboard resources
0x000000B4-0x000000B5	Programmable interrupt controller
0x000000B8-0x000000B9	Programmable interrupt controller
0x000000BC-0x000000BD	Programmable interrupt controller
0x000002E8-0x000002EF	Communications Port (COM4)
0x000002F8-0x000002FF	Communications Port (COM2)
0x000003E8-0x000003EF	Communications Port (COM3)
0x000003F8-0x000003FF	Communications Port (COM1)
0x00000400-0x0000047F	Motherboard resources
0x000004D0-0x000004D1	Programmable interrupt controller

I/O Map	Assignment
0x00000500-0x000005FE	Motherboard resources
0x00000600-0x0000061F	Motherboard resources
0x00000680-0x0000069F	Motherboard resources
0x00000A00-0x00000A0F	Motherboard resources
0x00000A10-0x00000A1F	Motherboard resources
0x00000A20-0x00000A2F	Motherboard resources
0x00000D00-0x0000FFFF	PCI Express Root Complex
0x0000164E-0x0000164F	Motherboard resources
0x0000D000-0x0000DFFF	Intel(R) Celeron(R)/Pentium(R) Processor PCI Express Root Port - 5AD9
0x0000E000-0x0000EFFF	Intel(R) Celeron(R)/Pentium(R) Processor PCI Express Root Port - 5AD8
0x0000F000-0x0000F03F	Intel(R) HD Graphics
0x0000F040-0x0000F05F	Intel(R) Celeron(R)/Pentium(R) Processor SMBUS - 5AD4
0x0000F060-0x0000F07F	Standard SATA AHCI Controller
0x0000F080-0x0000F083	Standard SATA AHCI Controller
0x0000F090-0x0000F097	Standard SATA AHCI Controller

Memory Map

Memory Map	Assignment
0xE0000000-0xEFFFFFFF	Motherboard resources
0xE0000000-0xEFFFFFFF	PCI Express Root Complex
0xFE000000-0xFEFFFFFF	Motherboard resources
0xFED01000-0xFED01FFF	Motherboard resources
0xFED03000-0xFED03FFF	Motherboard resources
0xFED06000-0xFED06FFF	Motherboard resources
0xFED08000-0xFED09FFF	Motherboard resources
0xFED80000-0xFEDBFFFF	Motherboard resources
0xFED1C000-0xFED1CFFF	Motherboard resources
0xFEE00000-0xFEEFFFFFFF	Motherboard resources
0x91310000-0x91313FFF	High Definition Audio Controller
0x91000000-0x910FFFFFFF	High Definition Audio Controller
0x91316000-0x913160FF	Intel(R) Celeron(R)/Pentium(R) Processor SMBUS - 5AD4
0x91100000-0x911FFFFFFF	Intel(R) Celeron(R)/Pentium(R) Processor PCI Express Root Port - 5AD9
0x91280000-0x912FFFFFFF	Intel(R) I210 Gigabit Network Connection #2
0x9127C000-0x91277FFF	Intel(R) I210 Gigabit Network Connection #2

Memory Map	Assignment
0x91180000-0x911FFFFFFF	Intel(R) I210 Gigabit Network Connection
0x9117C000-0x9117FFFFFFF	Intel(R) I210 Gigabit Network Connection
0xFED00000-0xFED003FF	High precision event timer
0x91318000-0x91318FFF	Intel(R) Serial IO I2C Host Controller - 5AAC
0x91317000-0x91317FFF	Intel(R) Serial IO I2C Host Controller - 5AAC
0x91300000-0x9130FFFF	Intel(R) USB 3.0 eXtensible Host Controller - 1.0 (Microsoft)
0x91200000-0x912FFFFFFF	Intel(R) Celeron(R)/Pentium(R) Processor PCI Express Root Port - 5AD8
0x80000000-0x8FFFFFFF	PCI Express Root Complex
0x90000000-0x90FFFFFFF	Intel(R) HD Graphics
0x9131D000-0x9131DFFF	Intel(R) Trusted Execution Engine Interface
0x80000000-0x8FFFFFFF	Intel(R) HD Graphics
0x91314000-0x91315FFF	Standard SATA AHCI Controller
0x9131A000-0x9131A0FF	Standard SATA AHCI Controller
0x91319000-0x913197FF	Standard SATA AHCI Controller
0x7B800001-0x7BFFFFFFF	PCI Express Root Complex
0x7C000001-0x7CFFFFFFF	PCI Express Root Complex

Configuring WatchDog Timer

The I/O port address of the watchdog timer is 2E (hex) and 2F (hex). 2E (hex) is the address port. 2F (hex) is the data port. User must first assign the address of register by writing address value into address port 2E (hex), then write/read data to/from the assigned register through data port 2F (hex).

Configuration Sequence

To program F81846 configuration registers, the following configuration sequence must be followed:

(1) Enter the extended function mode

To place the chip into the Extended Function Mode, two successive writes of 0x87 must be applied to Extended Function Enable Registers (EFERs, i.e. 2Eh or 4Eh).

(2) Configure the configuration registers

The chip selects the Logical Device and activates the desired Logical Devices through Extended Function Index Register (EFIR) and Extended Function Data Register (EFDR). The EFIR is located at the same address as the EFER, and the EFDR is located at address (EFIR+1). First, write the Logical Device Number (i.e. 0x07) to the EFIR and then write the number of the desired Logical Device to the EFDR. If accessing the Chip (Global) Control Registers, this step is not required. Secondly, write the address of the desired configuration register within the Logical Device to the EFIR and then write (or read) the desired configuration register through the EFDR.

(3) Exit the extended function mode

To exit the Extended Function Mode, writing 0xAA to the EFER is required. Once the chip exits the Extended Function Mode, it is in the normal running mode and is ready to enter the configuration mode.

Code example for watch dog timer

Enable the watchdog timer and set the timeout interval to **30** seconds.

```

;----- Enter extended function mode -----
mov     dx, 2Eh
mov     al, 87h
out     dx, al
out     dx, al
;----- Select Logical Device 7 of watchdog timer -----
mov     al, 07h
out     dx, al
inc     dx
mov     al, 07h
out     dx, al
;----- Enable Watch dog feature -----
dec     dx
mov     al, 30h
out     dx, al
inc     dx
mov     al, 01h
out     dx, al
;----- Set timeout interval as 30seconds and start counting -----
dec     dx
mov     al, F6h
out     dx, al
inc     dx
mov     al, 1Eh
out     dx, al
;----- Enable Watch PME-----
dec     dx
mov     al, FAh
out     dx, al
inc     dx
in      al, dx
or      al, 51h
out     dx, al
;----- Set second as counting unit -----
dec     dx
mov     al, F5h
out     dx, al
inc     dx
in      al, dx
and     al, DEh
out     dx, al
;----- Start the watchdog timer -----
or      al, 20h
out     dx, al
;----- Exit the extended function mode -----
dec     dx
mov     al, AAh
out     dx, al

```

Flash BIOS Update

I. Prerequisites

- 1** Prepare a bootable media (e.g. USB storage device) which can boot the system to EFI Shell.
- 2** Download and save the BIOS file (e.g. E0980PM1.bin) to the bootable device.
- 3** Copy AMI flash utility – AfuEfix64.efi (v5.08.02.1189) into the bootable device.
- 4** Make sure the target system can first boot to the bootable device.
 - (1) Connect the bootable USB device.
 - (2) Turn on the computer and press <ESC> or during boot to enter BIOS Setup.
 - (3) The system will go into the BIOS setup menu.
 - (4) Select [**Boot**] menu.
 - (5) Set the USB bootable device as the 1st boot device.
 - (6) Press <F4> key to save the configuration and exit the BIOS setup menu.

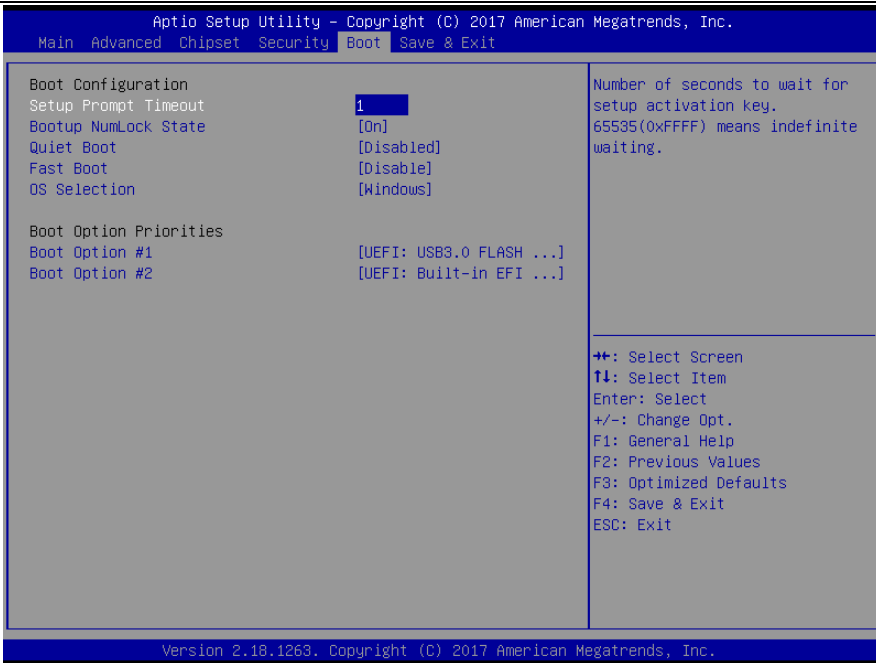

II. AFUDOS Command for System BIOS Update

AFUEFI command for system BIOS update

AfuEfix64.efi is the AMI firmware update utility. The command line is shown as below:

AfuEfix64 <ROM File Name> [option1] [option2]....

Users can type “**AfuEfix64/ ?**” to see all the definition of each control option. The recommended options for BIOS ROM update include the following parameters:

- /P:** Program main BIOS image.
- /B:** Program Boot Block.
- /N:** Program NVRAM.
- /X:** Don't check ROM ID.

III. BIOS Update Procedure

- 1 Use the bootable USB storage to boot up the system into the EFI Shell.
- 2 Type "**AfuEfix64 E098xxxx.bin /p /b /n /x**" and press enter to start the flash procedure.
(Note that xxxx means the BIOS revision part, e.g. 0PM1...)
- 3 During the update procedure, you will see the BIOS update process status and its percentage. Beware! Do not turn off the system power or reset your computer if the whole procedure is not complete yet, or it may crash the BIOS ROM and make the system unable to boot up next time.
- 4 After the BIOS update procedure is completed, the following messages will be shown:

```
fs0:\> AfuEfix64 E0980PM1.bin /p /b /n /x
+-----+
|          AMI Firmware Update Utility v5.08.02.1189          |
| Copyright (C)2016 American Megatrends Inc. All Rights Reserve. |
+-----+
Reading flash ..... done
- FFS checksums ..... ok
Erasing Boot Block ..... done
Updating Boot Block ..... done
Verifying Boot Block ..... done
Erasing Main Block ..... done
Updating Main Block ..... done
Verifying Main Block ..... done
Erasing NVRAM Block ..... done
Updating NVRAM Block ..... done
Verifying NVRAM Block ..... done

fs0:\>
```

- 5 Restart the system and boot up with the new BIOS configurations.
- 6 The BIOS Update is completed after the system is restarted.
- 7 Reboot the system and verify if the BIOS version shown on the initialization screen has been updated.

