

USER MANUAL

**KS-1330
32" Kitchen
Display System**

KS-1330 M1

KS-1330

32” Kitchen Display System

COPYRIGHT NOTICE & TRADEMARK

All trademarks and registered trademarks mentioned herein are the property of their respective owners.

This manual is copyrighted in August 2017. You may not reproduce or transmit in any form or by any means, electronic, or mechanical, including photocopying and recording.

DISCLAIMER

This user’s manual is meant to assist users in installing and setting up the system. The information contained in this document is subject to change without any notice.

CE NOTICE

This is a class A product. In a domestic environment this product may cause radio interference in which case the user may be required to take adequate measures.

FCC NOTICE

This equipment has been tested and found to comply with the limits for a Class A digital device, pursuant to part 15 of the FCC Rules. These limits are designed to provide reasonable protection against harmful interference when the equipment is operated in a commercial environment. This equipment generates, uses, and can radiate radio frequency energy and, if not installed and used in accordance with the instruction manual, may cause harmful interference to radio communications. Operation of this equipment in a residential area is likely to cause harmful interference in which case the user will be required to correct the interference at his own expense.

You are cautioned that any change or modifications to the equipment not expressly approve by the party responsible for compliance could void your authority to operate such equipment.

	<p>CAUTION: Danger of explosion may occur when the battery is incorrectly replaced. Replace the battery only with the same or equivalent type recommended by the manufacturer. Dispose of used batteries according to the manufacturer's instructions.</p>
--	---

	<p>WARNING: Some internal parts of the system may have high electrical voltage. We strongly recommend that only qualified engineers are allowed to service and disassemble the system. If any damages should occur on the system and are caused by unauthorized servicing, it will not be covered by the product warranty. Please operate the LCD and Touchscreen with extra care as they can break easily.</p>
---	--

Contents

Revision History	vi
1 Introduction	1-1
1.1 About This Manual	1-2
2 Getting Started	2-1
2.1 Package List.....	2-2
2.2 System Overview	2-3
2.2.1 Front View	2-3
2.2.2 Rear View	2-3
2.2.3 Bottom View	2-4
2.2.4 Side View.....	2-4
2.2.5 Quarter View.....	2-4
2.3 System Specifications	2-5
2.4 Safety Precautions	2-6
3 System Configuration.....	3-1
3.1 External I/O Ports Diagram	3-2
3.1.1 Rear I/O Ports Diagram	3-2
3.2 Jumper & Connector Quick Reference Table.....	3-2
3.3 COMPONENT LOCATIONS	3-4
3.3.1 Jumper Settings.....	3-4
3.4 Setting Jumpers	3-6
3.5 Setting Main Board Connectors and Jumpers	3-8
3.5.1 LVDS Power Selection	3-8
3.5.2 Backlight Inverter PWM Voltage Selection	3-9

3.5.3	Power-On Mode Selection	3-10
3.5.4	Backlight Enable Selection.....	3-11
3.5.5	VGA/DVI Selection	3-12
3.5.6	LVDS Resolution Selection.....	3-13
3.5.7	COM3 PIN9 Definition Selection Guide	3-14
3.5.8	COM4 PIN9 Definition Selection Guide	3-14
3.5.9	Audio Port.....	3-15
3.5.10	Battery Wafer.....	3-16
3.5.11	COM Port.....	3-16
3.5.12	COM4 Connector.....	3-17
3.5.13	COM5 Connector.....	3-18
3.5.14	COM6 Connector.....	3-18
3.5.15	DVI-I & COM Port.....	3-19
3.5.16	Fan Connectors	3-20
3.5.17	DC 12V Connector	3-20
3.5.18	DIO Wafer.....	3-21
3.5.19	Front Panel Connector	3-21
3.5.20	Inverter Wafer	3-22
3.5.21	KB/MS Port.....	3-23
3.5.22	LAN & USB 2.0 Port	3-24
3.5.23	LAN& USB2.0/3.0 Port	3-25
3.5.24	LVDS Connector.....	3-26
3.5.25	SATA Connector	3-27
3.5.26	SATA Power Connector	3-27
3.5.27	USB Connector.....	3-28
3.5.28	MINI PCIE Connector	3-29
3.5.29	PCIE Bus	3-30
3.5.30	LPC Connector	3-31
3.5.31	Clear CMOS Data Selection.....	3-32

3.6	AD Board Jumper & Connector Quick Reference Table	3-33
3.7	AD BOARD COMPONENT LOCATIONS	3-34
3.7.1	Top View of KS-1330 AD Board	3-34
3.8	Setting AD Board Connectors	3-35
3.8.1	Audio Line-in Jack	3-35
3.8.2	DVI Connector	3-35
3.8.3	Panel B+ 3.3V / 5V / 12V Selection.....	3-36
3.8.4	PWM / Analog Selection	3-36
3.8.5	LCD Panel for LVDS Connector	3-37
3.8.6	Key Pad Connector	3-38
3.8.7	Inverter Connector.....	3-38
3.8.8	UART Connector	3-39
3.8.9	IR Connector	3-39
3.8.10	Ext. Amp. Connector.....	3-39
4	Software Utilities	4-1
4.1	Introduction.....	4-2
4.2	Installing Intel® Chipset Software Installation Utility	4-3
4.2.1	Introduction.....	4-3
4.2.2	Intel® Chipset Software Installation Utility.....	4-3
4.3	Intel® Trusted Execution Engine Installation Utility	4-4
4.4	Intel® USB 3.0 eXtensible Host Controller Utility	4-5
4.5	Installing Graphics Driver Utility	4-6
4.6	Installing LAN Driver Utility.....	4-7
4.7	Installing Sound Driver Utility	4-8
5	BIOS SETUP	5-1

5.1	Introduction.....	5-2
5.2	Accessing Setup Utility.....	5-3
5.3	Main.....	5-7
5.4	Advanced	5-9
5.4.1	Advanced – ACPI Settings	5-10
5.4.2	Advanced – F81866 Super IO Configuration	5-11
5.4.3	Advanced – Hardware Monitor	5-18
5.4.4	Advanced – F81866 Watchdog Configuration.....	5-19
5.4.5	Advanced – CPU Configuration	5-20
5.4.6	Advanced – IDE Configuration	5-22
5.4.7	Advanced – CSM Configuration	5-23
5.4.8	Advanced – USB Configuration.....	5-25
5.5	Chipset	5-27
5.5.1	Chipset – North Bridge	5-28
5.5.2	Chipset – South Bridge.....	5-30
5.6	Security	5-34
5.7	Boot	5-36
5.8	Save & Exit.....	5-39

Appendix A System Diagrams 1

KS-1330 System Exploded Diagram	2
KS-1330 Front Cover Exploded Diagram	4
KS-1330 PCB Unit Exploded Diagram	6
KS-1330 Heatsink Unit Exploded Diagram.....	7
KS-1330 Power Unit Exploded Diagram.....	8
KS-1330 HDD Exploded Diagram.....	9
KS-1330 I/O Exploded Diagram.....	10

Appendix B Technical Summary	1
System Block Diagram	2
Interrupt Map	3
I/O MAP	9
Memory Map	12
Configuring WatchDog Timer.....	14
Flash BIOS Update	17

List of Figures

Figure 3-1. Main Board Component Location (Top View)	3-4
Figure 3-2. AD Board Component Location (Top View)	3-34
Figure 5-1. Extensible Firmware Interface Diagram	5-2
Figure 5-2. POST Screen with AMI Logo.....	5-4

Revision History

The revision history of KS-1330 User Manual is described below:

Version No.	Revision History	Page No.	Date
M1	Initial Release	-	2017/08/10

1

Introduction

This chapter provides the introduction for the KS-1330 system as well as the framework of the user manual.

The following topic is included:

- About This Manual

1.1 About This Manual

Thank you for purchasing our KS-1330 system. The KS-1330 is an updated system designed to be comparable with the highest performance of IBM AT personal computers. The KS-1330 provides faster processing speed, greater expandability and can handle more tasks than before. This manual is designed to assist you how to install and set up the whole system. It contains 5 chapters and 2 appendixes. Users can configure the system according to their own needs. This user manual is intended for service personnel with strong hardware background. It is not intended for general users.

The following section outlines the structure of this user manual.

Chapter 1 Introduction

This chapter introduces you to the background of this manual.

Chapter 2 Getting Started

This chapter describes the package contents and outlines the system specifications. It also includes the physical illustrations for the KS-1330 system. Read the safety reminders carefully on how to take care of your system properly.

Chapter 3 System Configuration

This chapter outlines the locations of the motherboard components and their respective functions. You will learn how to set the jumpers and configure the system to meet your own needs.

Chapter 4 Software Utilities

This chapter contains helpful information for proper installations of the Intel Chipset Software Installation Utility, Intel Management Engine Components Installer Driver Utility, Intel USB 3.0 Extensible Host Controller Driver Utility, RAID Driver Utility (optional, only for Q170 SKU), Graphics Driver Utility, LAN Driver Utility and Sound Driver Utility.

Chapter 5 AMI BIOS Setup

This chapter indicates you how to change the BIOS configurations.

Appendix A System Assembly Diagrams

This appendix provides the system exploded diagrams and part numbers of KS-1330.

Appendix B Technical Summary

This appendix provides the information about the system block diagram, allocation maps for system resources, Watchdog Timer Configuration and Flash BIOS Update.

2 Getting Started

This chapter provides the information for the KS-1330 system. It describes how to set up the system quickly and outlines the system specifications.

The following topics are included:

- Package List
- System Overview
- System Diagrams
- System Specification
- Safety Precautions

Experienced users can go to Chapter 3 System Configuration on page 3-1 for a quick start.

2.1 Package List

If you discover any of the items listed below are damaged or lost, please contact your local distributor immediately.

Item	Q'ty
KS-1330	1
Manual / Driver DVD	1
Quick Guide	1
Mini Jumper (2 mm)	6
AC Power Cord	1

2.2 System Overview

Unit: mm

2.2.1 Front View

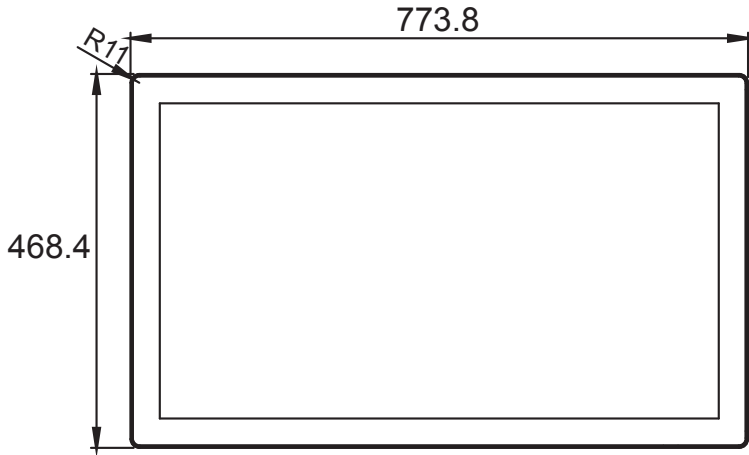

2.2.2 Rear View

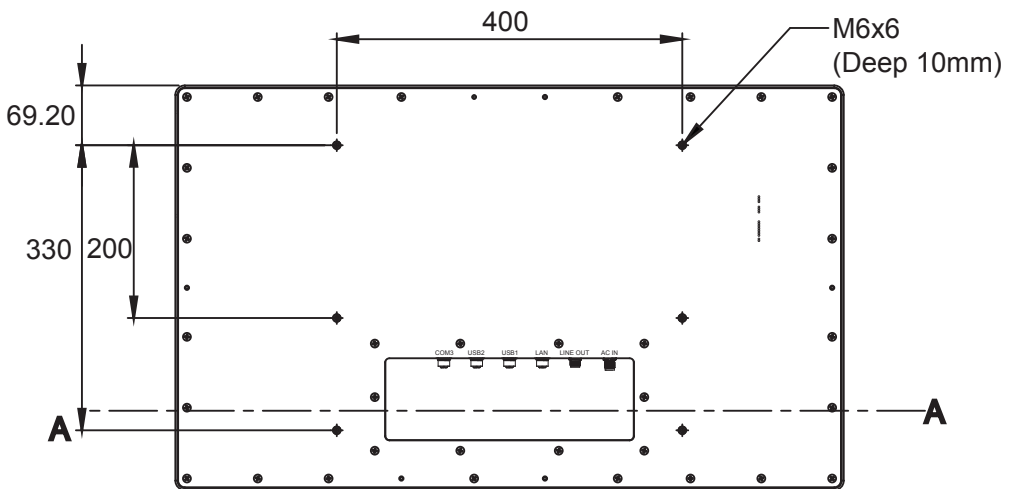

2.2.3 Bottom View

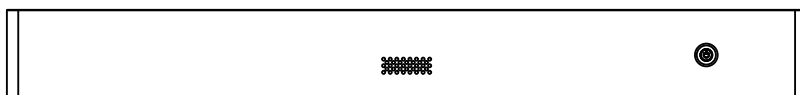

2.2.4 Side View

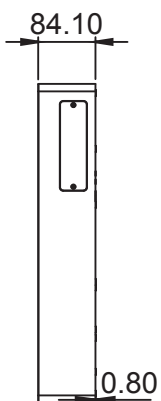

2.2.5 Quarter View

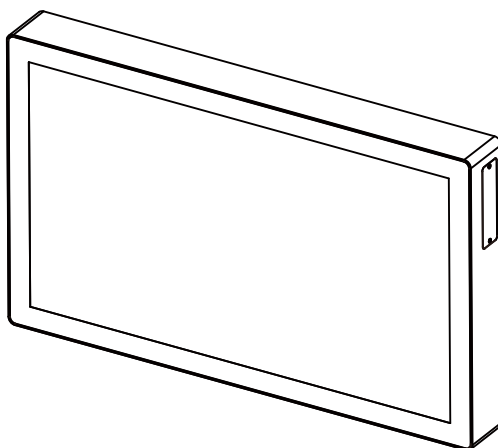

2.3 System Specifications

System	
CPU Support	➤ Intel® Bay Trail E3827 processor
Chipset	➤ Bay Trail SoC
Memory Support	➤ 1 x 4G DDR3L SO-DIMM
BIOS	➤ AMI SPI BIOS
Power Supply	➤ 164W Power inside
SATA Storage	➤ 1 x 2.5" SATA SSD
Watchdog Timer	➤ 1 ~ 255 seconds
Audio	➤ 2W speaker
LED Indicator	➤ 1 x Green Power LED
Buzzer	➤ Supports system beep
Waterproof function	➤ IP55
Operating System	➤ POSReady7 / Win 10 IoT LTSC 2016
System Weight	➤ 28 kg
Dimensions (W x H x D)	➤ 774 x 469 x 84 mm
Certificate	➤ FCC / CE
Rear I/O Ports	
LAN	1 x RJ45 (M12 waterproof connector)
USB	2 x USB 2.0 (M12 waterproof connector)
Serial Port	1 x DB9 (M12 waterproof connector)
Line Out	1 x Audio out (M12 waterproof connector)
Power Button	1 x wafer to PG9 connector
AC IN	1 x 100V/240V AC Input power connector (M12 waterproof connector)
Display	
Operating Display (LCD)	32" TFT-LCD (LED)
Touchscreen	32" Bezel-free projected capacitive touchscreen
Max. Resolution	1920 x 1080 dots
Brightness	Typical 500 cd/m2
Display Area	698.4(H) x 392.85(W)
Environment	
Operating Temperature	0°C ~ 40°C (32°F~ 104°F)
Storage Temperature	-5°C ~ 60°C (23°F~ 140°F)
Humidity	20%~ 85%

2.4 Safety Precautions

Before operating this system, read the following information carefully to protect your systems from damages, and extend the life cycle of the system.

1. Check the Line Voltage
 - The operating voltage for the power supply should be within the range of 100V to 240V AC; otherwise the system may be damaged.
2. Environmental Conditions
 - Place your KS-1330 on a sturdy, level surface. Be sure to allow enough space around the system to have easy access needs.
 - Avoid installing your KS-1330 system in extremely hot or cold places.
 - Avoid direct sunlight exposure for a long period of time (for example, in a closed car in summer time. Also avoid the system from any heating device.). Or do not use KS-1330 when it has been left outdoors in a cold winter day.
 - Avoid moving the system rapidly from a hot place to a cold place, and vice versa, because condensation may occur inside the system.
 - Protect your KS-1330 from strong vibrations which may cause hard disk failure.
 - Do not place the system too close to any radio-active device. Radio-active device may cause signal interference.
 - Always shut down the operating system before turning off the power.
3. Handling
 - Avoid placing heavy objects on the top of the system.
 - Do not turn the system upside down. This may cause the hard drive to malfunction.
 - Do not allow any objects to fall into this device.
 - If water or other liquid spills into the device, unplug the power cord immediately.
4. Good Care
 - When the outside case gets stained, remove the stains using neutral washing agent with a dry cloth.
 - Never use strong agents such as benzene and thinner to clean the surface of the case.
 - If heavy stains are present, moisten a cloth with diluted neutral washing agent or alcohol and then wipe thoroughly with a dry cloth.
 - If dust is accumulated on the case surface, remove it by using a special vacuum cleaner for computers.

3

System Configuration

This chapter contains helpful information about the external I/O Ports diagram, and jumper & connector settings, and component locations for the main board.

The following topics are included:

- External I/O Ports Diagram
- Main Board Jumper Settings and Component Locations
- How to Set Jumpers
- Setting Main Board Connectors and Jumpers

3.1 External I/O Ports Diagram

3.1.1 Rear I/O Ports Diagram

COM3 USB2 USB1 LAN LINE OUT AC IN



3.2 Jumper & Connector Quick Reference Table

JUMPER Description	NAME
COM3 Pin9 RI/5V/12V Selection	JP_COM3
COM4 Pin9 RI/5V/12V Selection	JP_COM4
Clear CMOS Data Selection	JP1
LVDS Power Selection	JP4
Backlight Power Selection	JP5
AT/ATX Mode Selection	JP7
Backlight Enable Selection	JP9
VGA/DVI Selection	JP10
LVDS Resolution Selection	JP14, JP15

CONNECTOR Description	NAME
Audio Port	JAUDIO1
Battery Wafer	JBAT1
COM Port	JCOM2_3
COM4 Connector	JCOM4
COM5 Connector	JCOM5
COM6 Connector	JCOM6
DVI-I & COM Port	JCOM_DVII1
FAN Connector	JCPU_FAN1, JSYS_FAN1
DC 12V Connector	JDC_PWR1
DIO Wafer	JDIO1
Front Connector	JFP1
Inverter Wafer	JINV1
KB/MS Port	JKB_MS1
LAN & USB2.0 Port	JLAN_USB1
LAN& USB2.0/3.0 Port	JLAN_USB2
LVDS Connector	JLVDS1
SATA Connector	JSATA1, JSATA2
SATA Power Connector	JSATA_PWR1, JSATA_PWR2
USB Connector	JUSB1

CONNECTOR Description	NAME
MINI PCIE Connector	M_PCI_E1
PCIE BUS	PCI_E1
LPC Connector	JLPC1

3.3 COMPONENT LOCATIONS

3.3.1 Jumper Settings

M/B: BM-0962

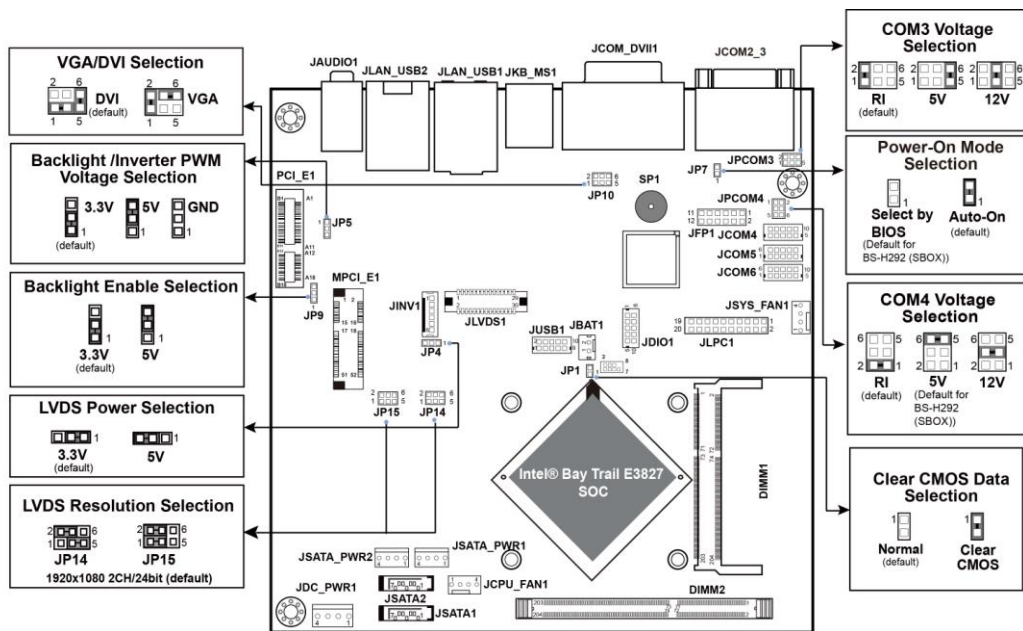

Figure 3-1. Main Board Component Location (Top View)

	<p>WARNING: Always disconnect the power cord when you are working with connectors and jumpers on the main board. Make sure both the system and peripheral devices are turned OFF as sudden surge of power could damage sensitive components. Make sure KS-1330 is properly grounded.</p>
	<p>CAUTION: Observe precautions while handling electrostatic sensitive components. Make sure to ground yourself to prevent static charge while you are working on the connectors and jumpers. Use a grounding wrist strap and place all electronic components in any static-shielded devices.</p>



CAUTION: Always touch the motherboard components by the edges. Never touch components such as a processor by its pins. Take special cares while you are holding electronic circuit boards by the edges only. Do not touch the mainboard components.

3.4 Setting Jumpers

You can configure your board by setting the jumpers. A jumper consists of two or three metal pins with a plastic base mounted on the card. By using a small plastic "cap", also known as the jumper cap (with a metal contact inside), you are able to connect the pins. So you can configure your hardware settings by "opening" or "closing" jumpers.

Jumpers can be combined into sets that are called jumper blocks. When jumpers are all in the block, you have to put them together to set up the hardware configuration. The figure below shows what this looks like.

Jumpers & Caps

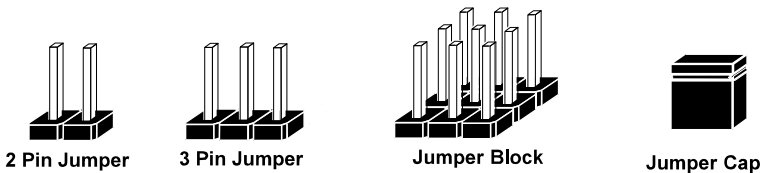

If a jumper has three pins, for example, labeled 1, 2 and 3. You can connect pins 1 and 2 to create one setting and shorting. You can also select to connect pins 2 and 3 to create another setting. The format of the jumper picture will be illustrated throughout this manual. The figure below shows different types of jumpers and jumper settings.

Jumper diagrams



Jumper Cap looks like this

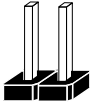

2 pin Jumper looks like this

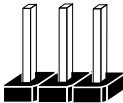

3 pin Jumper looks like this

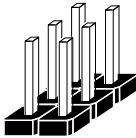
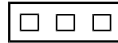

Jumper Block looks like this

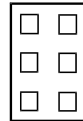

Jumper settings



2 pin Jumper closed(enabled)
looks like this



1

1

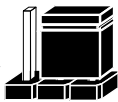

3 pin Jumper
2-3 pin closed(enabled)
looks like this



1

1



Jumper Block
1-2 pin closed(enabled)
looks like this

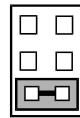

1 2

1 2

3.5 Setting Main Board Connectors and Jumpers



3.5.1 LVDS Power Selection

Jumper Name: JP4

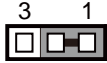
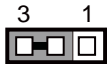
Description: LVDS Power Selection

SELECTION	JUMPTER SETTING	JUMPER ILLUSTRATION
3.3V	1-2 <i>(Default Setting)</i>	 JP4
5V	2-3	 JP4

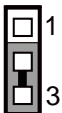

3.5.2 Backlight Inverter PWM Voltage Selection**Jumper Name: JP5****Description:** Backlight Inverter PWM Voltage Selection

SELECTION	JUMPTER SETTING	JUMPER ILLUSTRATION
3.3V	<i>1-2 (Default Setting)</i>	 JP5
5V	2-3	 JP5
GND	NC	 JP5

3.5.3 Power-On Mode Selection

Jumper Name: JP7



Description: Power-On Mode Selection

SELECTION	JUMPTER SETTING	JUMPER ILLUSTRATION
Auto-On	<i>1-2 (Default Setting)</i>	 JP7
Select by BIOS	NC	 JP7

Note 1: Manufacturing default for BS-H292 (SBOX) is "NC".

Note 2: **Auto-On** means that system will turn on automatically whenever the main power is restored.

3.5.4 Backlight Enable Selection**Jumper Name: JP9****Description:** Backlight Enable Selection

SELECTION	JUMPTER SETTING	JUMPER ILLUSTRATION
5V	2-3 <i>(Default Setting)</i>	 JP9
3.3V	1-2	 JP9

3.5.5 VGA/DVI Selection

Jumper Name: JP10

Description: VGA/DVI Selection

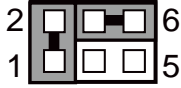
SELECTION	JUMPTER SETTING	JUMPER ILLUSTRATION
DVI	<p>1-3 5-6 <i>(Default Setting)</i></p>	 <p>JP10</p>
VGA	<p>1-2 4-6</p>	 <p>JP10</p>

3.5.6 LVDS Resolution Selection

Jumper Name: JP14 & JP15

Description: LVDS Resolution Selection

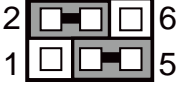
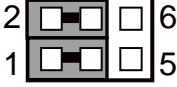
SELECTION	JUMPTER SETTING	JUMPER ILLUSTRATION	
<p>1920x1080 2CH/24bit</p>	<p><i>JP15(2-4)</i> <i>JP15(1-3)</i> <i>JP14(2-4)</i> <i>JP14(3-5)</i> <i>(Default Setting)</i></p>	 <p>JP14</p>	 <p>JP15</p>

3.5.7 COM3 PIN9 Definition Selection Guide

Jumper Name: JP_COM3

Description: COM3 Port pin9 RI/5V/12V Selection

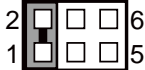
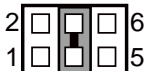
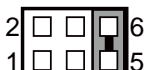

SELECTION	JUMPER SETTING	JUMPER ILLUSTRATION
RI	1-2	 <p>JP_COM3</p>
+12V	3-4 <i>(Default Setting)</i>	 <p>JP_COM3</p>
+5V	5-6	 <p>JP_COM3</p>

Note: Manufacturing default for BS-H292 (SBOX) is 5V (5-6).

3.5.8 COM4 PIN9 Definition Selection Guide

Jumper Name: JP_COM4

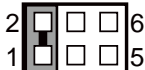
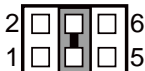
Description: COM4 Port pin9 RI/5V/12V Selection

SELECTION	JUMPER SETTING	JUMPER ILLUSTRATION
RI	1-2 <i>(Default Setting)</i>	 <p>JP_COM4</p>
+12V	3-4	 <p>JP_COM4</p>
+5V	5-6	 <p>JP_COM4</p>

Note: Manufacturing default for BS-H292 (SBOX) is 5V (5-6).

3.5.9 Audio Port

Port Name: JAUDIO1

Description: Line-In, Line-Out & Microphone
The connector can also support only Microphone.

Line-In:

PIN	ASSIGNMENT
32	LINE-IN-L
33	NC
34	NC
35	LINE-IN-R

Line-Out:

PIN	ASSIGNMENT
22	LINE-OUT-L
23	NC
24	NC
25	LINE-OUT-R

Mic-In:

PIN	ASSIGNMENT
1	GND
2	MIC_L
3	NC
4	NC
5	MIC_R

Others:

PIN	ASSIGNMENT
42	NC
43	NC
44	NC

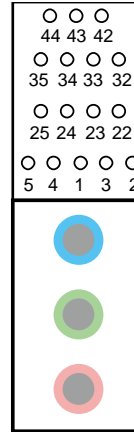

JAUDIO1

3.5.10 Battery Wafer

Connector Name: JBAT1

Description: Battery Wafer

PIN	ASSIGNMENT
1	RTC_BAT
2	GND

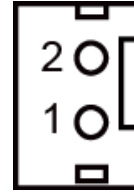

JBAT1

3.5.11 COM Port

Port Name: JCOM2_3

Description: COM2 and COM3 Ports

PIN	ASSIGNMENT
1	DCD
2	RXD
3	TXD
4	DTR
5	GND
6	DSR
7	RTS
8	CTS
9	RI

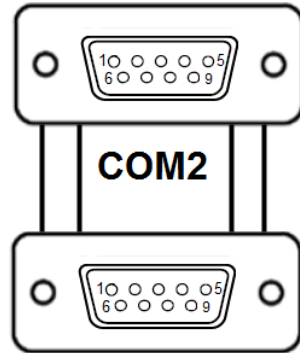

COM3

JCOM2_3

Note:

COM3 Pin 9 is selectable for RI, +5V or +12V by jumper setting. Default setting is 12V. Please see “COM3 PIN9 Definition Selection Guide” for selection details.

3.5.12 COM4 Connector

Connector Name: JCOM4

Description: COM4 Connector

PIN	ASSIGNMENT	PIN	ASSIGNMENT
1	DCD	6	DSR
2	RXD	7	RTS
3	TXD	8	CTS
4	DTR	9	RI
5	GND	10	NC

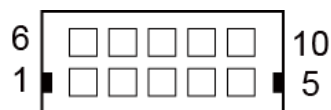

Note:

COM4 Pin 9 is selectable for RI, +5V or +12V by jumper setting. Default setting is RI. Please see “**COM4 PIN9 Definition Selection Guide**” for selection details.

3.5.13 COM5 Connector

Connector Name: JCOM5

Description: COM5 Connector

PIN	ASSIGNMENT	PIN	ASSIGNMENT
1	DCD	6	DSR
2	RXD	7	RTS
3	TXD	8	CTS
4	DTR	9	RI
5	GND	10	NC

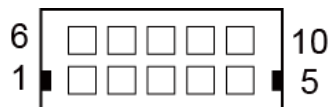

JCOM5

3.5.14 COM6 Connector

Connector Name: JCOM6

Description: COM6 Connector

PIN	ASSIGNMENT	PIN	ASSIGNMENT
1	DCD	6	DSR
2	RXD	7	RTS
3	TXD	8	CTS
4	DTR	9	RI
5	GND	10	NC

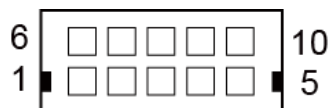

JCOM6

3.5.15 DVI-I & COM Port

Port Name: JCOM_DVII1

Description: DVI-I & COM Port

Connector Name: DVI-I

Description: DVI Connector

PIN	ASSIGNMENT	PIN	ASSIGNMENT
1	TMDS_D2-	2	TMDS_D2+
3	GND	4	NC
5	NC	6	DDC_CLK
7	DDC_DATA	8	VSYNC
9	TMDS_D1-	10	TMDS_D1+
11	GND	12	NC
13	NC	14	5V
15	GND	16	HPD
17	TMDS_D0-	18	TMDS_D0+
19	GND	20	NC
21	NC	22	GND
23	TMDS_CLK+	24	TMDS_CLK-
C1	RED	C2	GREEN
C3	BLUE	C4	HSYNC
C5	GND	-	-

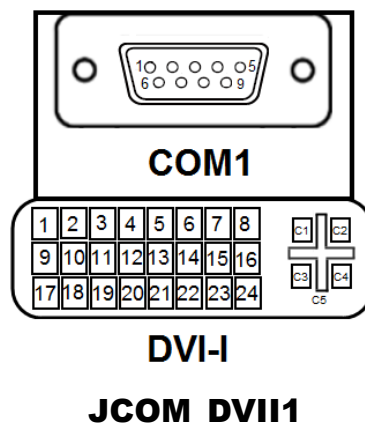

Connector Name: COM1

Description: COM Connector

PIN	ASSIGNMENT
1	DCD
2	RXD
3	TXD
4	DTR
5	GND
6	DSR
7	RTS
8	CTS
9	RI

3.5.16 Fan Connectors

Connector Name: JCPU_FAN1

Description: CPU Fan Connector

PIN	ASSIGNMENT
1	GND
2	12V
3	FAN_CONTROL
4	FAN_SIGNAL



JCPU_FAN1

Connector Name: JSYS_FAN1

Description: System Fan Connector

PIN	ASSIGNMENT
1	GND
2	12V
3	FAN_CONTROL
4	FAN_SIGNAL

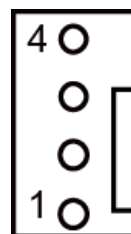

JSYS_FAN1

3.5.17 DC 12V Connector

Connector Name: JDC_PWR1

Description: DC 12V Connector

PIN	ASSIGNMENT
1	12V
2	12V
3	GND
4	GND



JDC_PWR1

3.5.18 DIO Wafer

Connector Name: JDIO1

Description: DIO Wafer

PIN	ASSIGNMENT	PIN	ASSIGNMENT
1	5V	2	GND
3	DIN0	4	DOUT0
5	DIN1	6	DOUT1
7	DIN2	8	DOUT2
9	DIN3	10	DOUT3

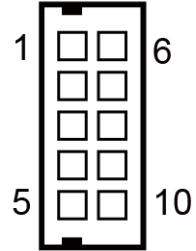

JDIO1

3.5.19 Front Panel Connector

Connector Name: JFP1

Description: Front Panel Connector

PIN	ASSIGNMENT	PIN	ASSIGNMENT
1	HDD_LED+	2	PWR_LED+
3	HDD_LED-	4	PWR_LED-
5	GND	6	SPK_VCC
7	RESET SWITCH	8	SPEAKER SIGNAL
9	POWER BUTTON	10	POWER BUTTON
11	GND	12	SPEAKER SIGNAL

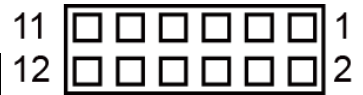

JFP1

3.5.20 Inverter Wafer

Connector Name: JINV1

Description: Inverter Wafer

PIN	ASSIGNMENT
1	12V
2	12V
3	GND
4	PWM SIGNAL
5	GND
6	BACKLIGHT EN



JINV1

3.5.21 KB/MS Port

Port Name: JKB_MS1

Description: KB/MS Port

Keyboard:

PIN	ASSIGNMENT
1	DATA
2	NC
3	GND
4	5V
5	CLK
6	NC

Mouse:

PIN	ASSIGNMENT
7	DATA
8	NC
9	GND
10	5V
11	CLK
12	NC

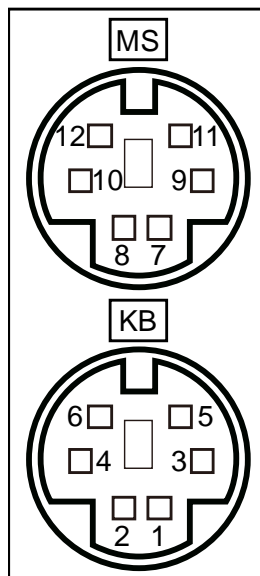

JKB_MS1

3.5.22 LAN & USB 2.0 Port

Port Name: JLAN_USB1

Description: LAN & USB2.0 Port

LAN:

PIN	ASSIGNMENT
1	TX_D1+
2	TX_D1-
3	RX_D2+
4	BI_D3+
5	BI_D3-
6	RX_D2-
7	BI_D4+
8	BI_D4-

USB2.0:

PIN	ASSIGNMENT
1	5V
2	D-
3	D+
4	GND

**Yellow Orange/
Green**

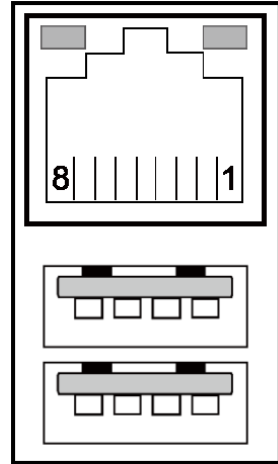

JLAN_USB1

3.5.23 LAN& USB2.0/3.0 Port

Port Name: JLAN_USB2

Description: LAN & USB2.0/3.0 Port

LAN:

PIN	ASSIGNMENT
1	TX_D1+
2	TX_D1-
3	RX_D2+
4	BI_D3+
5	BI_D3-
6	RX_D2-
7	BI_D4+
8	BI_D4-

USB2.0:

PIN	ASSIGNMENT
B1	VBUS
B2	D-
B3	D+
B4	GND
B5	STDA_SSRX-
B6	STDA_SSRX+
B7	GND
B8	STDA_SSTX-
B9	STDA_SSTX+

Yellow Orange/
Green

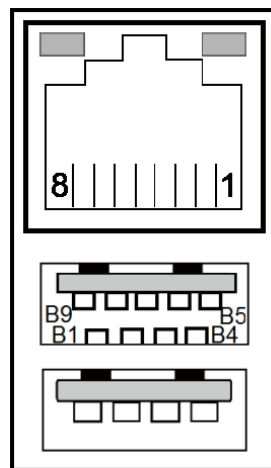

JLAN_USB2

3.5.24 LVDS Connector

Connector Name: JLVDS1

Description: LVDS Connector

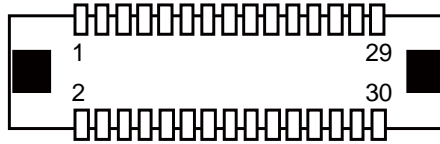

JLVDS1

PIN	ASSIGNMENT	PIN	ASSIGNMENT
1	LVDS_VCC	2	GND
3	LVDS1_CLK-	4	LVDS1_CLK+
5	GND	6	LVDS1_D2-
7	LVDS1_D2+	8	GND
9	LVDS1_D1-	10	LVDS1_D1+
11	LVDS1_D3+	12	LVDS1_D3-
13	LVDS1_D0+	14	LVDS1_D0-
15	GND	16	LVDS0_CLK+
17	LVDS0_CLK-	18	GND
19	LVDS0_D2+	20	LVDS0_D2-
21	GND	22	LVDS0_D1+
23	LVDS0_D1-	24	GND
25	LVDS0_D0+	26	LVDS0_D0-
27	LVDS0_D3+	28	LVDS0_D3-
29	LVDS_VCC	30	LVDS_VCC

3.5.25 SATA Connector

Connector Name: JSATA1, JSATA2

Description: Two Serial ATA Connectors

PIN	ASSIGNMENT
1	GND
2	TX+
3	TX-
4	GND
5	RX-
6	RX+
7	GND



**JSATA1/
JSATA2**

3.5.26 SATA Power Connector

Connector Name: JSATA_PWR1, JSATA_PWR2

Description: Two SATA Power Connectors

PIN	ASSIGNMENT
1	5V
2	GND
3	GND
4	12V

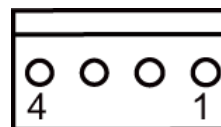

**JSATA_PWR1/
JSATA_PWR2**

3.5.27 USB Connector

Connector Name: JUSB1

Description: USB Connector

PIN	ASSIGNMENT	PIN	ASSIGNMENT
1	5V	2	5V
3	D-	4	D-
5	D+	6	D+
7	GND	8	GND
9	GND	10	GND

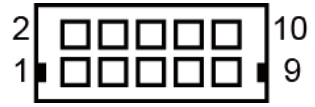

JUSB1

3.5.28 MINI PCIE Connector

Connector Location: M_PCI_E1

Description: MINI PCIE Connector

PIN	ASSIGNMENT	PIN	ASSIGNMENT
1	WAKE#	2	3.3V
3	NC	4	GND
5	NC	6	1.5V
7	CLKREQ#	8	NC
9	GND	10	NC
11	REFCLK-	12	NC
13	REFCLK+	14	NC
15	GND	16	NC
17	NC	18	GND
19	NC	20	NC
21	GND	22	PERST#
23	PERn0	24	3.3V
25	PERp0	26	GND
27	GND	28	1.5V
29	GND	30	SMB_CLK
31	PETn0	32	SMB_DATA
33	PETp0	34	GND
35	GND	36	USB_D-
37	GND	38	USB_D+
39	3.3V	40	GND
41	3.3V	42	NC
43	GND	44	NC
45	NC	46	NC
47	NC	48	1.5V
49	NC	50	GND
51	NC	52	3.3V

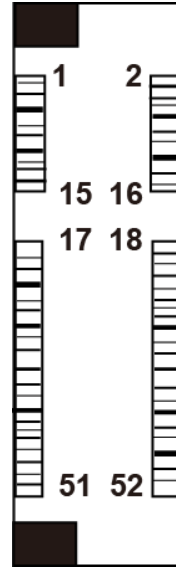

M_PCI_E1

3.5.29 PCIe Bus

Connector Location: PCI_E1

Description: PCIe Bus

PIN	ASSIGNMENT	PIN	ASSIGNMENT
A1	NC	B1	12V
A2	12V	B2	12V
A3	12V	B3	12V
A4	GND	B4	GND
A5	NC	B5	SMB_CLK
A6	NC	B6	SMB_DATA
A7	NC	B7	GND
A8	NC	B8	3.3V
A9	3.3V	B9	NC
A10	3.3V	B10	3.3V_SB
A11	PWRGD	B11	WAKE#
A12	GND	B12	NC
A13	REFCLK+	B13	GND
A14	REFCLK-	B14	HSOP0
A15	GND	B15	HSO0
A16	HSIP0	B16	GND
A17	HSIN0	B17	PRSNT#
A18	GND	B18	GND

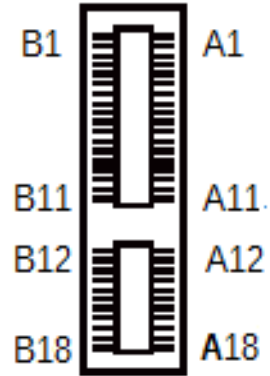

PCI_E1

3.5.30 LPC Connector

Connector Location: JLPC1

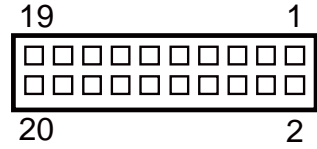

Description: LPC Connector

PIN	ASSIGNMENT	PIN	ASSIGNMENT
1	CLK	2	GND
3	FRAME	4	NC
5	RESET	6	VCC5
7	LAD3	8	LAD2
9	VCC3	10	LAD1
11	LAD0	12	GND
13	SMBCLK	14	SMBDATA
15	3VSB	16	SERIRQ
17	GND	18	CLK RUN
19	SUS_TAT	20	DREQ0

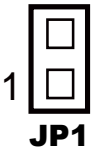

JLPC1

3.5.31 Clear CMOS Data Selection**Jumper Location: JP1****Description:** Clear CMOS Data Selection**Step 1.** Remove the main power of the PC.**Step 2.** Close **JP1** (pins 1-2) for 6 seconds by a cap.**Step 3.** Remove the cap which is just used on **JP1** (1-2), so that **JP1** returns to “OPEN”.**Step 4.** Power on the PC and the PC will then auto-reboot for once in order to set SoC’s register.**Step 5.** Done!

SELECTION	JUMPER SETTINGS	JUMPER ILLUSTRATION
Normal	<i>Open</i> (Default Setting)	
Clear CMOS Data	Close	

Note: Please make sure the main power is off before you clear CMOS.

3.6 AD Board Jumper & Connector Quick Reference Table

JUMPER Description	NAME
3.3V / 5V/ 12V Selection	JP1
PWM / Analog Selection	JP2

CONNECTOR Description	NAME
Audio Line-in Jack	CN3
DVI Connector	CN4
LCD Panel for LVDS Connector	J5
Key Pad Connector	J6
Inverter Connector	J7
UART Connector	J9
IR Connector	J11
Ext. Amp. Connector	J12

3.7 AD BOARD COMPONENT LOCATIONS

3.7.1 Top View of KS-1330 AD Board

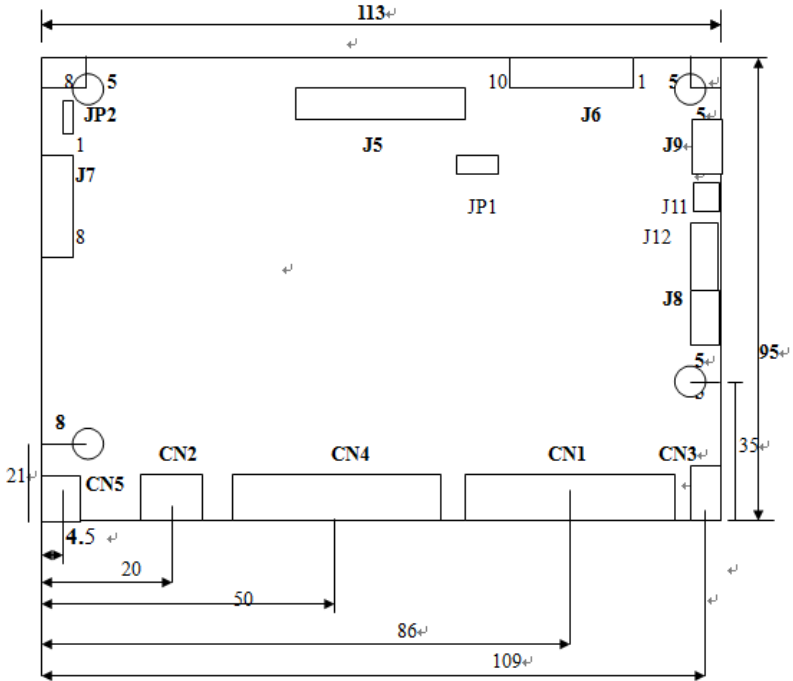

Figure 3-2. AD Board Component Location (Top View)

3.8 Setting AD Board Connectors

3.8.1 Audio Line-in Jack

Jumper Location: CN3

Description: Audio Line-in Jack

PIN	ASSIGNMENT
1	GND
2	L
3	NC
4	R
5	NC

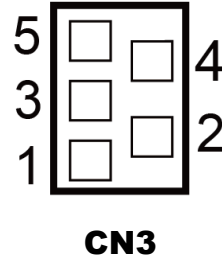

3.8.2 DVI Connector

Jumper Location: CN4

Description: DVI Connector

PIN	ASSIGNMENT	PIN	ASSIGNMENT
1	TMD_D2-	2	TMD_D2+
3	GND	4	NC
5	NC	6	DDC_CLK
7	DDC_DATA	8	VSYNC
9	TMDS_D1-	10	TMDS_D1+
11	GND	12	NC
13	NC	14	5V
15	GND	16	HPD
17	TMDS_0-	18	TMDS_D0+
19	GND	20	NC
21	NC	22	GND
23	TMDS_CLK+	24	TMDS_CLK-
C1	RED	C2	GREEN
C3	BLUE	C4	HSYNC
C5	GND	-	-

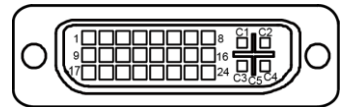

3.8.3 Panel B+ 3.3V / 5V / 12V Selection

Jumper Location: JP1

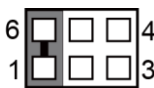
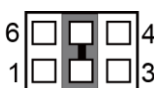
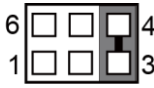

Description: Panel B+ 3.3V / 5V / 12V Selection

SELECTION	JUMPER SETTINGS	JUMPER ILLUSTRATION
3.3V	1-6	
5V	2-5	
12V	3-4	

3.8.4 PWM / Analog Selection

Jumper Location: JP2

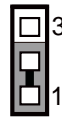
Description: PWM / Analog Selection

SELECTION	JUMPER SETTINGS	JUMPER ILLUSTRATION
PWM	1-2	 JP2
Analog	2-3	 JP2

3.8.5 LCD Panel for LVDS Connector

Jumper Location: J5

Description: LCD Panel for LVDS Connector

PIN	ASSIGNMENT	PIN	ASSIGNMENT
1	VDD	17	RXOIN3-
2	VDD	18	RXOIN3+
3	VDD	19	RXOINC-
4	VDD	20	RXOINC+
5	GND	21	RXOIN2-
6	GND	22	RXOIN2+
7	RXEIN3-	23	RXOIN1-
8	RXEIN3+	24	RXOIN1+
9	RXEINC-	25	RXOIN0
10	RXEINC+	26	RXOIN0+
11	RXEIN2-	27	NC
12	RXEIN2+	28	NC
13	RXEIN1-	29	NC
14	RXEIN1+	30	GND
15	RXEIN0	31	GND
16	RXEIN0+	32	GND

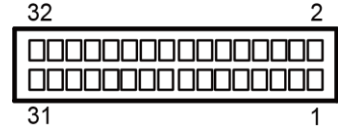

JP5

3.8.6 Key Pad Connector

Jumper Location: J6

Description: Key Pad Connector

PIN	ASSIGNMENT
1	SEL+(RIGHT)
2	SEL-(LEFT)
3	AUTO
4	MENU
5	POWER
6	LED-G
7	LED-R
8	GND
9	NC
10	NC

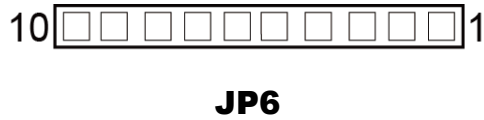

3.8.7 Inverter Connector

Jumper Location: J7

Description: Inverter Connector

PIN	ASSIGNMENT
1, 2	12V Input
4, 6	GND
3	Brightness control
5	ON/OFF Control
7, 8	5V Input / Output

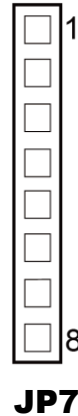

Note: Pins 1~5 are used for standard 12V input and stand alone Inverter.
Pins 6~8 are used for power supply with 5V input .

3.8.8 UART Connector

Jumper Location: J9

Description: UART Connector

PIN	ASSIGNMENT
1	V5B
2	Key2
3	Tx
4	Rx
5	GND



JP9

3.8.9 IR Connector

Jumper Location: J11

Description: IR Connector

PIN	ASSIGNMENT
1	V5A
2	IR
3	GND



JP11

3.8.10 Ext. Amp. Connector

Jumper Location: J12

Description: Ext. Amp. Connector

PIN	ASSIGNMENT
1	L_10W
2	R_10W
3	Mute_AMP
4	STB_AMP
5	GND

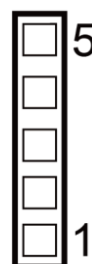

JP12

4 Software Utilities

This chapter provides the detailed information that guides users to install driver utilities for the system. The following topics are included:

- Installing Intel® Chipset Software Installation Utility
- Installing Intel® Trusted Execution Engine Installation Utility
- Installing USB 3.0 eXtensible Host Controller Utility
- Installing Graphics Driver Utility
- Installing LAN Driver Utility
- Installing Sound Driver Utility

4.1 Introduction

Enclosed with the KS-1330 Series package is our driver utilities contained in a DVD-ROM disk. Refer to the following table for driver locations:

Filename (Assume that DVD-ROM drive is D :)	Purpose	DOS	Win7 (32/64 bit)
D:\Driver\Flash BIOS	For Aptio(EFI) BIOS update utility	✓	X
D:\Driver\Platform\Main Chip	Intel(R) Chipset Device Software Installation Utility	X	✓
D:\Driver\Platform\Graphics	Intel Atom E3827 For VGA Driver installation	X	✓
D:\Driver\Platform\TXE	For Intel Trusted Execution Engine Interface	X	✓
D:\Driver\Platform\LAN Chip	Intel I210IT & I210AT For LAN Driver installation	X	✓
D:\Driver\Platform\Sound Codec	Realtek ALC888 For Sound driver installation	X	✓
D:\Driver\Platform\USB3	Intel(R) USB 3.0 eXtensible Host Controller	X	✓
D:\Driver\Platform\KMDF For Win7	Windows 7 update KMDF	X	✓

Filename (Assume that DVD-ROM drive is D :)	Purpose	DOS	Win10 (32/64 bit)
D:\Driver\Flash BIOS	For Aptio(EFI) BIOS update utility	✓	X
D:\Driver\Platform\Main Chip	Intel(R) Chipset Device Software Installation Utility	X	✓
D:\Driver\Platform\Graphics	Intel Atom E3827 For VGA Driver installation	X	✓
D:\Driver\Platform\TXE	For Intel Trusted Execution Engine Interface	X	✓
D:\Driver\Platform\LAN Chip	Intel I210IT & I210AT For LAN Driver installation	X	✓
D:\Driver\Platform\Sound Codec	Realtek ALC888 For Sound driver installation	X	✓

X : Not support

✓ : Support

Note: Install the driver utilities immediately after the OS installation is completed.

For more details on the installation procedure, refer to the README.txt file.

4.2 Installing Intel® Chipset Software Installation Utility

4.2.1 Introduction

The Intel® Chipset Software Installation Utility installs the Windows *.INF files to the target system. These files outline to the operating system how to configure the Intel chipset components in order to ensure that the following functions work properly:

- Core PCI and ISAPNP Services
- PCIe Support
- SATA Storage Support
- USB Support
- Identification of Intel® Chipset Components in the Device Manager

4.2.2 Intel® Chipset Software Installation Utility

The utility pack is to be installed only for Windows® 7/10 series, and it should be installed immediately after the OS installation is finished. Please follow the steps below:

- 1** Connect the USB DVD-ROM device to KS-1330 and insert the driver disk.
- 2** Enter the **Main Chip** folder where the Chipset driver is located.
- 3** Select Windows 7 (32/64-bit) / Windows 10 (64-bit) for your OS platform.
- 4** Click the chipset driver installation file for driver installation.
- 5** Follow the on-screen instructions to install the driver.
- 6** Once the installation is completed, shut down the system and restart KS-1330 for the changes to take effects.

4.3 Intel® Trusted Execution Engine Installation Utility

For Windows 7 only. Pre-install Microsoft's Kernel-Mode Driver Framework (KMDF) version 1.11 before you install the Intel® Trusted Execution Engine Installation Utility (TXE) in order to avoid errors in Device Manager.

Installation Instructions for Kernel-Mode Driver Framework (KMDF)

To install the Kernel-Mode Driver Framework (KMDF), follow the steps below:

- 1 Insert the driver disk into a DVD-ROM device.
- 2 (For Windows 7 only) Enter the **KMDF** folder where the installation driver file is located.
- 3 (For Windows 7 only) Click the **Setup kmdf-1.11.exe** file for driver installation.

Installation Instructions for Intel® Trusted Execution Engine Installation Utility

- 1 Connect the USB DVD-ROM device to KS-1330 and insert the driver disk.
- 2 Enter the **TXE** folder where the driver is located.
- 3 Select Windows 7 (32/64-bit) for your OS platform.
- 4 Click **SetupTXE.exe** file for TXE driver installation.
- 5 Follow the on-screen instructions to complete the installation.
- 6 Once the installation is completed, shut down the system and restart KS-1330 for the changes to take effect.

4.4 Intel® USB 3.0 eXtensible Host Controller Utility

Intel® USB 3.0 eXtensible Host Controller Driver supports the following Intel® Chipsets/Processors:

- Intel® 8 Series/C220 series Chipset Family
- Intel® 4th Generation Core™ Processors
- Intel® C610 series Chipset Family
- Intel® 9 Series Chipset Family
- Intel® Pentium® Processor or Intel® Celeron® Processor N- & J-Series
- Intel® 5th generation Intel® Core™ Processors
- Intel® Core™ M Processor
- Intel® 6th generation Intel® Core™ processors
- Intel® 100 Series Chipset Family

To install the utility, follow the steps below:

- 1** Insert the driver disk into a DVD-ROM device.
- 2** Under Windows system, go to the directory where the driver is located.
- 3** Run the application with administrative privileges.

4.5 Installing Graphics Driver Utility

To install the Graphics driver utility, follow the steps below:

- 1** Connect the USB DVD-ROM device to KS-1330 and insert the driver disk.
- 2** Enter the **Graphic** folder where the driver is located.
- 3** Select Windows 7 (32/64-bit) / Windows 10 (64-bit) for your OS platform.
- 4** Click the graphics driver installation file for driver installation.
- 5** Follow the on-screen instructions to complete the installation.
- 6** Once the installation is completed, shut down the system and restart KS-1330 for the changes to take effect.

4.6 Installing LAN Driver Utility

Enhanced with LAN function, KS-1330 supports various network adapters. To install the LAN Driver, follow the steps below:

- 1** Connect the USB DVD-ROM device to KS-1330 and insert the driver disk.
- 2** Enter the **LAN Chip** folder where the driver is located.
- 3** Select Windows 7 (32/64-bit) / Windows 10 (64-bit) for your OS platform.
- 4** Click the LAN driver installation file for driver installation.
- 5** Follow the on-screen instructions to complete the installation.
- 6** Once the installation is completed, shut down the system and restart KS-1330 for the changes to take effects.

4.7 Installing Sound Driver Utility

The sound function enhanced in this system is fully compatible with Windows® 7 / 10 series.

To install the Sound Driver, follow the steps below:

- 1** Connect the USB DVD-ROM device to KS-1330 and insert the driver disk.
- 2** Open the **Sound Codec** folder where the driver is located.
- 3** Select Windows 7 (32/64-bit) / Windows 10 (64-bit) for your OS platform.
- 4** Click the **Sound driver installation** file for driver installation.
- 5** Follow the on-screen instructions to complete the installation.
- 6** Once the installation is completed, shut down the system and restart KS-1330 for the changes to take effect.

5

BIOS SETUP

This chapter guides users how to configure the basic system configurations via the BIOS (Basic Input / Output System) Setup Utilities. The information of the system configuration is saved in battery-backed CMOS RAM and BIOS NVRAM so that the Setup information is retained when the system is powered off. The BIOS Setup Utilities consist of the following menu items:

- Accessing Setup Utilities
- Main Menu
- Advanced Menu
- Chipset Menu
- Security Menu
- Boot Menu
- Save & Exit Menu

5.1 Introduction

The KS-1330 System uses an AMI (American Megatrends Incorporated) Aptio BIOS that is stored in the Serial Peripheral Interface Flash Memory (SPI Flash) and can be updated. The SPI Flash contains the built-in BIOS setup program, Power-On Self-Test (POST), PCI auto-configuration utility, LAN EEPROM information, and Plug and Play support.

Aptio is AMI's BIOS firmware based on the UEFI (Unified Extensible Firmware Interface) specifications and the Intel Platform Innovation Framework for EFI. The UEFI specification defines an interface between the operating system and platform firmware. The interface consists of data tables that contain platform-related information, boot service calls, and runtime service calls that are available to the operating system and its loader. These elements have combined to provide a standard environment for booting the operating system and running pre-boot applications.

The diagram below shows the Extensible Firmware Interface's location in the software stack.

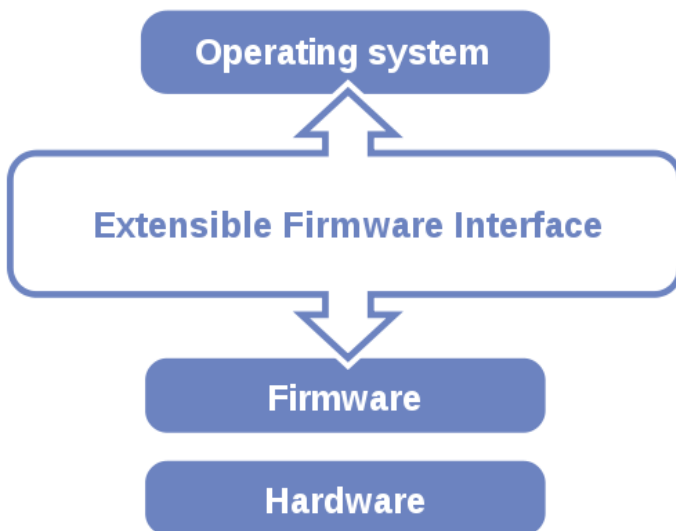

Figure 5-1. Extensible Firmware Interface Diagram

EFI BIOS provides an user interface that allows you to modify hardware configuration, e.g. change the system date and time, enable/disable a system component, determine bootable device priority, set up personal password, etc., which is convenient for engineers to perform modifications and customize the computer system and allows technicians to troubleshoot the occurred errors when the hardware is faulty.

The BIOS setup menu allows users to view and modify the BIOS settings for the computer. After the system is powered on, users can access the BIOS setup menu by pressing or <Esc> immediately while the POST message is running before the operating system is loading.

All the menu settings are described in details in this chapter.

5.2 Accessing Setup Utility

After the system is powered on, BIOS will enter the Power-On Self-Test (POST) routines and the POST message will be displayed:



Figure 5-2. POST Screen with AMI Logo

Press or <Esc> to access the Setup Utility program and the **Main** menu of the Aptio Setup Utility will appear on the screen as below:

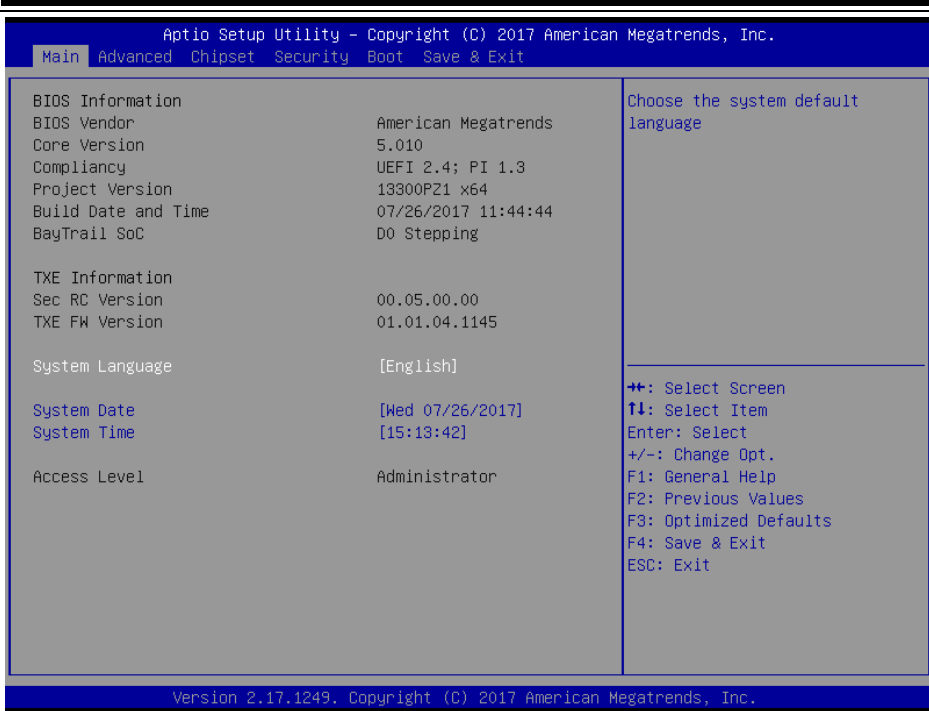

BIOS Setup Menu Initialization Screen

You may move the cursor by <↑> and <↓> keys to highlight the individual menu items. As you highlight each item, a brief description of the highlighted selection will appear on the right side of the screen.

The language of the BIOS setup menu interface and help messages are shown in US English. You may use <↑> or <↓> key to select among the items and press <Enter> to confirm and enter the sub-menu. The following table provides the list of the navigation keys that you can use while operating the BIOS setup menu.

BIOS Setup Navigation Key	Description
<←> and <→>	Select a different menu screen (move the cursor from the selected menu to the left or right).
<↑> and <↓>	Select a different item (move the cursor from the selected item upwards or downwards)
<Enter>	Execute the command or select the sub-menu.
<F2>	Load the previous configuration values.
<F3>	Load the default configuration values.
<F4>	Save the current values and exit the BIOS setup menu.
<Esc>	Close the sub-menu. Trigger the confirmation to exit BIOS setup menu.

5.3 Main

Menu Path *Main*

The **Main** menu allows you to view the BIOS Information, change the system date and time, and view the user access privilege level. Use tab to switch between date elements. Use <↑> or <↓> arrow keys to highlight the item and enter the value you want in each item. This screen also displays the BIOS version (project) and BIOS Build Date and Time.

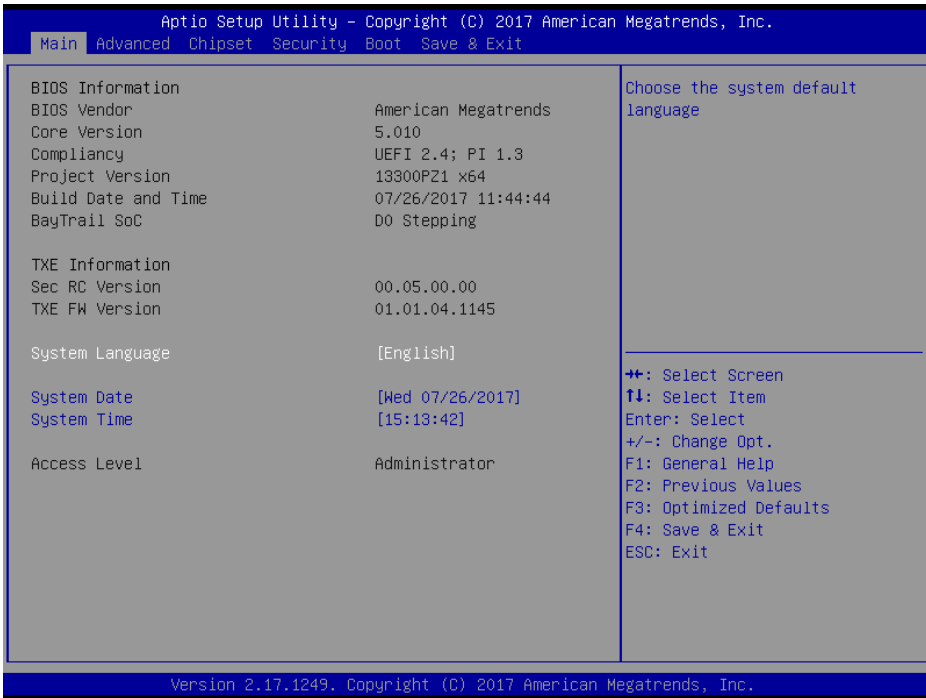

Main Screen

BIOS Setting	Options	Description/Purpose
BIOS Vendor	No changeable options	Displays the BIOS vendor.
Core Version	No changeable options	Displays the current BIOS core version.
Compliance	No changeable options	Displays the current UEFI version.
Project Version	No changeable options	Displays the version of the BIOS currently installed on the platform.
Build Date and Time	No changeable options	Displays the date of current BIOS version.
BayTrail SoC	No changeable options	SoC stepping

BIOS Setting	Options	Description/Purpose
Sec RC Version	No changeable options	Displays the current Sec RC version.
TXE FW Version	No changeable options	Displays the current TXE Version
System Language	English	BIOS Setup language.
System Date	Month, day, year	Sets the system date. The format is [Day Month/ Date/ Year]. Users can directly enter values or use <+> or <-> arrow keys to increase/decrease it. The “Day” is automatically changed.
System Time	Hour, minute, second	Sets the system time. The format is [Hour: Minute: Second]. Users can directly enter values or use <+> or <-> arrow keys to increase/decrease it.
Access Level	No changeable options	Displays the access level as “Administrator”.

5.4 Advanced

Menu Path *Advanced*

This menu provides advanced configurations such as sub-menus of ACPI Settings, F81866 Super IO Configuration, Hardware Monitor, F81866 Watchdog, CPU Configuration, IDE Configuration, CSM Configuration and USB Configuration.

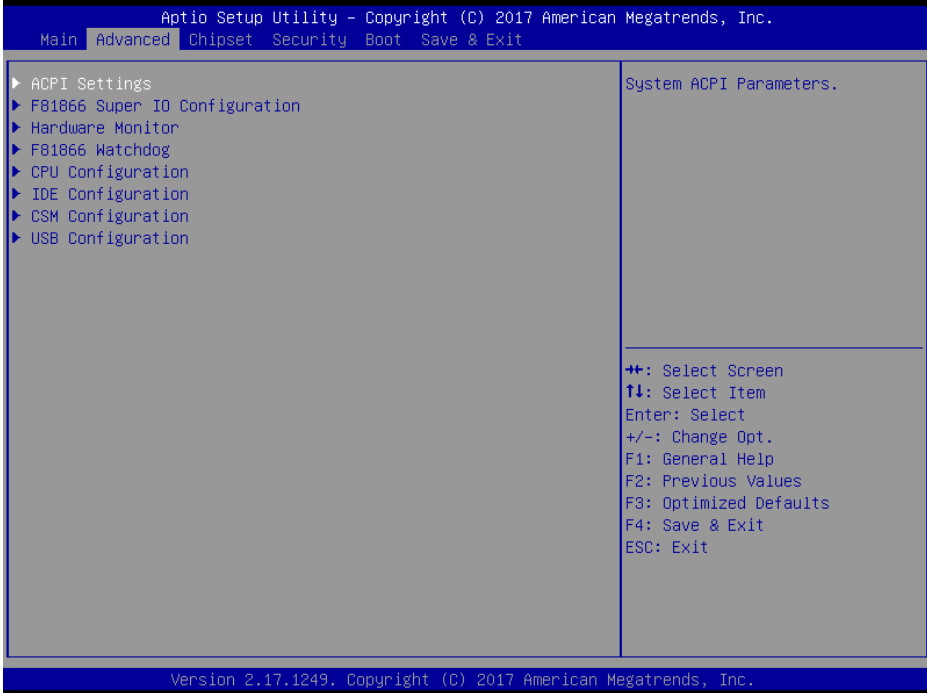

Advanced Menu Screen

BIOS Setting	Options	Description/Purpose
ACPI Settings	Sub-Menu	System ACPI Parameters.
F81866 Super IO Configuration	Sub-Menu	Super I/O Chip Configuration.
Hardware Monitor	Sub-Menu	Monitor hardware status
F81866 Watchdog	Sub-Menu	F81866 Watchdog Parameters.
CPU Configuration	Sub-Menu	CPU Configuration Parameters.
IDE Configuration	Sub-Menu	SATA Configuration Parameters.
CSM Configuration	Sub-Menu	Configures Option ROM execution, boot options filters, etc.
USB Configuration	Sub-Menu	USB Configuration Parameters.

5.4.1 Advanced – ACPI Settings

Menu Path *Advanced > ACPI Settings*

The **ACPI Settings** allows users to configure relevant ACPI (Advanced Configuration and Power Management Interface) settings, such as Enable/Disable ACPI Auto Configuration, Enable/Disable Hibernation, ACPI Sleep State and lock legacy resources.

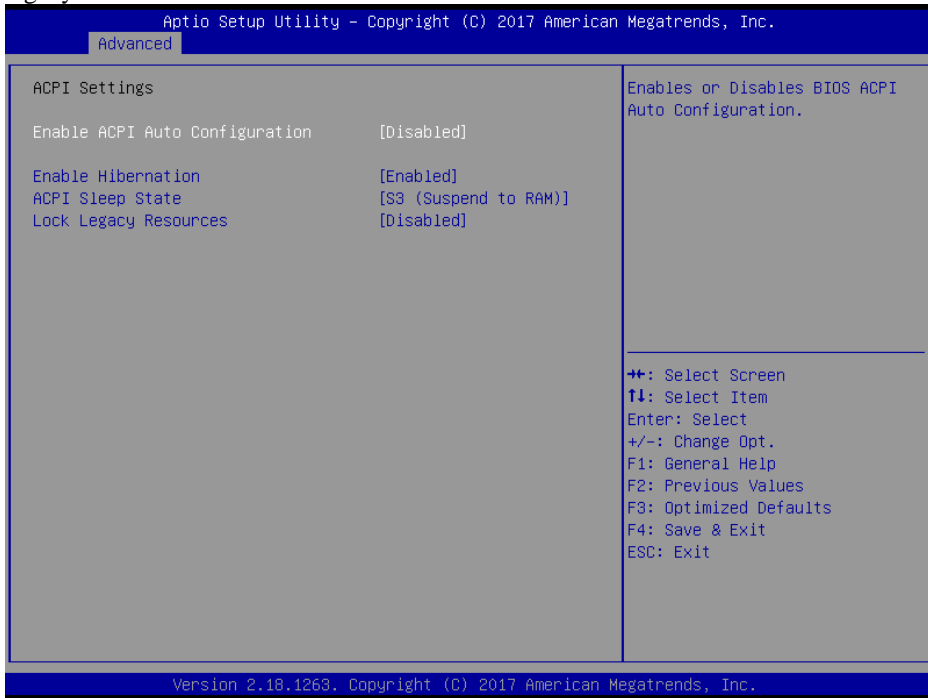

ACPI Settings Screen

BIOS Setting	Options	Description/Purpose
Enable ACPI Auto Configuration	- Disabled - Enabled	Enables or Disables ACPI feature.
Enable Hibernation	- Disabled - Enabled	Enables or Disables System ability to Hibernate (OS/S4 Sleep State). This option may be not effective with some OS.
ACPI Sleep State	- Suspend Disabled - S3 Only (Suspend to RAM)	Specifies the ACPI sleep state. <ul style="list-style-type: none"> • Suspend Disabled disables ACPI sleep feature. • S3 allows the platform to enter

BIOS Setting	Options	Description/Purpose
		Suspend to RAM mode.
Lock Legacy Resources	- Disabled - Enabled	Enables or Disables Lock of Legacy Resources.

5.4.2 Advanced – F81866 Super IO Configuration

Menu Path *Advanced > F81866 Super IO Configuration*

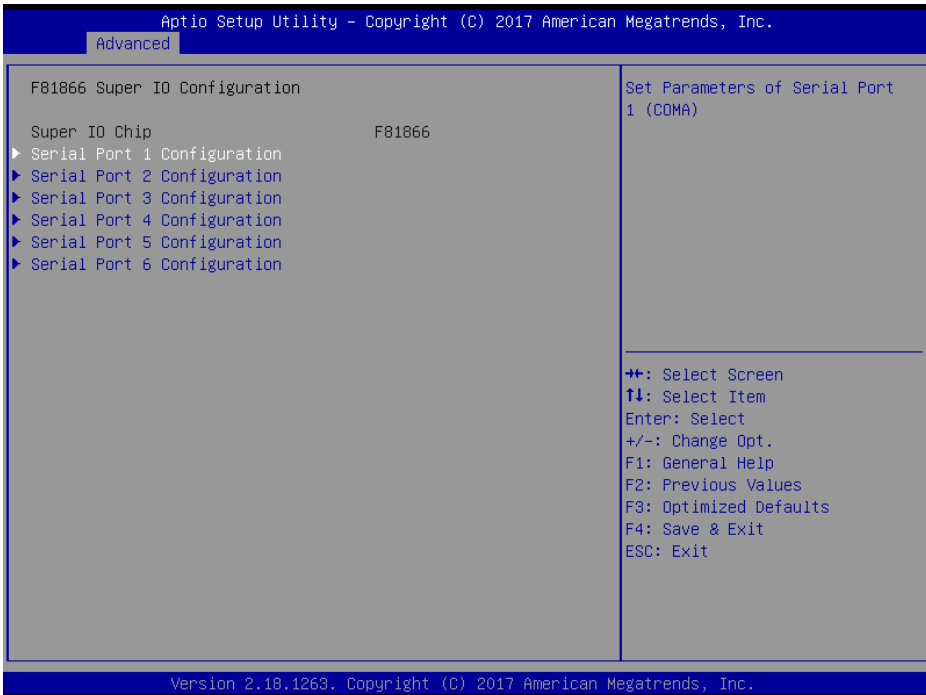

F81866 Super IO Configuration Screen

BIOS Setting	Options	Description/Purpose
Super IO Chip	No changeable options	Displays the super I/ O chip model and its manufacturer.
Serial Port 1 Configuration	Sub-menu	Sets the parameters of Serial Port 1 (COMA).
Serial Port 2 Configuration	Sub-menu	Sets the parameters of Serial Port 2 (COMB).
Serial Port 3 Configuration	Sub-menu	Sets the parameters of Serial Port 3 (COMC).
Serial Port 4 Configuration	Sub-menu	Sets the parameters of Serial Port 4 (COMD).

BIOS Setting	Options	Description/Purpose
Serial Port 5 Configuration	Sub-menu	Sets the parameters of Serial Port 5 (COME).
Serial Port 6 Configuration	Sub-menu	Sets the parameters of Serial Port 6 (COMF).

Menu Path *Advanced > F81866 Super IO Configuration > Serial Port 1 Configuration*

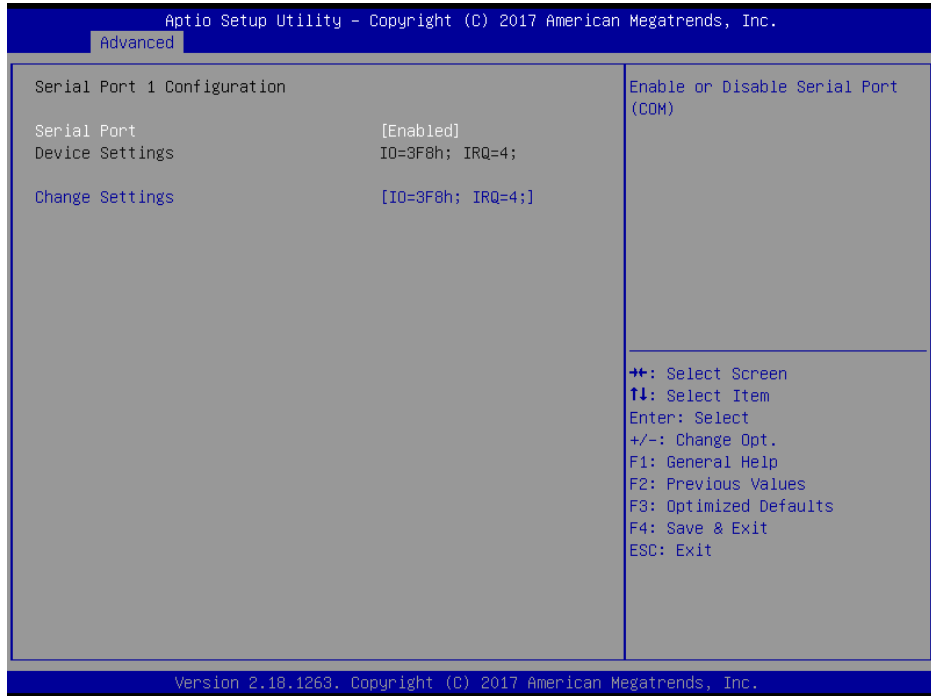

Serial Port 1 Configuration Screen

BIOS Setting	Options	Description/Purpose
Serial Port	- Disabled - Enabled	Enables or Disables Serial Port 1.
Device Settings	No changeable options	Displays the current settings of Serial Port 1.
Change Settings	- IO=3F8h; IRQ=4 - IO=3F8h; IRQ=3,4,5,6,7,9,10,11,12 - IO=2F8h; IRQ=3,4,5,6,7,9,10,11,12 - IO=3E8h; IRQ=3,4,5,6,7,9,10,11,12 - IO=2E8h; IRQ=3,4,5,6,7,9,10,11,12	Allows you to select specific IO address and IRQ for Serial Port 1.

Menu Path *Advanced > F81866 Super IO Configuration >
Serial Port 2 Configuration*

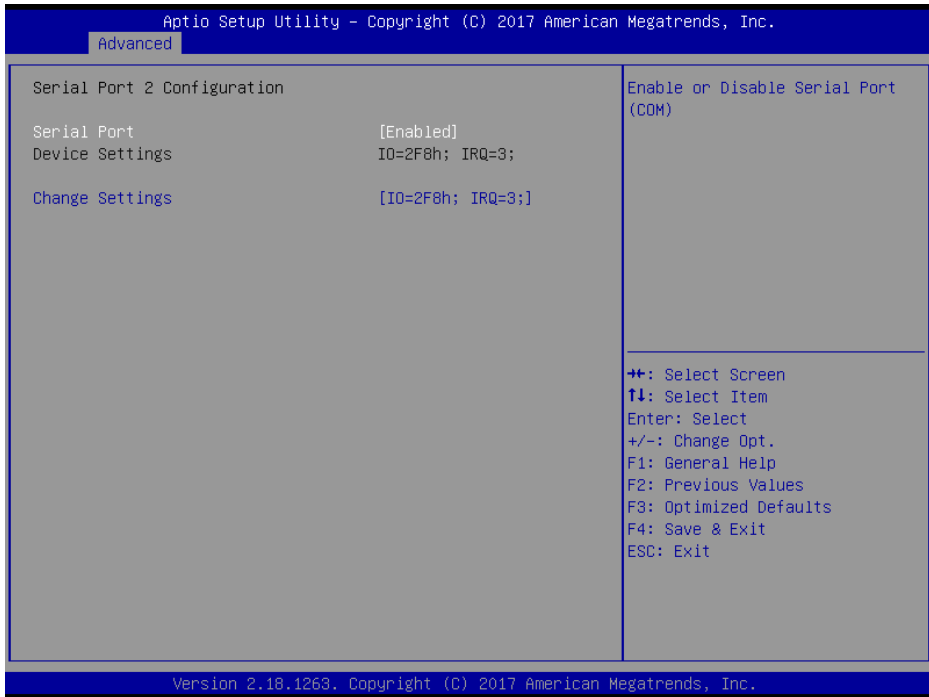

Serial Port 2 Configuration Screen

BIOS Setting	Options	Description/Purpose
Serial Port	- Disabled - Enabled	Enables or Disables Serial Port 2.
Device Settings	No changeable options	Displays the current settings of Serial Port 2.
Change Settings	- IO=2F8h; IRQ=3 - IO=3F8h; IRQ=3,4,5,6,7,9,10,11,12 - IO=2F8h; IRQ=3,4,5,6,7,9,10,11,12 - IO=3E8h;IRQ=3,4,5,6,7,9,10,11,12 - IO=2E8h;IRQ=3,4,5,6,7,9,10,11,12	Allows you to select specific IO address and IRQ for Serial Port 2.

Menu Path *Advanced > F81866 Super IO Configuration >
Serial Port 3 Configuration*

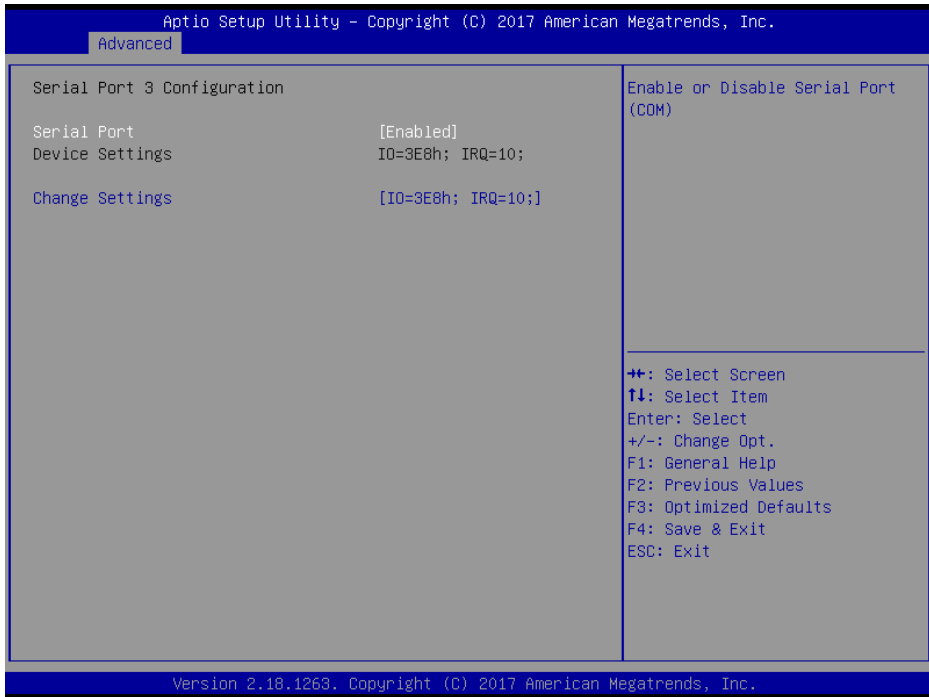

Serial Port 3 Configuration Screen

BIOS Setting	Options	Description/Purpose
Serial Port	- Disabled - Enabled	Enables or Disables Serial Port 3.
Device Settings	No changeable options	Displays the current settings of Serial Port 3.
Change Settings	- IO=3E8h; IRQ=10 - IO=3F8h; IRQ=3,4,5,6,7,9,10,11,12 - IO=2F8h; IRQ=3,4,5,6,7,9,10,11,12 - IO=2F0h; IRQ=3,4,5,6,7,9,10,11,12 - IO=2E0h; IRQ=3,4,5,6,7,9,10,11,12	Allows you to select specific IO address and IRQ for Serial Port 3.

Menu Path *Advanced > F81866 Super IO Configuration > Serial Port 4 Configuration*

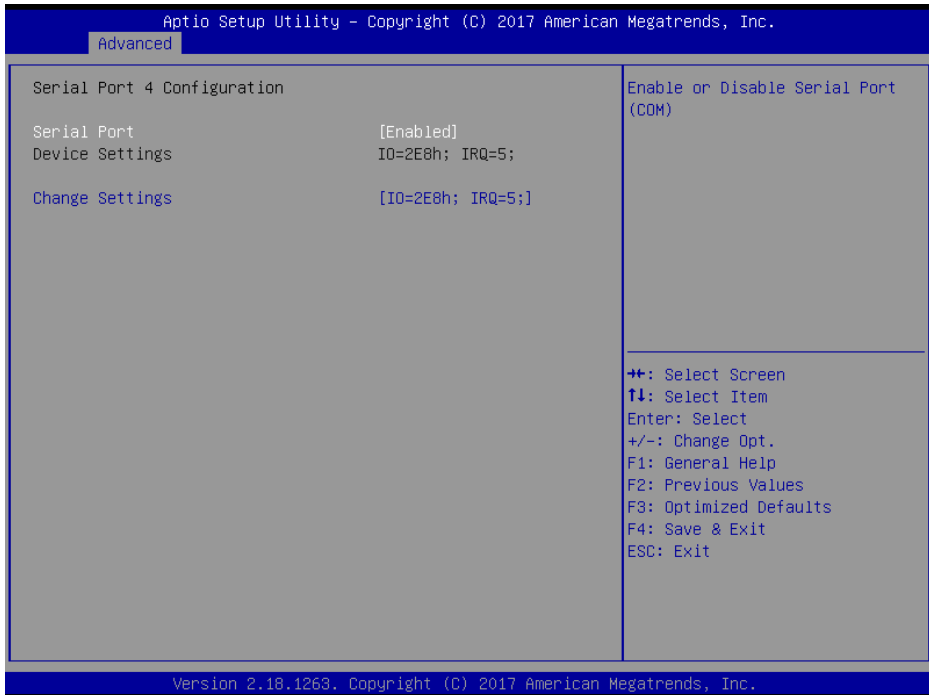

Serial Port 4 Configuration Screen

BIOS Setting	Options	Description/Purpose
Serial Port	- Disabled - Enabled	Enables or Disables Serial Port 4.
Device Settings	No changeable options	Displays the current settings of Serial Port 4.
Change Settings	- IO=2E8h; IRQ=5 - IO=3E8h;IRQ=3,4,5,6,7,9,10,11,12 - IO=2E8h;IRQ=3,4,5,6,7,9,10,11,12 - IO=2F0h;IRQ=3,4,5,6,7,9,10,11,12 - IO=2E0h;IRQ=3,4,5,6,7,9,10,11,12	Allows you to select specific IO address and IRQ for Serial Port 4.

Menu Path *Advanced > F81866 Super IO Configuration >
Serial Port 6 Configuration*

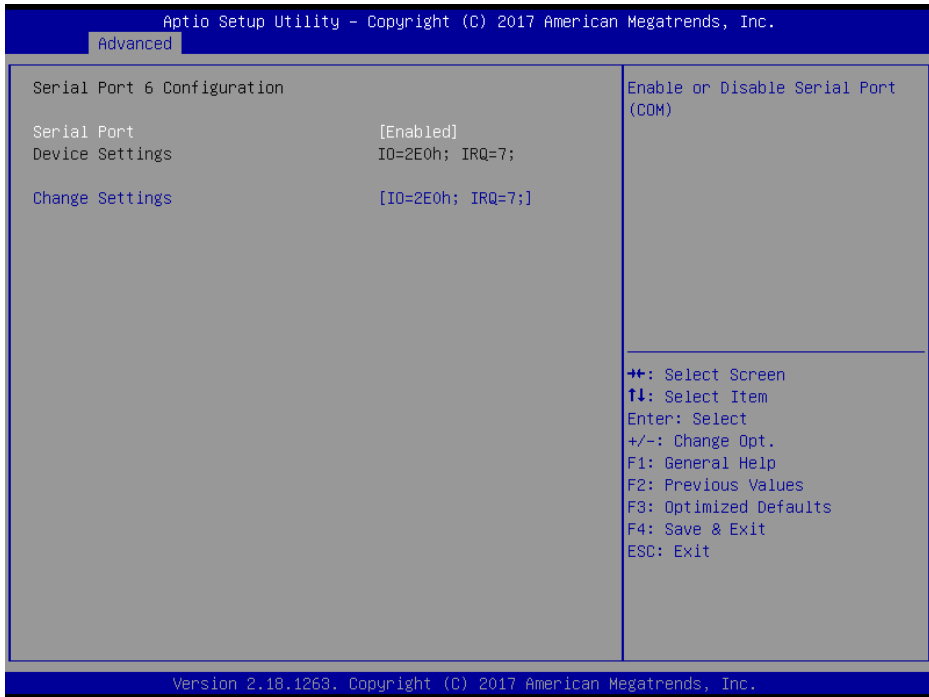

Serial Port 6 Configuration Screen

BIOS Setting	Options	Description/Purpose
Use This Device	- Disabled - Enabled	Enables or Disables Serial Port 6.
Device Settings	No changeable options	Displays the current settings of Serial Port 6.
Change Settings	- IO=2E0h; IRQ=7 - IO=3E8h;IRQ=3,4,5,6,7,9,10,11,12 - IO=2E8h;IRQ=3,4,5,6,7,9,10,11,12 - IO=2F0h;IRQ=3,4,5,6,7,9,10,11,12 - IO=2E0h;IRQ=3,4,5,6,7,9,10,11,12	Allows you to select specific IO address and IRQ for Serial Port 6.

5.4.3 Advanced – Hardware Monitor

Menu Path *Advanced > Hardware Monitor*

The **Hardware Monitor** allows users to monitor the health and status of the system such as CPU temperature, system temperature, CPU/System Fan speed and voltage levels in supply.

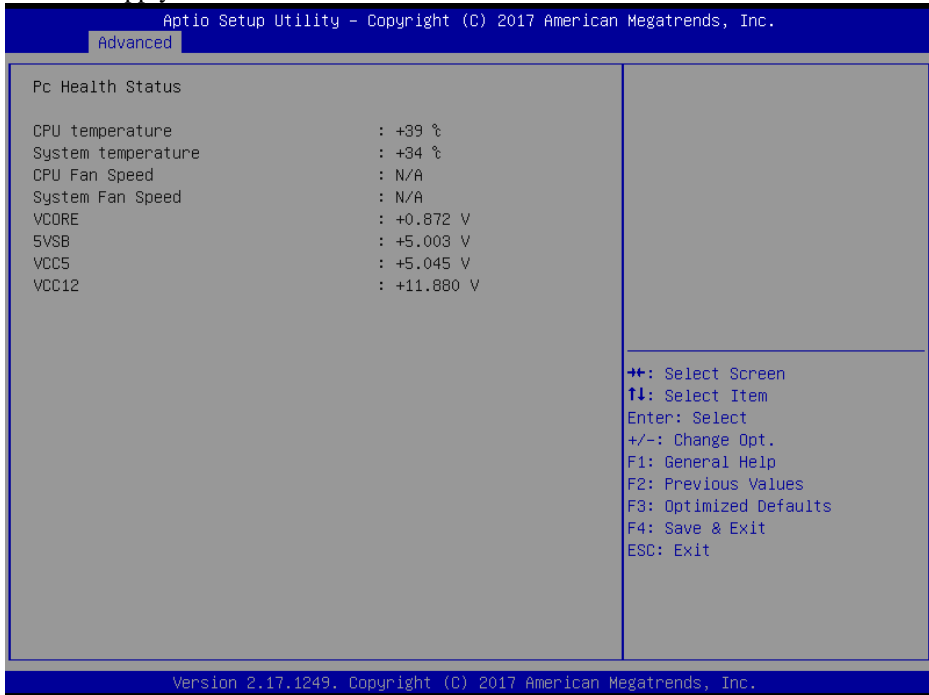

Hardware Monitor Screen

BIOS Setting	Options	Description/Purpose
CPU Temperature	No changeable options	Displays the processor's temperature.
System Temperature	No changeable options	Displays system's temperature.
CPU Fan Speed	No changeable options	Displays CPU fan's speed.
System Fan Speed	No changeable options	Displays system fan's speed
VCORE	No changeable options	Detects and displays the VCORE CPU voltage.
5VSB	No changeable options	Detects and displays voltage level of the VSB5V in supply.
VCC5	No changeable options	Detects and displays voltage level of the VCC5V in supply.
VCC12	No changeable options	Detects and displays voltage level of the VCC12 in supply.

5.4.4 Advanced – F81866 Watchdog Configuration

Menu Path *Advanced > F81866 Watchdog*

If the system hangs or fails to respond, enable the F81866 Watchdog function to trigger a system reset via the 255-level watchdog timer.



F81866 Watchdog Configuration Screen

BIOS Setting	Options	Description/Purpose
Enable Watchdog	- Enabled - Disabled	Enables/Disables F81866 Watchdog timer settings.
Watchdog timer unit	- 1s - 60s	Selects 1s (second) or 60s (minute) as the time unit of Watchdog timer.
Count for Timer (Seconds)	Numeric (from 1 to 255)	Sets the timeout for Watchdog timer. (Max. value: 255 seconds or minutes)

5.4.5 Advanced – CPU Configuration

Menu Path *Advanced > CPU Configuration*

The **CPU Configuration** provides advanced CPU settings and some information about CPU.

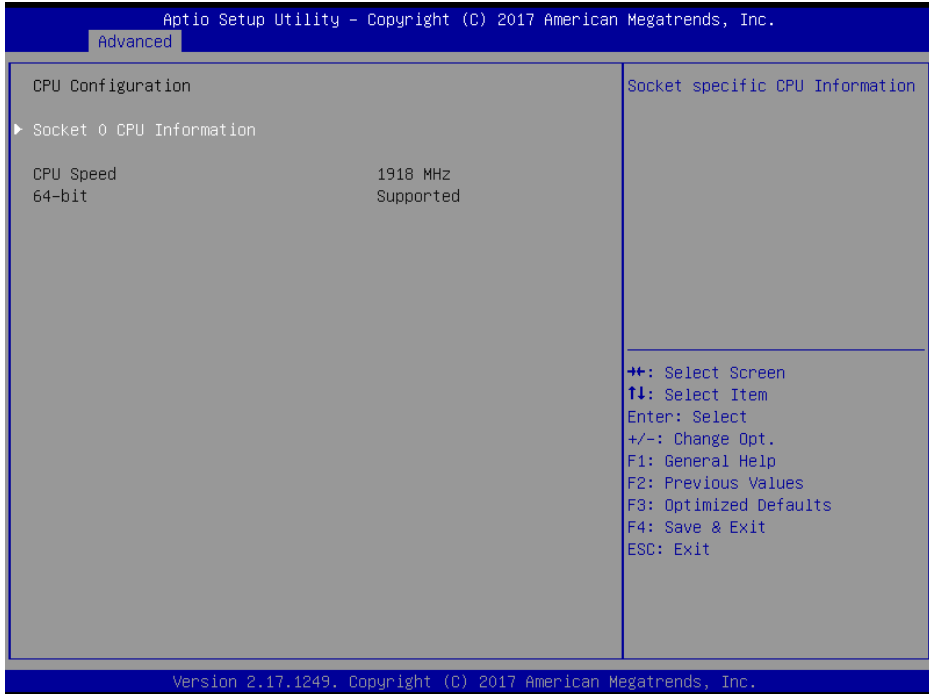

CPU Configuration Screen

BIOS Setting	Options	Description/Purpose
Socket 0 CPU Information	Sub-Menu	Reports CPU Information
CPU Speed	No changeable options	Reports the current CPU Speed.
64-bit	No changeable options	Reports if the processor supports Intel x86-64 (amd64) implementation.

Menu Path *Advanced > CPU Configuration > Socket 0 CPU Information*

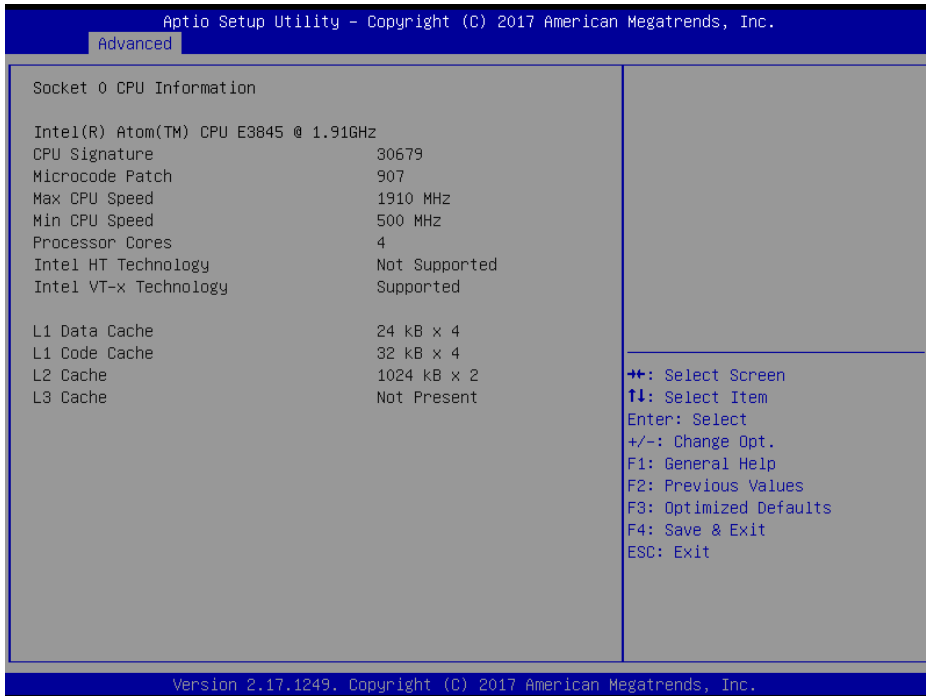

BIOS Setting	Options	Description/Purpose
CPU Signature	No changeable options	Reports the CPU Signature
Microcode Patch	No changeable options	Reports the CPU Microcode Patch Version.
Max CPU Speed	No changeable options	Reports the maximum CPU speed.
Min CPU Speed	No changeable options	Reports the minimum CPU speed
Processor Cores	No changeable options	Displays the number of physical cores in the processor.
Intel HT Technology	No changeable options	Reports if Intel Hyper-Threading Technology is supported by the processor
Intel VT-x Technology	No changeable options	Reports if Intel VT-x Technology is supported by the processor.
L1 Data Cache	No changeable options	Displays L1 Data Cache size.
L1 Code Cache	No changeable options	Displays L1 Code Cache size.
L2 Cache	No changeable options	Displays L2 Cache size.
L3 Cache	No changeable options	Displays L3 Cache size.

5.4.6 Advanced – IDE Configuration

Menu Path *Advanced > IDE Configuration*

The **IDE Configuration** allows users to enable / disable the SATA controller as well as the operational mode after the SATA controller is enabled. The following screen indicates the functions available when the SATA controller is enabled and the AHCI mode is specified.

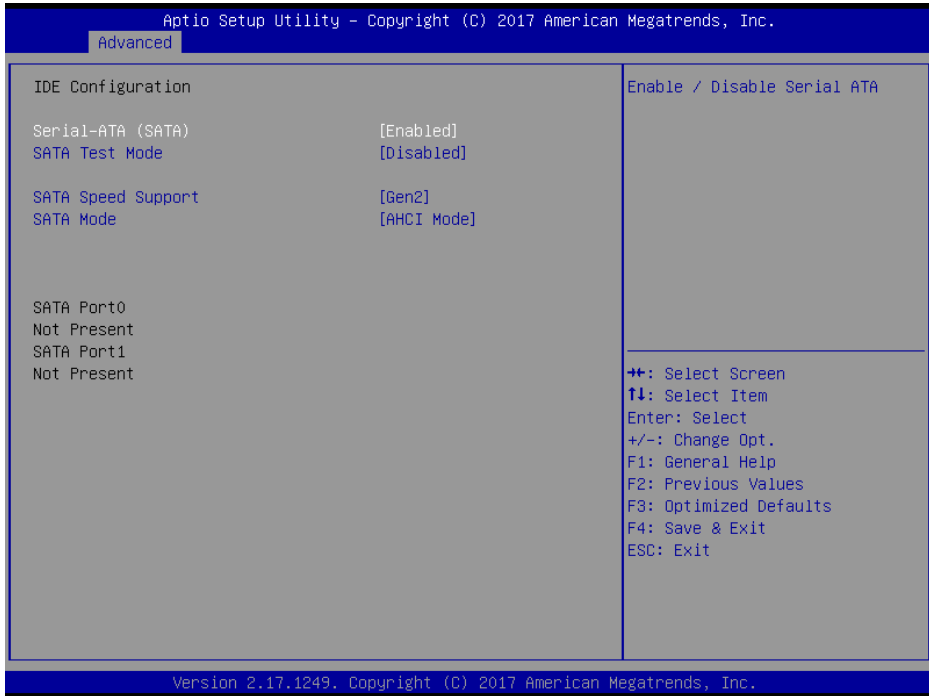

IDE Configuration Screen

BIOS Setting	Options	Description/Purpose
Serial-ATA (SATA)	- Disabled - Enabled	Enables or disables SATA Device.
SATA Test Mode	- Disabled - Enabled	Enables or disables SATA Test Mode.
SATA Speed Support	- Gen 1 - Gen 2	<ul style="list-style-type: none"> • Gen1 mode sets the device to 1.5 Gbit/s speed. • Gen2 mode sets the device to 3 Gbit/s speed (in case it is compatible).

BIOS Setting	Options	Description/Purpose
SATA Mode	<ul style="list-style-type: none"> - IDE mode - AHCI mode 	Configures SATA as following: <ul style="list-style-type: none"> • IDE Mode: Set SATA IDE operation mode. • AHCI Mode: SATA works in the AHCI (Advanced Host Controller Interface) mode for achieving better performance.

5.4.7 Advanced – CSM Configuration

Menu Path *Advanced > CSM Configuration*

The **CSM Configuration** provides advanced CSM (Compatibility Support Module) configurations such as Enable/Disable CSM Support, configure Option ROM execution, boot option filter, etc.

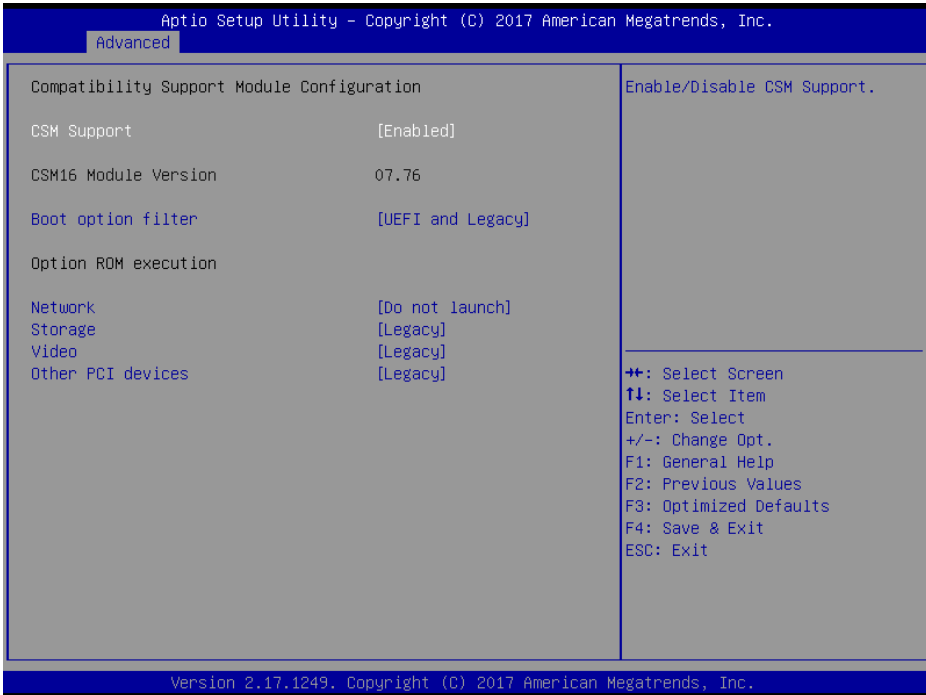

CSM Configuration Screen

BIOS Setting	Options	Description/Purpose
CSM Support	- Disabled - Enabled	Enables or Disables CSM Support.
CSM16 Module Version	No changeable options	Displays the CSM16 Module version.
Boot option filter	- UEFI and Legacy - Legacy only - UEFI only	This option controls the type of devices that the system can boot.
Network	- Do not launch - UEFI - Legacy	Controls the execution of UEFI or Legacy PXE.
Storage	- Do not launch - UEFI - Legacy	Controls the execution of UEFI or Legacy Storage.
Video	- Do not launch - UEFI - Legacy	Controls the execution of UEFI and Legacy Video.
Other PCI devices	- Do not launch - UEFI - Legacy	Select launch method for other PCI devices, such as NIC, mass storage or video card.

5.4.8 Advanced – USB Configuration

Menu Path *Advanced > USB Configuration*

The **USB Configuration** allows users to configure advanced USB settings such as Legacy USB support.

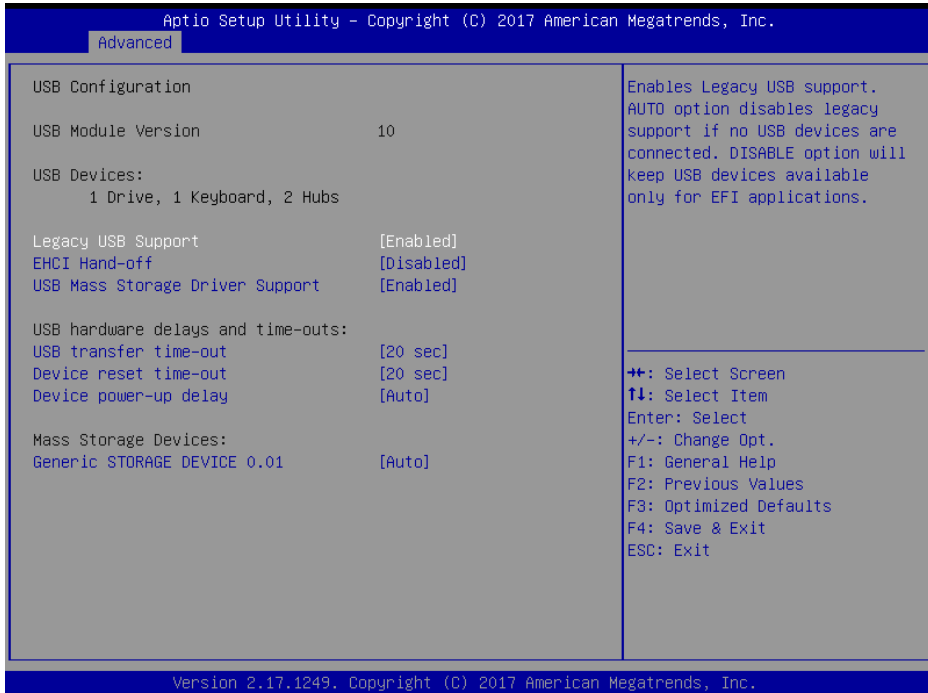

USB Configuration Screen

BIOS Setting	Options	Description/Purpose
USB Devices	No changeable options	Displays the number of available USB devices.
Legacy USB Support	- Disabled - Enabled - Auto	Enables support for legacy USB.
EHCI Hand-off	- Disabled - Enabled	This is a workaround for OSeS without EHCI hand-off support.
USB Mass Storage Driver Support.	- Disabled - Enabled	Enables/Disables USB mass storage driver support.
USB transfer time-out	1 / 5 / 10 / 20 sec	The time-out value for Control, Bulk, and Interrupt transfers.

BIOS Setting	Options	Description/Purpose
Device reset time-out	10 / 20 / 30 / 40 sec	USB mass storage device Start Unit command time-out.
Device power-up delay	- Auto - Manual	The maximum time the device will take before it properly reports itself to the Host Controller. 'Auto' uses default value: for a Root port it is 100 ms, for a Hub port the delay is taken from Hub descriptor.
Mass Storage Devices:	- Auto - Force FDD - Hard Disk - CD-ROM	Displays the device name and choose the device emulation type.

5.5 Chipset

Menu Path *Chipset*

This menu allows users to configure advanced Chipset settings such as North Bridge and South Bridge configuration parameters.

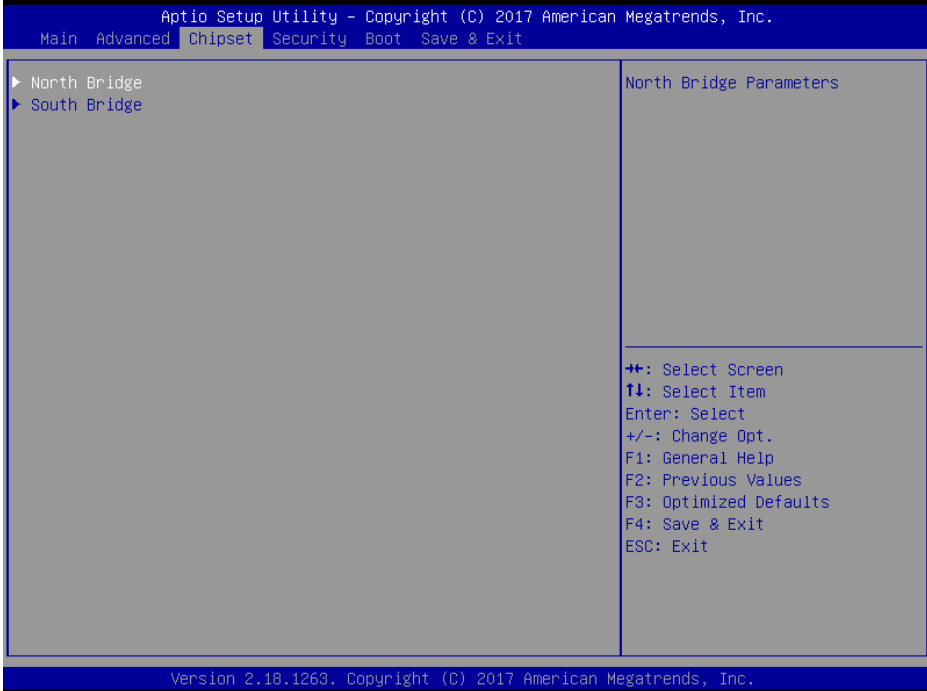

Chipset Screen

BIOS Setting	Options	Description/Purpose
North Bridge	Sub-menu	Sets Parameter for (North Bridge) configuration.
South Bridge	Sub-menu	Sets Parameter for (South Bridge) configuration.

5.5.1 Chipset – North Bridge

Menu Path *Chipset > North Bridge*

The **North Bridge** allows users to configure graphics settings and display the DRAM information on the platform.

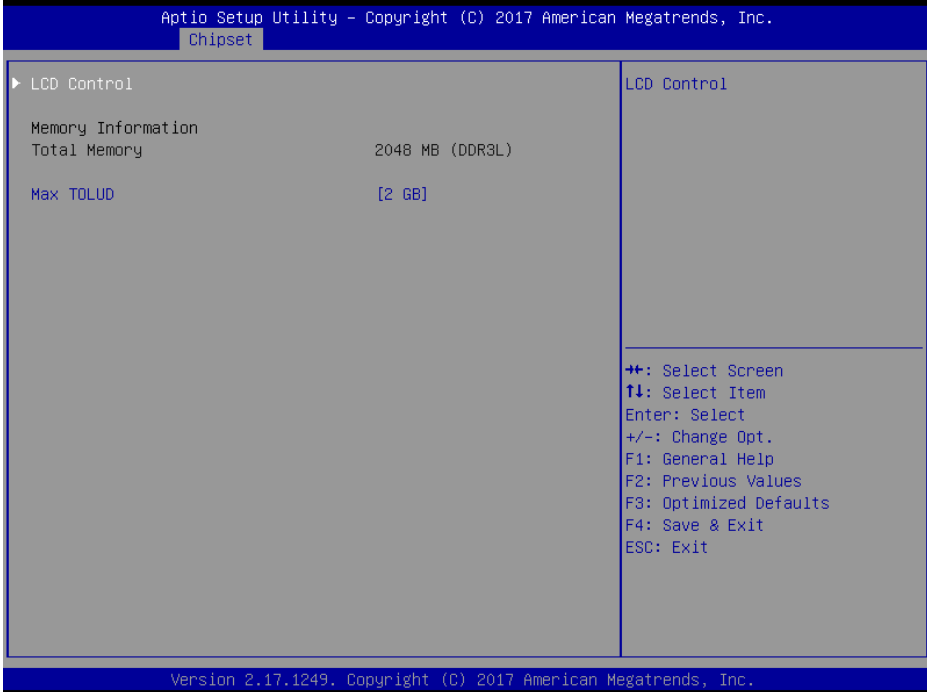

North Bridge Screen

BIOS Setting	Options	Description/Purpose
LCD Control	Sub-menu	LCD Control Settings.
Memory Information	No changeable options	Displays the DRAM information on the platform.
Total Memory	No changeable options	Displays the DRAM size
Max TOLUD	- 2 GB - 2.25 GB - 2.5 GB - 2.75 GB - 3 GB	Maximum Value of TOLUD (Top of Low Usable DRAM).

Menu Path *Chipset > North Bridge > LCD Control*

The **LCD Control** allows users to select the primary display device.

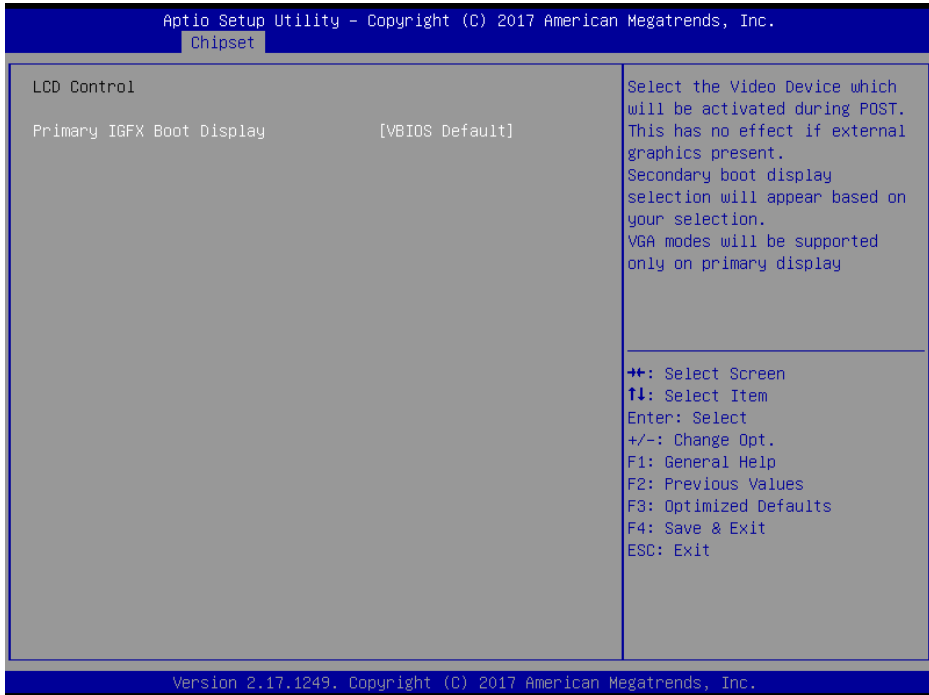

LCD Control Screen

BIOS Setting	Options	Description/Purpose
Primary IGFX Boot Display	<ul style="list-style-type: none"> - VBIOS Default - CRB - DVI - LVDS 	Select the video Device which will be activated during POST. This has no effect if an external graphics is present.

5.5.2 Chipset – South Bridge

Menu Path *Chipset > South Bridge*

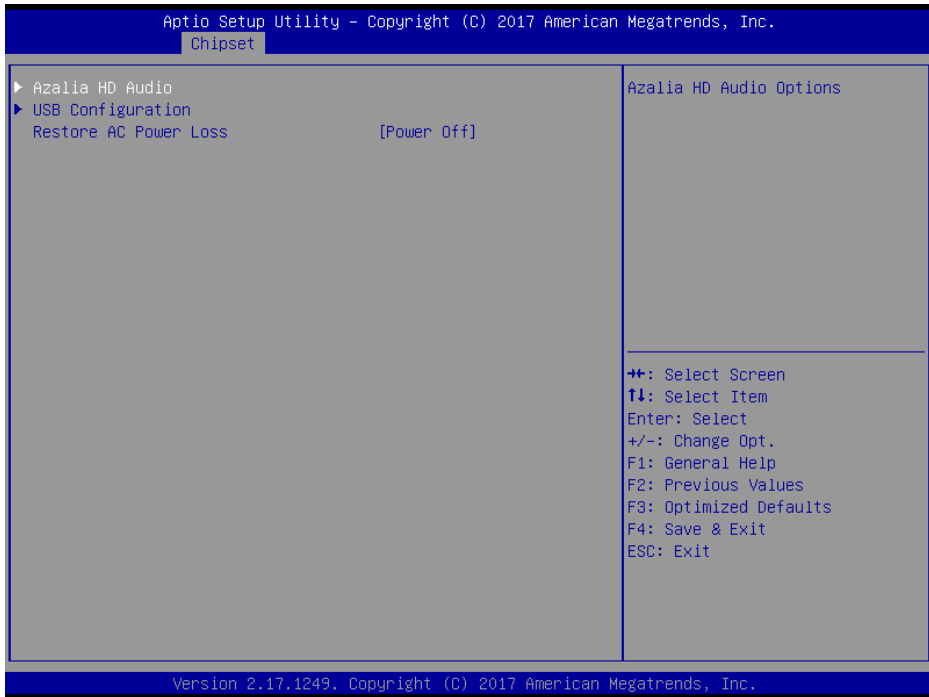

South Bridge Screen

BIOS Setting	Options	Description/Purpose
Azalia HD Audio	Sub-menu	Azalia HD Audio options.
USB Configuration	Sub-menu	Configure USB parameters.
Restore AC Power Loss	- Power Off - Power On - Last State	Select AC power state when power is re-applied after a power failure. <ul style="list-style-type: none"> • Power Off keeps the power off till the power button is pressed. • Power On makes the system power on after AC power is restored to the board. • Last State brings the system back to the last power state before AC power is removed.

Menu Path *Chipset > South Bridge > Azalia HD Audio*

The **Azalia HD Audio** allows users to control the detection of the Azalia device.

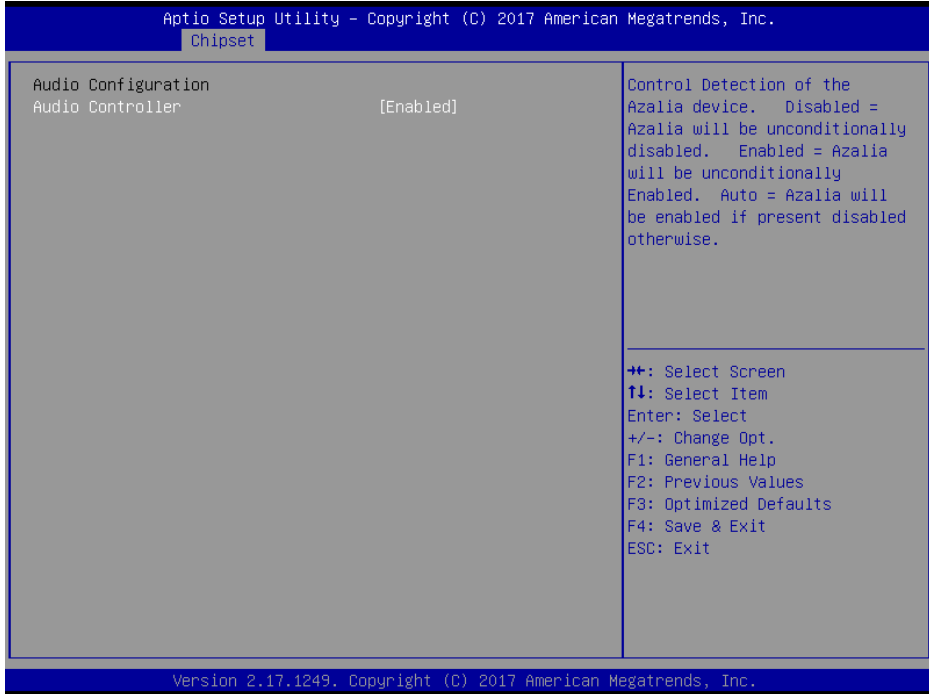

Azalia HD Audio Screen

BIOS Setting	Options	Description/Purpose
Audio Controller	- Disabled - Enabled	Controls the detection of the Azalia device.

Menu Path *Chipset > South Bridge > USB Configuration*

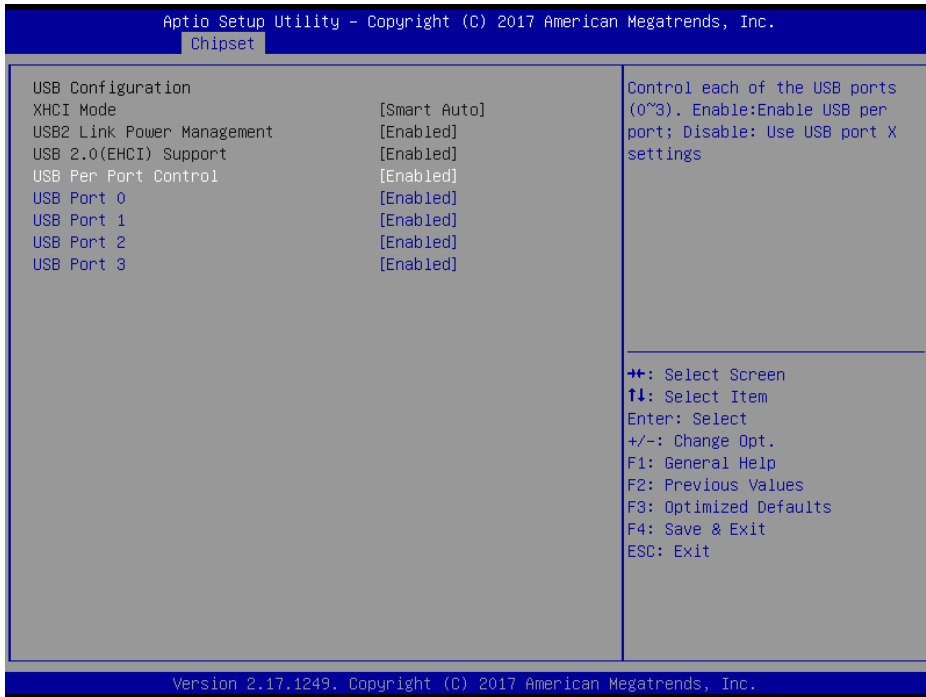

USB Configuration Screen

BIOS Setting	Options	Description/Purpose
XHCI Mode	- Disabled - Enabled - Smart Auto	Selects the operation mode of XHCI controller.
USB2 Link Power Management	- Disabled - Enabled	Enables/Disables USB2 Link Power Management.
USB 2.0(EHCI) Support	- Disabled - Enabled	(Users need to disable XHCI Mode.) Enables Enhanced Host Controller Interface 1 for high-speed USB functions (USB 2.0).
USB Per Port Control	- Disabled - Enabled	Controls each of the USB ports (0~3). <ul style="list-style-type: none"> • Enabled: Enable USB per port • Disabled: Use USB port X settings.
USB Port 0	- Disabled - Enabled	Enables or Disables USB port 0.

BIOS Setting	Options	Description/Purpose
USB Port 1	- Disabled - Enabled	Enables or Disables USB port 1 (USB Hub 1~4).
USB Port 2	- Disabled - Enabled	Enables or Disables USB port 2.
USB Port 3	- Disabled - Enabled	Enables or Disables USB port 3.

5.6 Security

Menu Path *Security*

From the **Security** menu, you are allowed to create, change or clear the administrator password. You will be asked to enter the configured administrator password before you can access the Setup Utility.

By setting an administrator password, you will prevent other users from changing your BIOS settings. You can configure an Administrator password and then configure a user password. An administrator has much more privileges over the settings in the Setup utility than a user. Heed that a user password does not provide access to most of the features in the Setup utility.

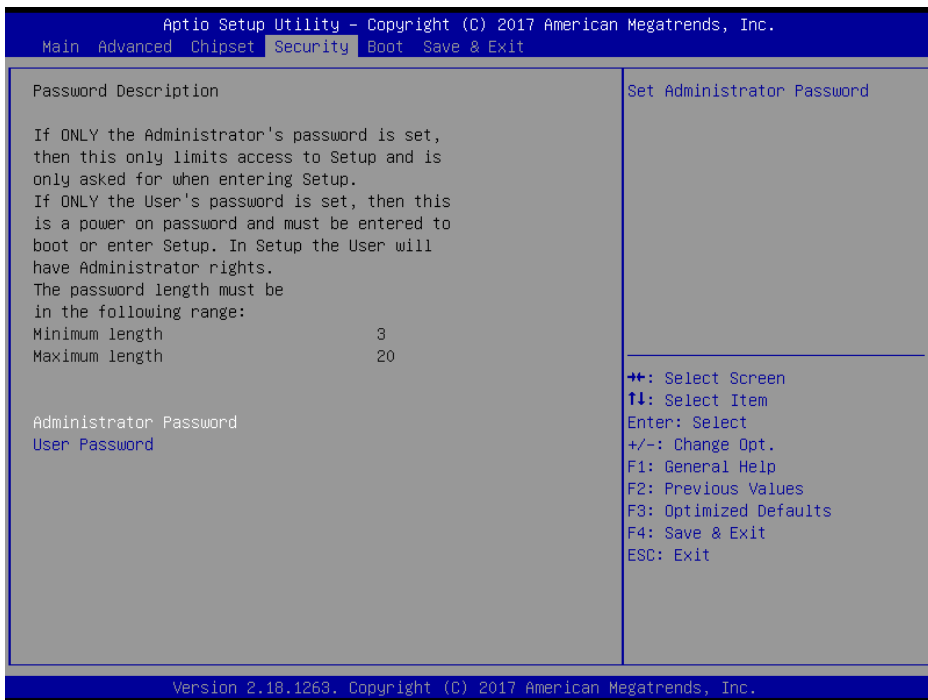

Security Screen

BIOS Setting	Options	Description/Purpose
Administrator Password	Password can be 3-20 alphanumeric characters.	Specifies the administrator password.
User Password	Password can be 3-20 alphanumeric characters.	Specifies the user password.

Create an Administrator or User Password

1. Select the **Administrator Password / User Password** option from the Security menu and press <Enter>, and the password dialog entry box appears.
2. Enter the password you want to create. A password can be 3-20 alphanumeric characters. After you have configured the password, press <Enter> to confirm.
3. Type the new password again and press <Enter>.

Change an Administrator or User Password

1. Select the **Administrator Password / User Password** option from the Security menu and press <Enter>, and the password dialog entry box appears.
2. Select the Administrator Password or User Password that you want to change. A password can be 3-20 alphanumeric characters. After you have changed the password, press <Enter> to confirm.
3. Type the changed password again and press <Enter>.

Remove an Administrator or User Password

1. Select the **Administrator Password / User Password** option from the Security menu and press <Enter>, and the password dialog entry box appears.
2. Select the configured Administrator Password or User Password that you want to delete. Leave the dialog box blank and press <Enter>.
3. Press <Enter> again when the password confirmation box appears.

5.7 Boot

Menu Path *Boot*

This menu provides control items for system boot configuration such as setting setup prompt timeout, enabling/disabling quiet boot and changing the boot order from the available bootable device(s).

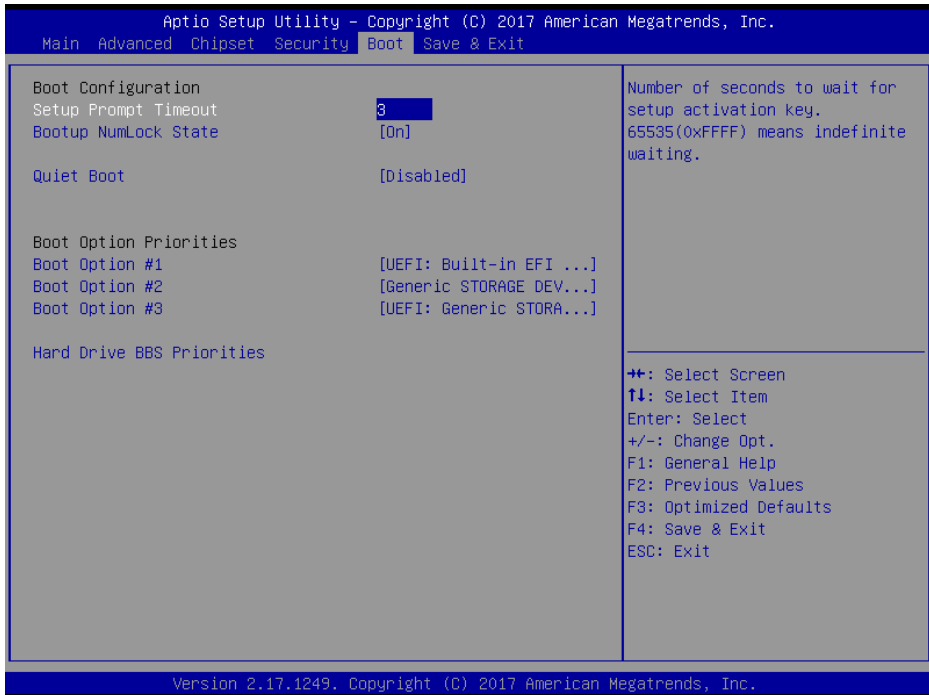

Boot Screen

BIOS Setting	Options	Description/Purpose
Setup Prompt Timeout	Numeric	Number of seconds to wait for setup activation key.
Bootup NumLock State	- On - Off	Specifies the power-on state of the NumLock Key.
Quiet Boot	- Disabled - Enabled	Enables/Disables Quiet Boot Options
Boot Option #1~#n	- [Drive(s)] - Disabled	Allows to set the boot option listed in Hard Drive BBS Priorities.

BIOS Setting	Options	Description/Purpose
Hard Drive BBS Priorities	Sub-Menu	Allow user to select boot order of available drive(s)
Network Drive BBS Priorities	Sub-Menu	Allow user to select boot order of available drive(s)

Boot – Hard Drive BBS Priorities

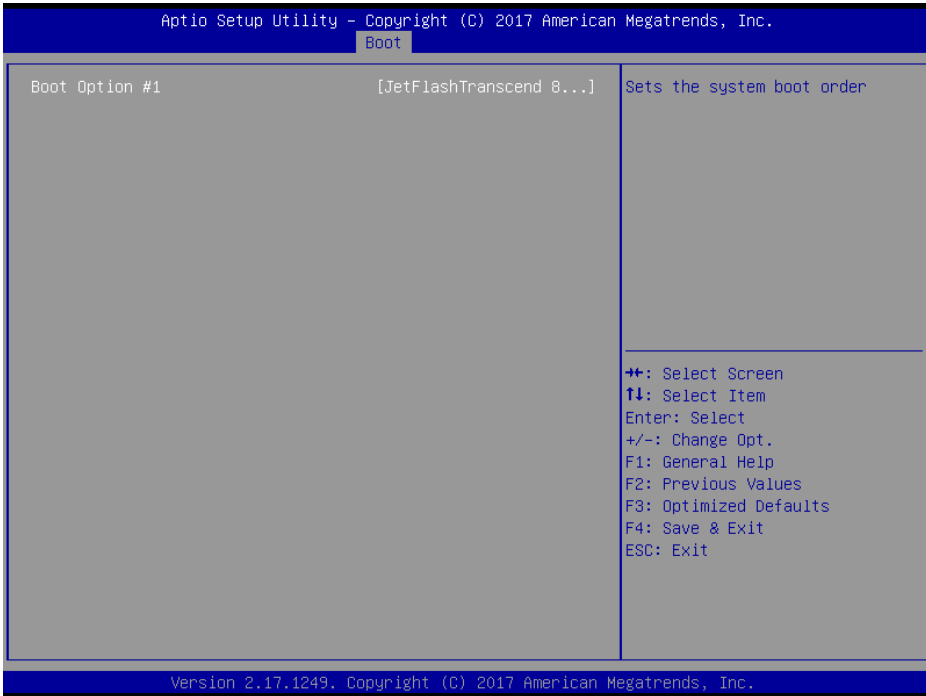

Hard Drive BBS Priorities

BIOS Setting	Options	Description/Purpose
Boot Option #1 - #n	- [Drive(s)] - Disabled	Change the boot order of available drive(s).

Boot – Network Drive BBS Priorities

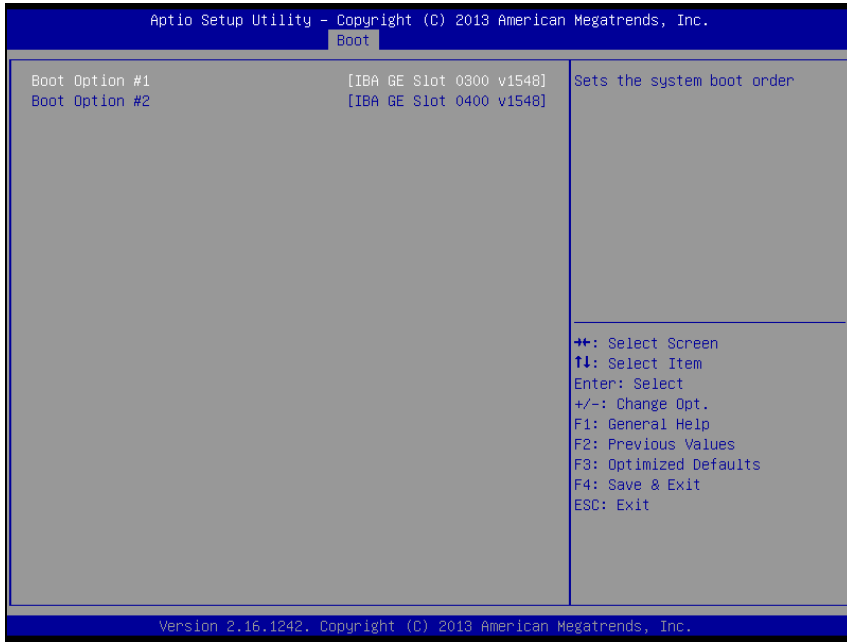

Network Drive BBS Priorities

BIOS Setting	Options	Description/Purpose
Boot Option #1 - #n	- [Drive(s)] - Disabled	Change the boot order of available drive(s).

5.8 Save & Exit

Menu Path *Save & Exit*

The **Save & Exit** allows users to save or discard changed BIOS settings as well as load factory default settings.

Save Changed BIOS Settings

To save and validate the changed BIOS settings, select **Save Changes and Exit** (or press **F4**) from the **Save & Exit** menu to validate the changes and then exit the system. Select **Save Changes and Reset** to validate the changed BIOS settings and then restart the system

Discard Changed BIOS Settings

To cancel the BIOS settings you have previously configured, select **Discard Changes and Exit** from this menu, or simply press **Esc** to exit the BIOS setup. You can also select **Discard Changes and Reset** to discard any changes you have made and restore the factory BIOS defaults.

Load User Defaults

You may simply press **F3** at any time to load the **Optimized Values** which resets all BIOS settings to the factory defaults.

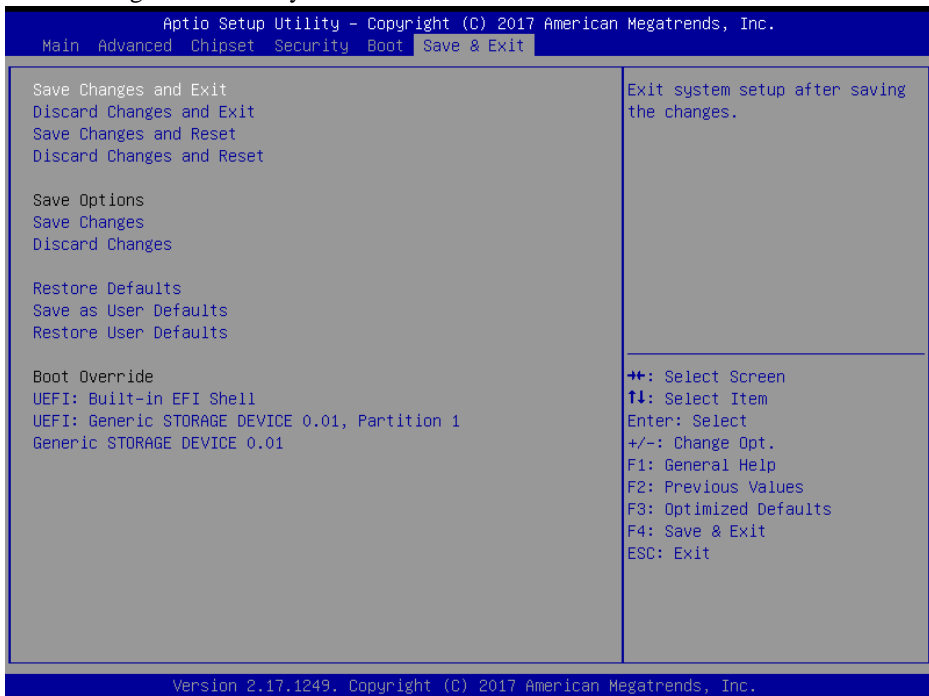

Save & Exit Screen

BIOS Setting	Options	Description/Purpose
Save Changes and Exit	No changeable options	Exits and saves the changes in NVRAM.
Discard Changes and Exit	No changeable options	Exits without saving any changes made in BIOS settings.
Save Changes and Reset	No changeable options	Saves the changes in NVRAM and resets.
Discard Changes and Reset	No changeable options	Resets without saving any changes made in BIOS settings.
Save Changes	No changeable options	Save changes to NVRAM
Discard changes	No changeable options	Discard changes
Restore Defaults	No changeable options	Loads the optimized defaults for BIOS settings.
Save as User Defaults	No changeable options	Save as user default values.
Restore User Defaults	No changeable options	Restores user defaults.
Boot Override	- [Drive(s)]	Forces to boot from selected [drive(s)].

Appendix A System Diagrams

This appendix includes the exploded diagrams of the system and the parts list as well as the part numbers of the KS-1330 system.

- KS-1330 System Exploded Diagram
- KS-1330 Front Cover Exploded Diagram
- KS-1330 PCB Unit Exploded Diagram
- KS-1330 Heatsink Unit Exploded Diagram
- KS-1330 Power Unit Exploded Diagram
- KS-1330 HDD Exploded Diagram
- KS-1330 I/O Exploded Diagram

KS-1330 System Exploded Diagram

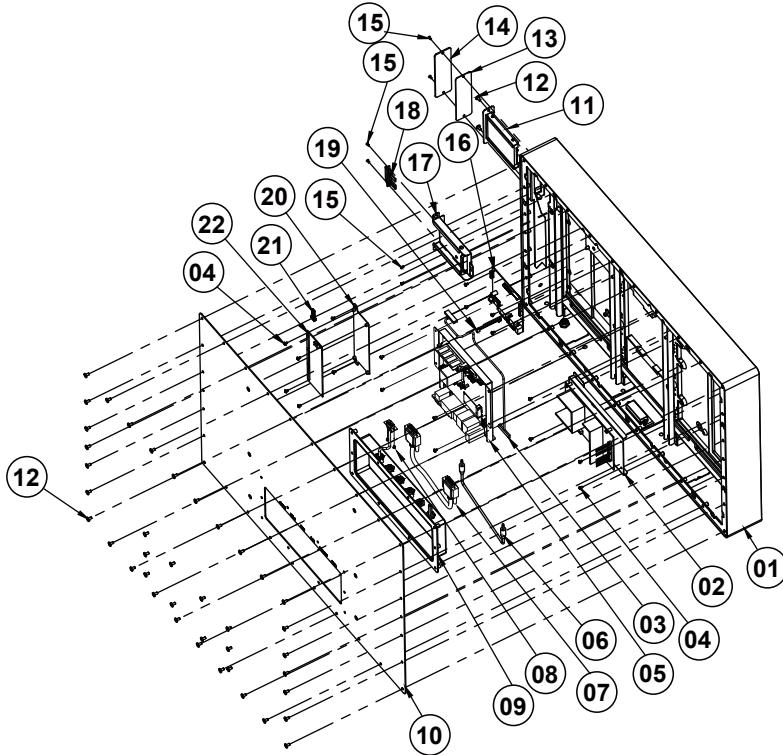

No.	Component Name	P/N No.	Q'ty
1	KS-1330_Front_Unit	N/A	1
2	KS-1330_Power_Unit	N/A	1
3	KS-1330_LVDS_Cable L=400mm	27-020-40808111	1
4	Round Washer Head Screw M3x0.5Px5mm	22-242-30005311	18
5	KS-1330_PCB_Unit	N/A	1
6	KS-1330_Inside_Audio_Cable L=650mm	27-028-40813111	1
7	KS-1330_DVI-Cable L=250mm	27-047-40805111	1
8	Pan Head Screw No.4, L=4mm	22-322-40004311	2
9	KS-1330_IO_Unit	N/A	1
10	KS-1330_Outside_Back_Cover	20-004-02062408	1
11	KS-1330_HDD_UNIT	N/A	1
12	Fillister Head Screw #2 /M4x0.7Px8mm	22-272-40008011	42

KS-1330 System Exploded Diagram

No.	Component Name	P/N No.	Q'ty
13	HDD_Outside_Door_EVA	90-013-15100408	1
14	HDD_Outside_Door	20-047-02061408	1
15	Flat Head Screw #2/ψ 5/ M3x0.5Px6mm	22-212-30006311	6
16	LCD AD_Board	52-152-20658330	1
17	KS-1330_HDD_Holder	20-029-02024408	1
18	SATA_HDD&Power Cable L=390mm	27-012-28408081	1
19	KS-1330_Speaker_Extend_Cable (4p to 2p), L=400mm	27-021-40808111	1
20	32_Cap_Touch_PCB_Holder	20-029-02021408	1
21	KS-1330_Touch_USB_Cable	N/A	1
22	M320H_Touch_PCB	N/A	1

KS-1330 Front Cover Exploded Diagram

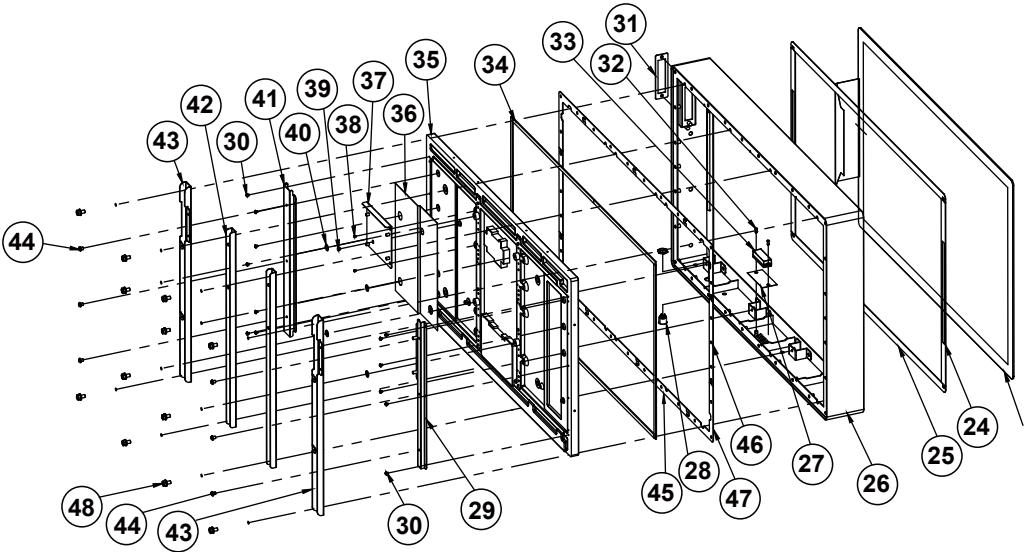

No.	Component Name	P/N No.	Q'ty
23	32" Capacitive Multi-Touch Panel	52-380-07032017	1
24	M320H_Double Faced Adhesive tape-V	34-026-05802408	2
25	M320H_Double Faced Adhesive tape-H	34-026-05801408	2
26	KS-1330_Front_Cover	20-004-02063408	1
27	Speaker_Filem	30-083-02100408	1
28	KS-1330_Power Button Cable, L=600mm	27-019-40812071	1
29	Panel_ADD-L	20-006-02021408	1
30	Round Washer Head Screw #2 / M3x0.5Px4mm	22-235-30004011	13
31	HDD_Door_Rubber	90-013-06300408	1
32	Fillister Head Screw #1 / M3x0.5Px3L, H=5mm	22-272-30008015	2
33	KS-1330_Speaker_Cable, L=70mm	27-021-26902071	1
34	KS-1330_LCD_Rubber	30-013-01100408	6
35	32" TFT LCD Panel (LED Backlight)	52-351-05032002	1
36	Graphite Heat Sink (287.71x208.66x0.19mm)	81-002-38809001	1
37	KS-1330_AD_Board_Holder	20-029-02022408	1

KS-1330 Front Cover Exploded Diagram

No.	Component Name	P/N No.	Q'ty
38	Flat Head Screw #2/ M3x0.5Px4mm	22-215-30004311	2
39	Flat Head Screw M4x0.7Px5mm	22-212-40005011	1
40	Washer_ID6.5mm_OD13mm_T1_Ni	23-312-07010131	4
41	Panel_ADD-R	20-006-02022408	1
42	V_Holder-A	20-029-02027408	2
43	V_Holder-C	20-029-02028408	2
44	Round Head Screw M5x0.8Px6mm	22-232-50006011	6
45	KS-1330_Back_Cover_Rubber-C	90-013-06200408	4
46	KS-1330_Back_Cover_Rubber-B	90-013-06100408	2
47	KS-1330_Back_Cover_Rubber-A	90-013-06500408	4
48	Hex Head With Spring Washer Screw #3 / M6x1.0Px12mm	22-251-60012011	12

KS-1330 PCB Unit Exploded Diagram

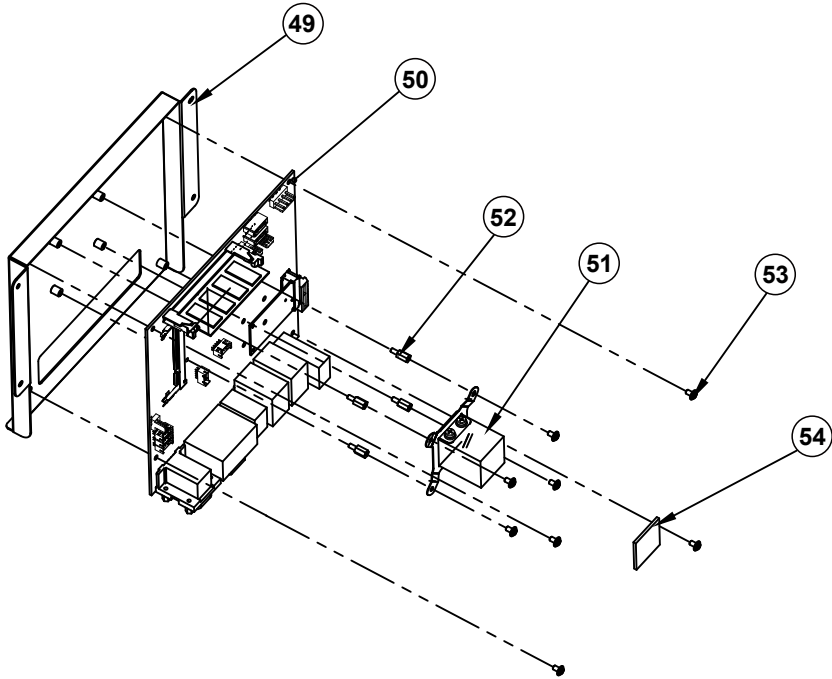

No.	Component Name	P/N No.	Q'ty
49	KS-1330_PCB_Holder	20-029-02025408	1
50	BM-0962	BM-0962	1
51	KF-1330_Heatsink_Unit	N/A	1
52	Hex Cu Boss, M3x0.5Px6L, H=8mm	22-290-30008051	4
53	Round Washer Head Screw, M3x0.5Px5mm	22-242-30005311	8
54	Thermal Interface Pads, 27x27x1.5mm	21-006-82721001	1

KS-1330 Heatsink Unit Exploded Diagram

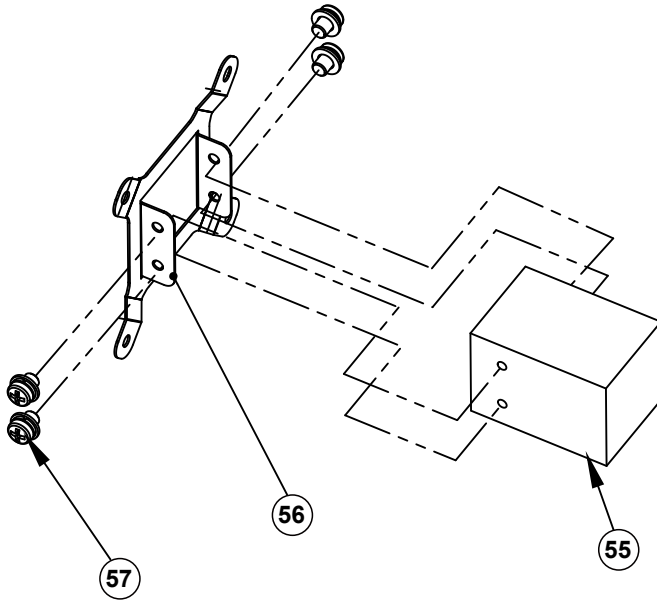

No.	Component Name	P/N No.	Q'ty
55	KS-1330 Heatsink (40x27x27mm)	21-002-14027003	1
56	KS-1330_Heatsink_holder	80-029-07001408	1
57	Round Head With Spring Washer Screw M3x0.5Px5mm	22-232-30060011	4

KS-1330 Power Unit Exploded Diagram

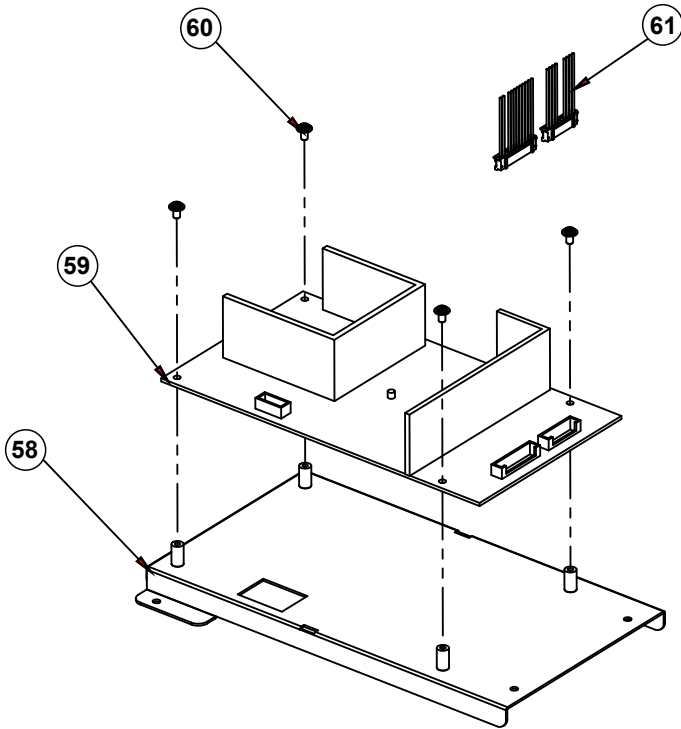

No.	Component Name	P/N No.	Q'ty
58	KS-1330_Power_Holder	20-029-02026408	1
59	WPI 164W Power Supply	52-001-34180820	1
60	Round Washer Head Screw, M3x0.5Px5mm	22-242-30005311	4
61	KS-1330_DC_Out_Cable	27-060-40816111	1

KS-1330 HDD Exploded Diagram

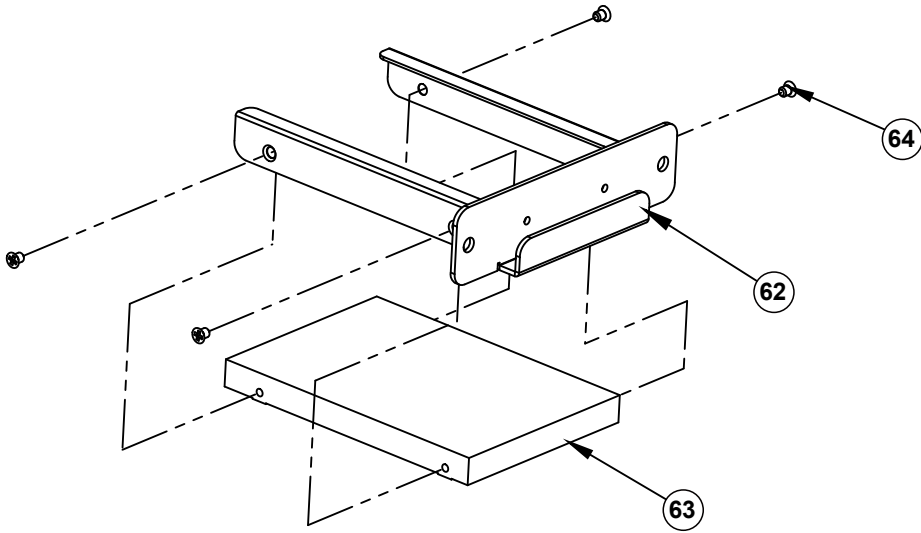

No.	Component Name	P/N No.	Q'ty
62	KS-1330_HDD_Tray	20-054-02021408	1
63	2.5" SATA HDD	See Order	1
64	Flat Head Screw #2/ M3x0.5Px4mm	22-215-30004311	4

KS-1330 I/O Exploded Diagram

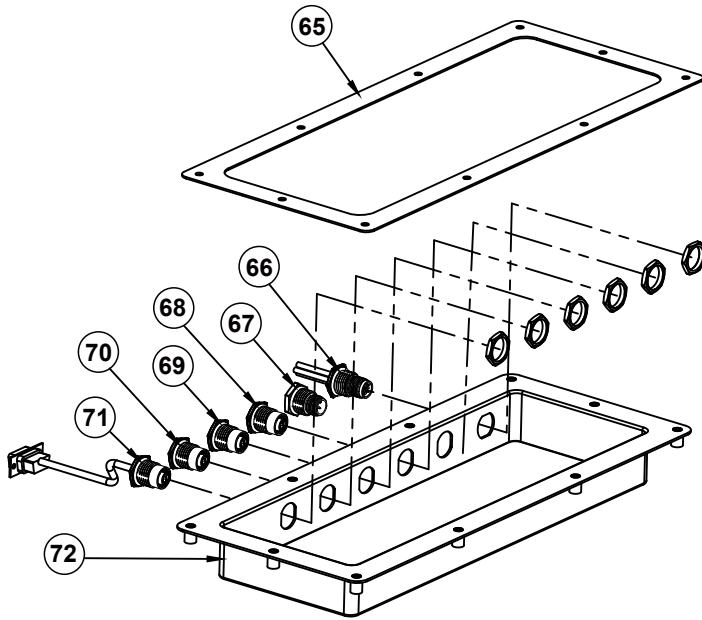

No.	Component Name	P/N No.	Q'ty
65	KS-1330_IO_Rubber	90-013-06400408	1
66	KS-1330_Power_cable, L=400mm	27-012-40808071	1
67	KS-1330_Audio_cable, 3.5mm, L=180mm	27-023-40804111	1
68	KS-1330_LAN_Cable, L=160mm	27-026-40804111	1
69	KS-1330_USB 3 Cable, L=160mm	27-006-40804111	1
70	KS-1330_USB 1 Cable, L=140mm	27-006-40803111	1
71	KS-1330_COM_Cable, L=150mm	27-024-40803111	1
72	KS-1330_IO_Cover	20-004-02061408	1

Appendix B Technical Summary

This appendix will give you a brief introduction of the allocation maps for the system resources.

The following topics are included:

- System Block Diagram
- Interrupt Map
- I/O Map
- Memory Map
- Configuring WatchDog Timer
- Flash BIOS Update

System Block Diagram

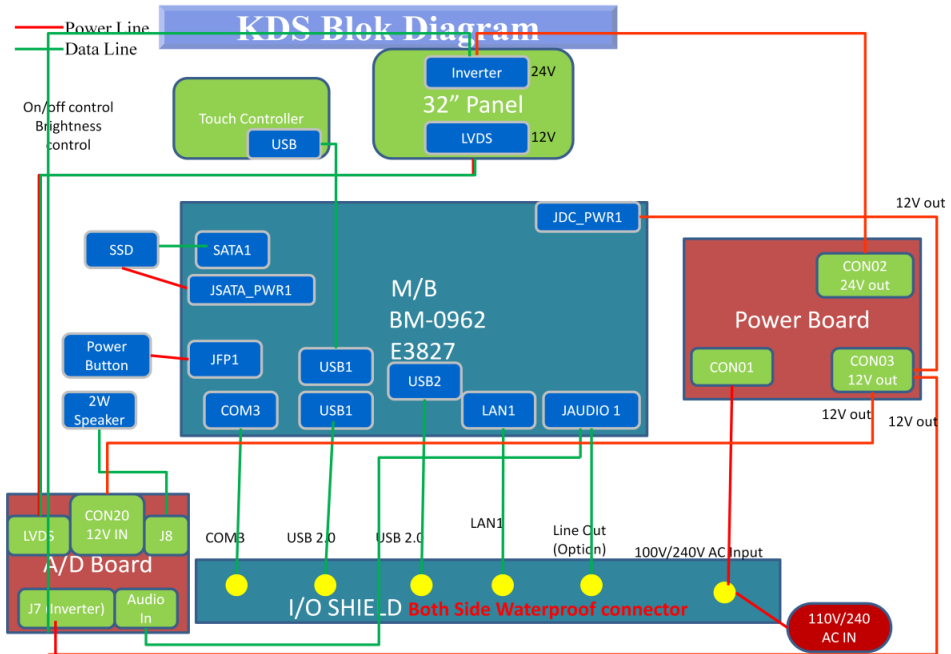

Interrupt Map

IRQ	ASSIGNMENT
0	System timer
3	Communications Port (COM2)
4	Communications Port (COM1)
5	Intel® Atom™/Celeron®/Pentium® Processor Platform Control Unit - SMBus Port - 0F12
7	Communications Port (COM3)
8	High precision event timer
10	Communications Port (COM4)
16	Intel® Atom™/Celeron®/Pentium® Processor PCI Express - Root Port 1 - 0F48
17	Intel® Atom™/Celeron®/Pentium® Processor PCI Express - Root Port 2 - 0F4A
18	Intel® Atom™/Celeron®/Pentium® Processor PCI Express - Root Port 3 - 0F4C
19	Intel® Atom™/Celeron®/Pentium® Processor AHCI - 0F23
19	Intel® Atom™/Celeron®/Pentium® Processor PCI Express - Root Port 4 - 0F4E
22	High Definition Audio Controller
23	Intel® Atom™/Celeron®/Pentium® Processor EHCI USB - 0F34
42	Intel Device
43	Intel Device
81	Microsoft ACPI-Compliant System
82	Microsoft ACPI-Compliant System
83	Microsoft ACPI-Compliant System
84	Microsoft ACPI-Compliant System
85	Microsoft ACPI-Compliant System

IRQ	ASSIGNMENT
86	Microsoft ACPI-Compliant System
87	Microsoft ACPI-Compliant System
88	Microsoft ACPI-Compliant System
89	Microsoft ACPI-Compliant System
90	Microsoft ACPI-Compliant System
91	Microsoft ACPI-Compliant System
92	Microsoft ACPI-Compliant System
93	Microsoft ACPI-Compliant System
94	Microsoft ACPI-Compliant System
95	Microsoft ACPI-Compliant System
96	Microsoft ACPI-Compliant System
97	Microsoft ACPI-Compliant System
98	Microsoft ACPI-Compliant System
99	Microsoft ACPI-Compliant System
100	Microsoft ACPI-Compliant System
101	Microsoft ACPI-Compliant System
102	Microsoft ACPI-Compliant System
103	Microsoft ACPI-Compliant System
104	Microsoft ACPI-Compliant System
105	Microsoft ACPI-Compliant System
106	Microsoft ACPI-Compliant System
107	Microsoft ACPI-Compliant System
108	Microsoft ACPI-Compliant System
109	Microsoft ACPI-Compliant System
110	Microsoft ACPI-Compliant System
111	Microsoft ACPI-Compliant System
112	Microsoft ACPI-Compliant System

IRQ	ASSIGNMENT
113	Microsoft ACPI-Compliant System
114	Microsoft ACPI-Compliant System
115	Microsoft ACPI-Compliant System
116	Microsoft ACPI-Compliant System
117	Microsoft ACPI-Compliant System
118	Microsoft ACPI-Compliant System
119	Microsoft ACPI-Compliant System
120	Microsoft ACPI-Compliant System
121	Microsoft ACPI-Compliant System
122	Microsoft ACPI-Compliant System
123	Microsoft ACPI-Compliant System
124	Microsoft ACPI-Compliant System
125	Microsoft ACPI-Compliant System
126	Microsoft ACPI-Compliant System
127	Microsoft ACPI-Compliant System
128	Microsoft ACPI-Compliant System
129	Microsoft ACPI-Compliant System
130	Microsoft ACPI-Compliant System
131	Microsoft ACPI-Compliant System
132	Microsoft ACPI-Compliant System
133	Microsoft ACPI-Compliant System
134	Microsoft ACPI-Compliant System
135	Microsoft ACPI-Compliant System
136	Microsoft ACPI-Compliant System
137	Microsoft ACPI-Compliant System
138	Microsoft ACPI-Compliant System
139	Microsoft ACPI-Compliant System

IRQ	ASSIGNMENT
140	Microsoft ACPI-Compliant System
141	Microsoft ACPI-Compliant System
142	Microsoft ACPI-Compliant System
143	Microsoft ACPI-Compliant System
144	Microsoft ACPI-Compliant System
145	Microsoft ACPI-Compliant System
146	Microsoft ACPI-Compliant System
147	Microsoft ACPI-Compliant System
148	Microsoft ACPI-Compliant System
149	Microsoft ACPI-Compliant System
150	Microsoft ACPI-Compliant System
151	Microsoft ACPI-Compliant System
152	Microsoft ACPI-Compliant System
153	Microsoft ACPI-Compliant System
154	Microsoft ACPI-Compliant System
155	Microsoft ACPI-Compliant System
156	Microsoft ACPI-Compliant System
157	Microsoft ACPI-Compliant System
158	Microsoft ACPI-Compliant System
159	Microsoft ACPI-Compliant System
160	Microsoft ACPI-Compliant System
161	Microsoft ACPI-Compliant System
162	Microsoft ACPI-Compliant System
163	Microsoft ACPI-Compliant System
164	Microsoft ACPI-Compliant System
165	Microsoft ACPI-Compliant System
166	Microsoft ACPI-Compliant System

IRQ	ASSIGNMENT
167	Microsoft ACPI-Compliant System
168	Microsoft ACPI-Compliant System
169	Microsoft ACPI-Compliant System
170	Microsoft ACPI-Compliant System
171	Microsoft ACPI-Compliant System
172	Microsoft ACPI-Compliant System
173	Microsoft ACPI-Compliant System
174	Microsoft ACPI-Compliant System
175	Microsoft ACPI-Compliant System
176	Microsoft ACPI-Compliant System
177	Microsoft ACPI-Compliant System
178	Microsoft ACPI-Compliant System
179	Microsoft ACPI-Compliant System
180	Microsoft ACPI-Compliant System
181	Microsoft ACPI-Compliant System
182	Microsoft ACPI-Compliant System
183	Microsoft ACPI-Compliant System
184	Microsoft ACPI-Compliant System
185	Microsoft ACPI-Compliant System
186	Microsoft ACPI-Compliant System
187	Microsoft ACPI-Compliant System
188	Microsoft ACPI-Compliant System
189	Microsoft ACPI-Compliant System
190	Microsoft ACPI-Compliant System
4294967281	Intel® I211 Gigabit Network Connection
4294967282	Intel® I211 Gigabit Network Connection
4294967283	Intel® I211 Gigabit Network Connection

IRQ	ASSIGNMENT
4294967284	Intel® I211 Gigabit Network Connection
4294967285	Intel® I211 Gigabit Network Connection
4294967286	Intel® I211 Gigabit Network Connection
4294967287	Intel® I210 Gigabit Network Connection
4294967288	Intel® I210 Gigabit Network Connection
4294967289	Intel® I210 Gigabit Network Connection
4294967290	Intel® I210 Gigabit Network Connection
4294967291	Intel® I210 Gigabit Network Connection
4294967292	Intel® I210 Gigabit Network Connection
4294967293	Intel® Trusted Execution Engine Interface
4294967294	Intel® Atom™ Processor E3800 Series/Intel® Celeron® Processor N2920/J1900

I/O MAP

I/O MAP	ASSIGNMENT
0x00000000-0x0000006F	PCI bus
0x00000020-0x00000021	Programmable interrupt controller
0x00000024-0x00000025	Programmable interrupt controller
0x00000028-0x00000029	Programmable interrupt controller
0x0000002C-0x0000002D	Programmable interrupt controller
0x0000002E-0x0000002F	Motherboard resources
0x00000030-0x00000031	Programmable interrupt controller
0x00000034-0x00000035	Programmable interrupt controller
0x00000038-0x00000039	Programmable interrupt controller
0x0000003C-0x0000003D	Programmable interrupt controller
0x00000040-0x00000043	System timer
0x0000004E-0x0000004F	Motherboard resources
0x00000050-0x00000053	System timer
0x00000061-0x00000061	Motherboard resources
0x00000063-0x00000063	Motherboard resources
0x00000065-0x00000065	Motherboard resources
0x00000067-0x00000067	Motherboard resources
0x00000070-0x00000077	System CMOS/real time clock
0x00000070-0x00000077	Motherboard resources
0x00000078-0x000000CF	PCI bus
0x00000080-0x0000008F	Motherboard resources
0x00000092-0x00000092	Motherboard resources

I/O MAP	ASSIGNMENT
0x000000A0-0x000000A1	Programmable interrupt controller
0x000000A4-0x000000A5	Programmable interrupt controller
0x000000A8-0x000000A9	Programmable interrupt controller
0x000000AC-0x000000AD	Programmable interrupt controller
0x000000B0-0x000000B1	Programmable interrupt controller
0x000000B2-0x000000B3	Motherboard resources
0x000000B4-0x000000B5	Programmable interrupt controller
0x000000B8-0x000000B9	Programmable interrupt controller
0x000000BC-0x000000BD	Programmable interrupt controller
0x000002E8-0x000002EF	Communications Port (COM4)
0x000002F8-0x000002FF	Communications Port (COM2)
0x000003B0-0x000003BB	Intel® Atom™ Processor E3800 Series/Intel® Celeron® Processor N2920/J1900
0x000003C0-0x000003DF	Intel® Atom™ Processor E3800 Series/Intel® Celeron® Processor N2920/J1900
0x000003E8-0x000003EF	Communications Port (COM3)
0x000003F8-0x000003FF	Communications Port (COM1)
0x00000400-0x0000047F	Motherboard resources
0x000004D0-0x000004D1	Programmable interrupt controller
0x00000500-0x000005FE	Motherboard resources
0x00000600-0x0000061F	Motherboard resources
0x00000680-0x0000069F	Motherboard resources
0x00000A00-0x00000A0F	Motherboard resources
0x00000A10-0x00000A1F	Motherboard resources

I/O MAP	ASSIGNMENT
0x0000A20-0x0000A2F	Motherboard resources
0x0000D00-0x0000FFFF	PCI bus
0x0000C000-0x0000CFFF	Intel® Atom™/Celeron®/Pentium® Processor PCI Express - Root Port 4 - 0F4E
0x0000D000-0x0000DFFF	Intel® Atom™/Celeron®/Pentium® Processor PCI Express - Root Port 3 - 0F4C
0x0000E000-0x0000E01F	Intel® Atom™/Celeron®/Pentium® Processor Platform Control Unit - SMBus Port - 0F12
0x0000E020-0x0000E03F	Intel® Atom™/Celeron®/Pentium® Processor AHCI - 0F23
0x0000E040-0x0000E043	Intel® Atom™/Celeron®/Pentium® Processor AHCI - 0F23
0x0000E050-0x0000E057	Intel® Atom™/Celeron®/Pentium® Processor AHCI - 0F23
0x0000E060-0x0000E063	Intel® Atom™/Celeron®/Pentium® Processor AHCI - 0F23
0x0000E070-0x0000E077	Intel® Atom™/Celeron®/Pentium® Processor AHCI - 0F23
0x0000E080-0x0000E087	Intel® Atom™ Processor E3800 Series/Intel® Celeron® Processor N2920/J1900

Memory Map

MEMORY MAP	ASSIGNMENT
0xFF000000-0xFFFFFFFF	Intel® 82802 Firmware Hub Device
0x90810000-0x908107FF	Intel® Atom™/Celeron®/Pentium® Processor AHCI - 0F23
0x90700000-0x9077FFFF	Intel® I210 Gigabit Network Connection
0x90700000-0x9077FFFF	Intel® Atom™/Celeron®/Pentium® Processor PCI Express - Root Port 3 - 0F4C
0x90780000-0x90783FFF	Intel® I210 Gigabit Network Connection
0x9081C000-0x9081FFFF	Intel Device
0x90000000-0x903FFFFF	Intel® Atom™ Processor E3800 Series/Intel® Celeron® Processor N2920/J1900
0x80000000-0x8FFFFFFF	Intel® Atom™ Processor E3800 Series/Intel® Celeron® Processor N2920/J1900
0x80000000-0x8FFFFFFF	PCI bus
0x90814000-0x90817FFF	Intel Device
0x90600000-0x9061FFFF	Intel® I211 Gigabit Network Connection
0x90600000-0x9061FFFF	Intel® Atom™/Celeron®/Pentium® Processor PCI Express - Root Port 4 - 0F4E
0x90620000-0x90623FFF	Intel® I211 Gigabit Network Connection
0x9080E000-0x9080E3FF	Intel® Atom™/Celeron®/Pentium® Processor EHCI USB - 0F34
0xFED00000-0xFED003FF	High precision event timer
0x90804000-0x90807FFF	High Definition Audio Controller
0xE0000000-0xEFFFFFFF	Motherboard resources

MEMORY MAP	ASSIGNMENT
0xFED01000-0xFED01FFF	Motherboard resources
0xFED03000-0xFED03FFF	Motherboard resources
0xFED04000-0xFED04FFF	Motherboard resources
0xFED08000-0xFED08FFF	Motherboard resources
0xFED1C000-0xFED1CFFF	Motherboard resources
0xFEE00000-0xFEEFFFFFFF	Motherboard resources
0xFEFE00000-0xFEFFFFFFF	Motherboard resources
0x9080C000-0x9080C01F	Intel® Atom™/Celeron®/Pentium® Processor Platform Control Unit - SMBus Port - 0F12
0x90500000-0x905FFFFFFF	Intel® Trusted Execution Engine Interface
0x90400000-0x904FFFFFFF	Intel® Trusted Execution Engine Interface
0xA0000-0xBFFFF	Intel® Atom™ Processor E3800 Series/Intel® Celeron® Processor N2920/J1900
0xA0000-0xBFFFF	PCI bus
0xC0000-0xDFFFF	PCI bus
0xE0000-0xFFFFF	PCI bus

Configuring WatchDog Timer

The I/O port address of the watchdog timer is 2E (hex) and 2F (hex). 2E (hex) is the address port. 2F (hex) is the data port. User must first assign the address of register by writing address value into address port 2E (hex), then write/read data to/from the assigned register through data port 2F (hex).

Configuration Sequence

To program F81866 configuration registers, the following configuration sequence must be followed:

(1) Enter the extended function mode

To place the chip into the Extended Function Mode, two successive writes of 0x87 must be applied to Extended Function Enable Registers (EFERs, i.e. 2Eh or 4Eh).

(2) Configure the configuration registers

The chip selects the Logical Device and activates the desired Logical Devices through Extended Function Index Register (EFIR) and Extended Function Data Register (EFDR). The EFIR is located at the same address as the EFER, and the EFDR is located at address (EFIR+1). First, write the Logical Device Number (i.e. 0x07) to the EFIR and then write the number of the desired Logical Device to the EFDR. If accessing the Chip (Global) Control Registers, this step is not required. Secondly, write the address of the desired configuration register within the Logical Device to the EFIR and then write (or read) the desired configuration register through the EFDR.

(3) Exit the extended function mode

To exit the Extended Function Mode, writing 0xAA to the EFER is required. Once the chip exits the Extended Function Mode, it is in the normal running mode and is ready to enter the configuration mode.

Code example for watch dog timer

Enable watchdog timer and set timeout interval to 30 seconds.

```

;----- Enter to extended function mode -----
mov          dx,          2eh
mov          al,          87h
out          dx,          al
out          dx,          al
;----- Select Logical Device 7 of watchdog timer
-----
mov          al,          07h
out          dx,          al
inc          dx
mov          al,          07h
out          dx,          al
;----- Enable Watch dog feature
-----
mov          al,          030h
out          dx,          al
inc          dx
mov          al,          01h
out          dx,          al
;----- Clear WatchDog Timeout
State-----
dec          dx
mov          al,          0f5h
out          dx,          al
inc          dx
in           al,          dx
and          al,          40h
out          dx,          al
;----- Set timeout interval as 30seconds and start counting
-----
dec          dx
mov          al,          0f6h
out          dx,          al
inc          dx
mov          al,          1Eh
out          dx,          al
;----- Enable Watch
PME-----
dec          dx
mov          al,          0FAh
out          dx,          al

```

inc	dx	
in	al,	dx
and	al,	51h
out	dx,	al
;----- Set second as counting unit		

dec	dx	
mov	al,	0F5h
out	dx,	al
inc	dx	
in	al,	dx
and	al,	31h
out	dx,	al
;----- Exit the extended function mode		

dec	dx	
mov	al,	0aah
out	dx,	al

Flash BIOS Update

I. Prerequisites

- 1 Prepare a bootable media (e.g. USB storage device) which can boot system to DOS prompt.
- 2 Download and save the BIOS file (e.g. 13300PI1.bin) to the storage device.
- 3 Copy AMI flash utility – AFUDOS.exe (V5.06.01) into the storage device. The utility and BIOS file should be saved to the same path.
- 4 Make sure the targeted system can first boot to the EFI shell environment.
 - (1) Connect the USB storage device.
 - (2) Turn on the computer and press <Esc> or key during boot to enter BIOS Setup.
 - (3) The system will go into the BIOS setup menu.
 - (4) Select [Hard Drive BBS Priorities] and set the USB bootable device as the 1st boot device.
 - (5) Press <F4> to save the configuration and restart the system.



II. AFUDOS Command for System BIOS Update

AFUDOS.exe is the AMI firmware update utility; the command line is shown as below:

AFUDOS <ROM File Name> [option1] [option2]...

You can type **AFUDOS /?** to see all the definition of each control options. The recommended options for BIOS ROM update consist of following parameters:

/P: program main BIOS image

/B: program Boot Block

/N: program NVRAM

/X: don't check ROM ID

III. BIOS Update Procedure

- 1 Use the bootable USB device to boot up system into the MS-DOS command prompt.
- 2 Type "**AFUDOS 1330xxxx.bin /p /b /n /x**" and press Enter to start the flash procedure. (xxxx means the BIOS revision part, e.g. 0PI1...)
- 3 During the update procedure, you will see the BIOS update process status and the percentage it has been updated. **Beware!** Do not turn off system power or reset your computer if the whole update procedure is not completed yet, or it may crash the BIOS ROM and the system will be unable to boot up next time.
- 4 After BIOS update procedure is completed, the following messages will be shown:

```
C:\AFU>afudos.exe 13300P11.BIN /p /b /n /x
-----+-----
|                               AMI Firmware Update Utility  v5.06.01                               |
|                               Copyright (C)2014 American Megatrends Inc. All Rights Reserved.       |
|-----+-----|
Reading flash ..... done
- ME Data Size checking . ok
- FFS checksums ..... ok
Erasing Boot Block ..... done
Updating Boot Block ..... done
Verifying Boot Block ..... done
Erasing Main Block ..... done
Updating Main Block ..... done
Verifying Main Block ..... done
Erasing NURAM Block ..... done
Updating NURAM Block ..... done
Verifying NURAM Block ..... done

C:\AFU>
C:\AFU>_
```

- 5 Restart the system and boot up with the new BIOS configuration.
- 6 The BIOS Update is completed after the system is restarted.
- 7 Reboot the system and verify if the BIOS version shown on the initialization screen has been updated.

