

# PA-3350

## Quick Reference Guide

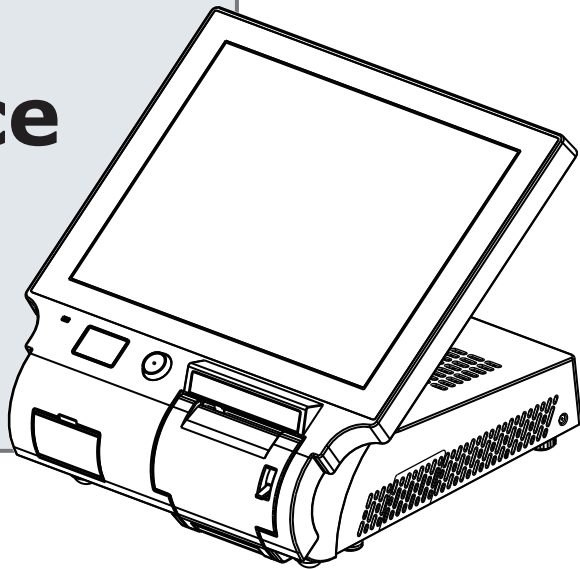

Ver. Q1

All Rights Reserved. Copyright 2014

## Packing Checklist

If you discover any item below damaged or lost, please contact your vendor.

- PA-3350 x1
- This Quick Reference Guide x1
- AC Power Adaptor x1
- Manual/Driver CD x1

## Specifications

### System

CPU Support	Intel® 2 <sup>nd</sup> Gen. Core™ i3-2120 3.3 GHz, L2 Cache-3MB Intel® Pentium® G850 2.9GHz, L2 Cache-3MB Intel® Celeron® G530 2.4GHz, L2 Cache-2MB
-------------	---

Chipset	Intel® H61
Memory	1 x DDR3 SO-DIMM slot (up to 4GB)
O.S. Support	Windows POSReady 7/2009, WES 7/2009
BIOS	AMI SPI BIOS
Audio	1 x 2W speaker
Power Adapter	120~150 Watt DC-in
System Weight	7.5 kg
Dimension (WxHxD)	369 x 301 x 356 mm
Certificate	FCC/CE

### Storage

HDD	1 x 2.5" SATA HDD
SD/MMC	1 x SATA half-slim SSD

### I/O Ports

USB	5 x USB 2.0 (one on the front bezel)
Serial Port	2 x DB-9 (COM2/3), 1 x RJ45 (COM1), 5V/12V selectable
PS/2	1 x PS/2 port
LAN	1 x RJ45
VGA	2 x DB-15 VGA interface

### Display

LCD & Tilt Angle	15" TFT XGA; 30~40°
Max. Resolution	1024 x 768
Brightness	250 cd/m <sup>2</sup>
Touch Screen	Flat 5-wire analog resistive Projected-capacitive (Optional)

### Environment

Operating Temp.	Operating: 0~35°C; Storage: -20~60°C
Humidity	20 ~ 90%

## System View

Front View

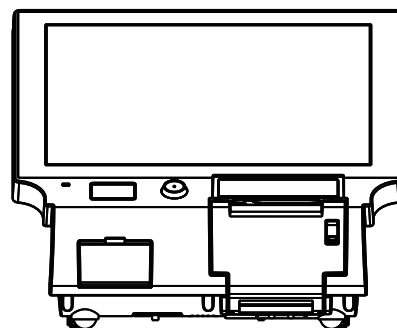

Rear View

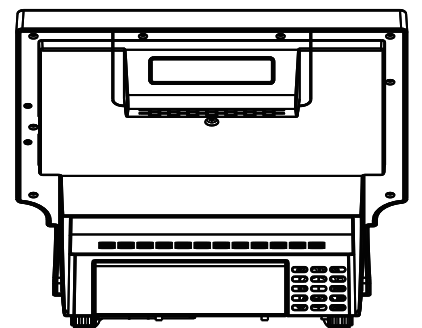

Side View

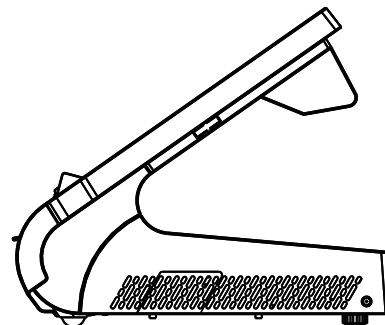

Quarter View

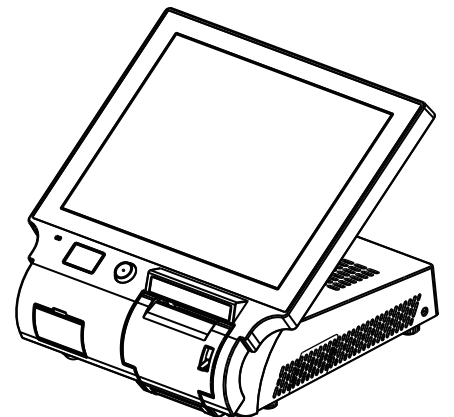

I/O View

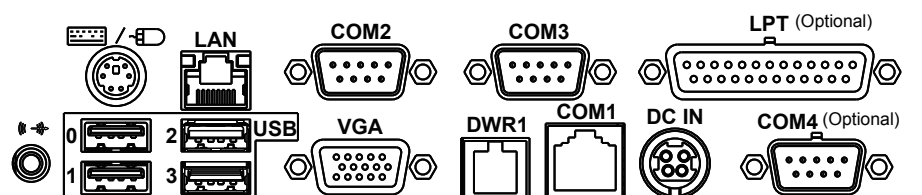

# PA-3350

## The Highly Integrated 15" POS Terminal

### Easy Maintenance

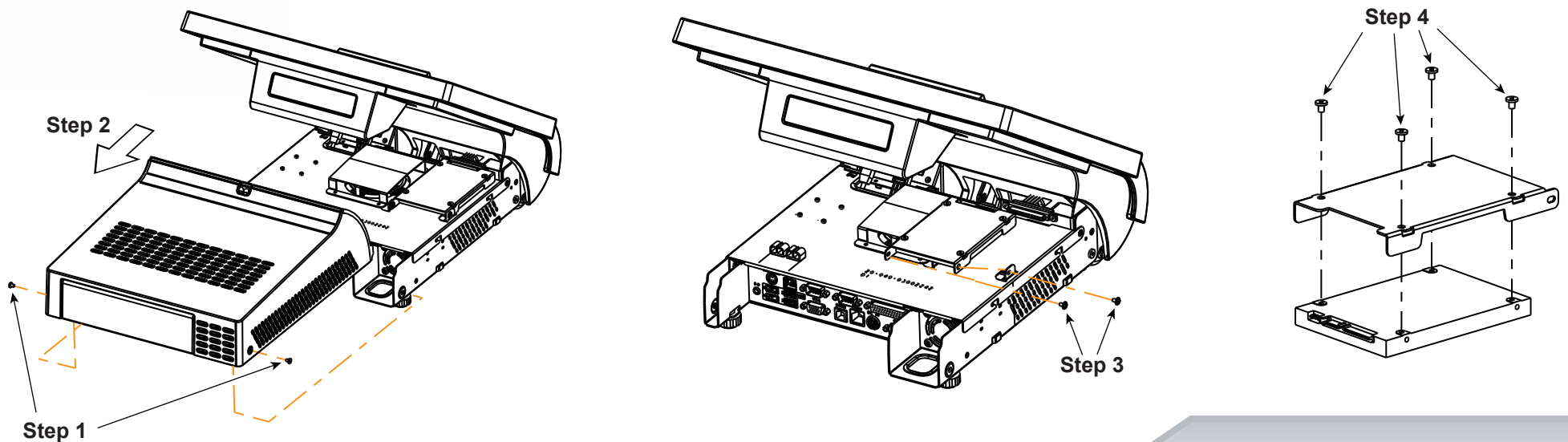

### Jumper Setting

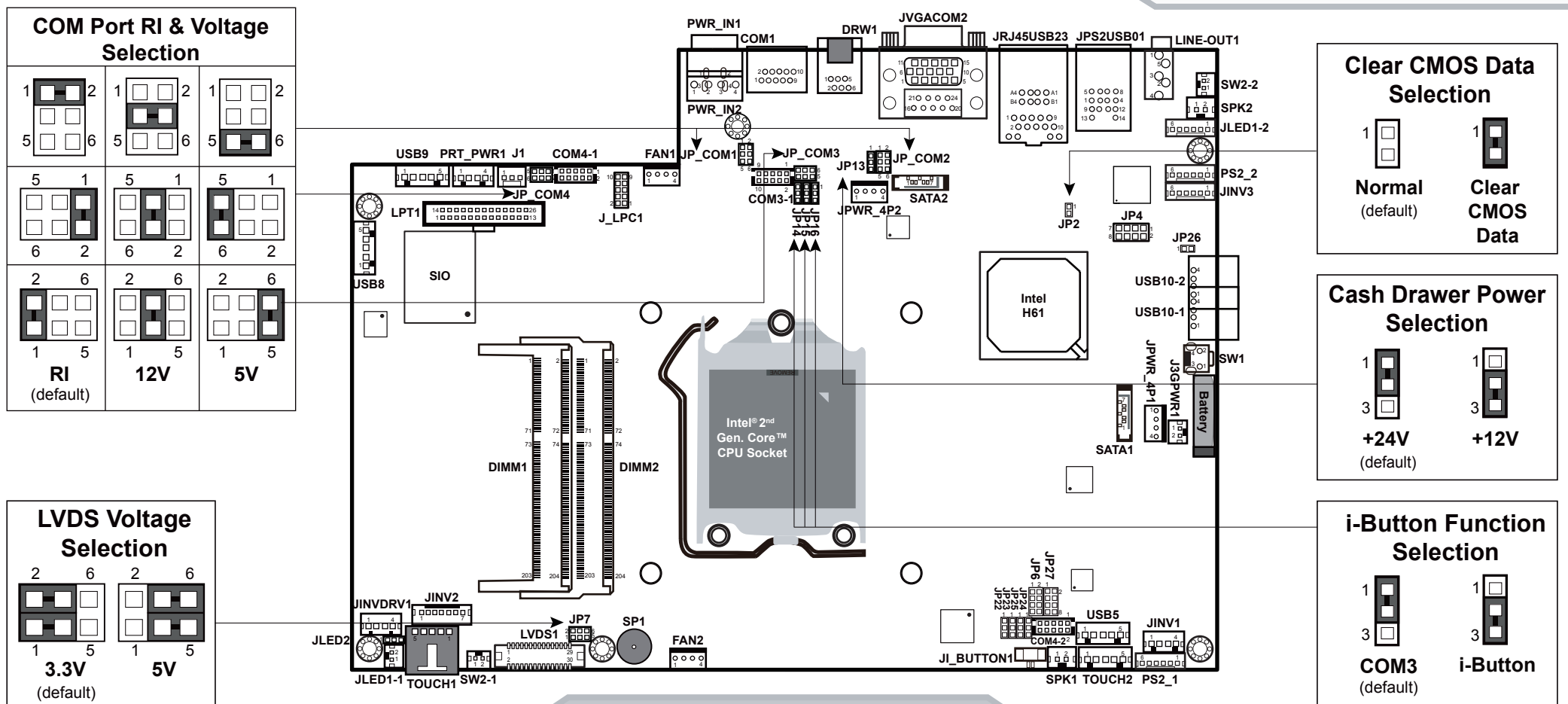

### Safety Precaution

The following messages are reminders for safety on how to protect your systems from damages and to extend a long life of the system.

#### 1. Check the Cable Voltage

- Make sure the range of operating voltage between AC 100V ~ 240V. Otherwise, the system could be damaged.

#### 2. Environmental Conditions

- Place your PA-3350 on a sturdy, level surface. Be sure to allow enough space to have easy access around the system.
- Avoid extremely hot or cold place to install the system.
- Avoid exposure to sunlight for a long period of time or in an airtight space.
- Avoid the system from any heating device or using it outdoors in a cold winter day.
- Bear in mind that the operating ambient temperature is from 0 ~ 35°C (32 ~ 95°F).
- Avoid moving the system rapidly from a hot place to a cold place and vice versa because condensation may come from inside of the system.
- Place PA-3350 in strong vibration(s) may cause hard disk failure.
- Don't place the system close to any radio active device in case of signal interference.

#### 3. Handling

- If the system isn't fully in DOS mode, adjust BIOS setting as the instruction: Advanced Chipset Feature => Boot display => choose "LFP".
- Avoid putting heavy objects on top of the system.
- Don't turn the system upside down. This may cause the hard drive to malfunction.

- Don't allow foreign objects to fall into this product.
- If water or other liquid spills into this product, unplug the power cord immediately.

#### 4. Good Care

- When the outside of the case is stained, remove the stain with a neutral washing agent with a dry cloth.
- Never use strong agents such as benzene and thinner to clean the system. If heavy stains are present, moisten a cloth with diluted neutral washing agent or with alcohol and then wipe thoroughly with a dry cloth.
- If dust has been accumulated on the outside, remove it by using a special made vacuum cleaner for computers.
- Don't contact the surface of capacitive touch before entering your operation system, or capacitive touch may have position problems for electrostatics interface.
- Don't exchange the M/B battery by yourself or serious damage may incur.

**CAUTION!** Danger of explosion if battery is incorrectly replaced. Replace only with the same or equivalent type recommended by the manufacturer. Dispose of used batteries according to the manufacturer's instructions.

**WARNING!** Some internal parts of the system may have high electrical voltage. And therefore we strongly recommend that qualified engineers can open and disassemble the system. The LCD and Touchscreen are easily breakable, please handle them with extra care.