

# **USER'S MANUAL**

**PA-6622**

**10.4" POS Terminal**

**Powered by Intel® Celeron®**

**J1900 Quad-Core**

**PA-6622 M6**

---

---

# *PA-6622 POS System*

## **COPYRIGHT NOTICE & TRADEMARK**

All trademarks and registered trademarks mentioned herein are the property of their respective owners.

This manual is copyrighted Jan. 2014. You may not reproduce or transmit in any form or by any means, electronic, or mechanical, including photocopying and recording.

## **DISCLAIMER**

This user's manual is meant to assist users in installing and setting up the system. The information contained in this document is subject to change without any notice.

## **CE NOTICE**

This is a class A product. In a domestic environment this product may cause radio interference in which case the user may be required to take adequate measures.

---

---

## FCC NOTICE

This equipment has been tested and found to comply with the limits for a Class A digital device, pursuant to part 15 of the FCC Rules. These limits are designed to provide reasonable protection against harmful interference when the equipment is operated in a commercial environment. This equipment generates, uses, and can radiate radio frequency energy and, if not installed and used in accordance with the instruction manual, may cause harmful interference to radio communications. Operation of this equipment in a residential area is likely to cause harmful interference in which case the user will be required to correct the interference at his own expense.

You are cautioned that any change or modifications to the equipment not expressly approve by the party responsible for compliance could void your authority to operate such equipment.

**CAUTION!** Danger of explosion if battery is incorrectly replaced. Replace only with the same or equivalent type recommended by the manufacturer. Dispose of used batteries according to the manufacturer's instructions.

**WARNING!** Some internal parts of the system may have high electrical voltage. And therefore we strongly recommend that qualified engineers can open and disassemble the system. The LCD and Touchscreen are easily breakable, please handle them with extra care.

# ***INTRODUCTION***

CHAPTER

***1***

This chapter gives you the information for the PA-6822. It also outlines the system specifications.

Sections included:

- About This Manual
- POS System Illustration
- System Specifications
- Safety precautions

**Experienced users can jump to chapter 2 on page 2-1 for a quick start.**

## **1-1. ABOUT THIS MANUAL**

Thank you for purchasing our PA-6622 Series System. The PA-6622 is an updated system designed to be comparable with the highest performance of IBM AT personal computers. The PA-6622 provides faster processing speed, greater expandability and can handle more tasks than before. This manual is designed to assist you how to install and set up the whole system. It contains four chapters and two appendixes. Users can configure the system according to their own needs.

### ***Chapter 1 Introduction***

This chapter introduces you to the background of this manual. It also includes illustrations and specifications for the whole system. The final section of this chapter indicates some safety reminders on how to take care of your system.

### ***Chapter 2 System Configuration***

This chapter outlines the location of motherboard, printer, VFD, MSR components and their function. You will learn how to set the jumpers and configure the system to meet your own needs.

### ***Chapter 3 Software***

This chapter contains detailed information for driver installations of the Intel<sup>®</sup> Utility, VG, LAN, Sound, Touch Screen, embedded peripheral devices, BIOS setup & update, Watchdog timer and resource map.

### ***Chapter 4 System Diagrams***

This chapter shows the exploded diagrams and part numbers of PA-6622 components.

## 1-2. POS SYSTEM ILLUSTRATION

Top View

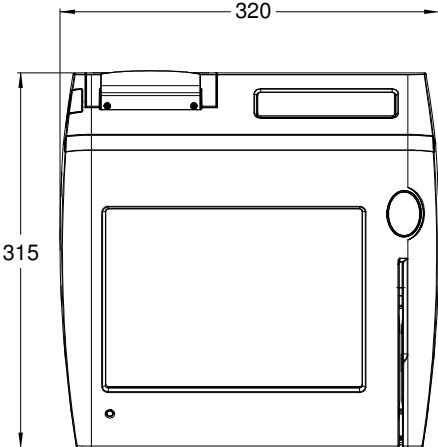

Bottom View

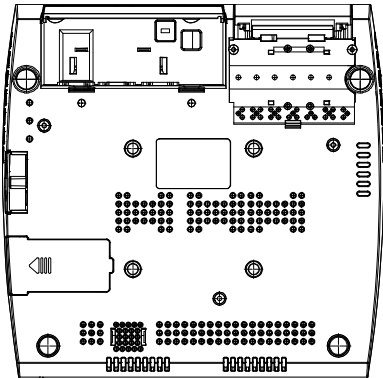

Front View

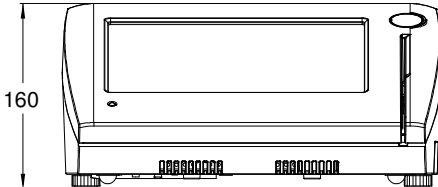

Side View

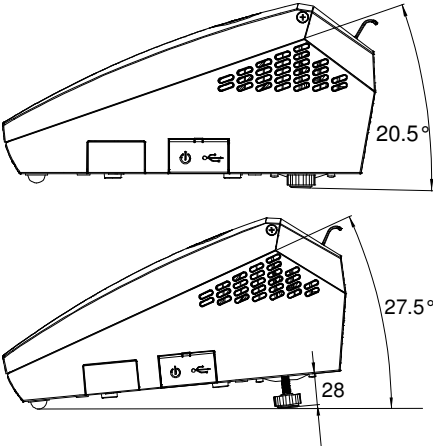

Unit: mm

Quarter View

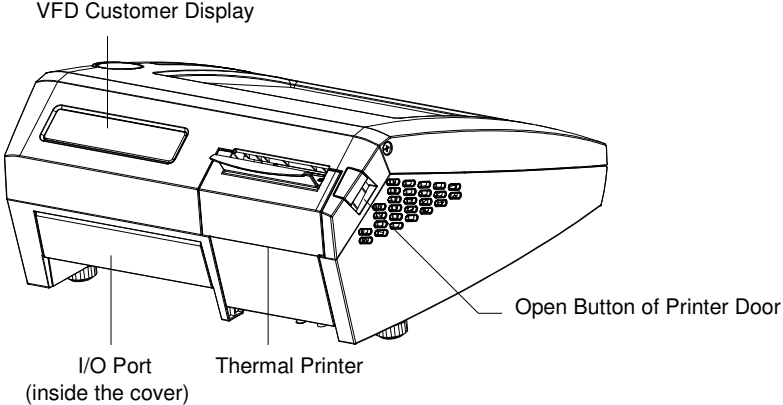
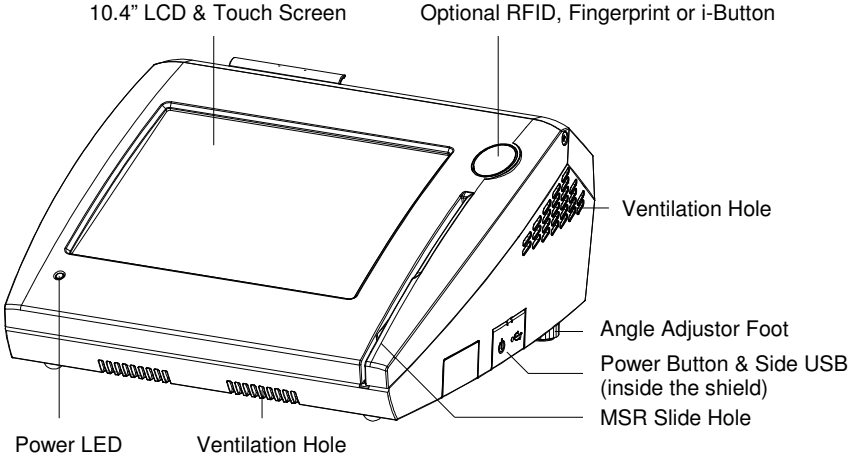

Unit: mm

### 1-3. SYSTEM SPECIFICATIONS

#### System

CPU	Intel® Celeron® J1900 Quad-Core 2.0GHz															
Memory	1 x DDR3 SO-DIMM 204-pin socket, up to 8GB															
OS Support	<ul style="list-style-type: none"> <li>Windows Embedded 8 Industry Pro Retail</li> <li>Window Embedded POSReady7</li> </ul>															
LAN	1 x Giga LAN															
Wireless LAN (Optional)	<p>802.11 b/g/n</p> <table border="1"> <thead> <tr> <th>AP distance</th> <th>0°</th> <th>90°</th> <th>180°</th> <th>270°</th> </tr> </thead> <tbody> <tr> <td>5M</td> <td>-32 dB</td> <td>-27 dB</td> <td>-37 dB</td> <td>-33 dB</td> </tr> <tr> <td>10M</td> <td>-43 dB</td> <td>-37 dB</td> <td>-46 dB</td> <td>-44 dB</td> </tr> </tbody> </table> <p><b>Note:</b></p> <ol style="list-style-type: none"> <li>Test tolerance: <math>\pm 5</math>dB</li> <li>AP: ASUS RT-N56U (2 x internal antenna with 3.8 dBi gain)</li> </ol>	AP distance	0°	90°	180°	270°	5M	-32 dB	-27 dB	-37 dB	-33 dB	10M	-43 dB	-37 dB	-46 dB	-44 dB
AP distance	0°	90°	180°	270°												
5M	-32 dB	-27 dB	-37 dB	-33 dB												
10M	-43 dB	-37 dB	-46 dB	-44 dB												
Audio	2W speaker & Line-out Port															
BIOS	AMI SPI BIOS, 8 Mbits with VGA BIOS															
System Weight	With power adapter approx. 6 kg															
Dimension (W x H x D)	320mm x 160mm x 315mm															
Viewing Angel	24~30°															



Power Consumption (AC):

System Status	CPU/HDD/Memory	VFD	Printer	COM & USB Ports to supply power of Rear I/O	Consumption
OFF	Off				2W
IDLE	Turns on, but not to execute extra AP	Runs new ticker	Standby	without	19.8W
Working (without printer)	100% loading of burn-in test				
Working (with printer)			DC24V 1.4A dummy load		59.1W
Full Loading					USB dummy load 500mA x4

Certificate: CE, CE-LVD, FCC

Type	Standard	Description
EMI	EN 55022 Class A	-
EMS	EN 55024	-
IEC 61000-4-2	ESD	<ul style="list-style-type: none"> <li>▪ 8kV air discharge</li> <li>▪ 4kV contact discharge</li> </ul>
IEC 61000-4-3	RS	80~1000MHz, 3V/m, 80% AM(1kHz)
IEC 61000-4-4	EFT	<ul style="list-style-type: none"> <li>▪ AC Power Port: 1kV</li> <li>▪ DC Power Port: 0.5kV</li> <li>▪ Signal Ports &amp; Telecommunication Ports: 0.5kV</li> </ul>
IEC 61000-4-5	Surge	<ul style="list-style-type: none"> <li>▪ AC Power Port: Line to line: 1kV Line to earth(GND): 2kV</li> <li>▪ DC Power Port: Line to earth(GND): 0.5kV</li> <li>▪ Signal and Telecommunication Port: Line to GND: 1kV</li> </ul>
IEC 61000-4-6	CS	0.15~80MHz, 3Vrms, 80% AM, 1kHz
IEC 61000-4-8	PFMF	50Hz, 1A/m
IEC 61000-4-11	Voltage Dips	<ul style="list-style-type: none"> <li>▪ &gt; 95% reduction for 0.5 periods</li> <li>▪ 30% reduction for 25 periods</li> </ul>
	Voltage Interruptions	> 95% reduction for 250 periods

**Display**

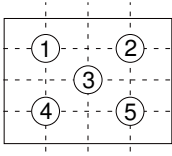
10.4" TFT LCD	Resolution: 1024 x 768 & 800 x 600 Signal Interface: TTL (18-bit)																		
Touchscreen	10.4" 5-wire Resistive type																		
Brightness	<ul style="list-style-type: none"> <li>▪ Resolution: 1024 x 768 (LED backlight) <table border="1" style="margin-left: 20px;"> <thead> <tr> <th>Minimum</th> <th>Typical</th> <th>Maximum</th> </tr> </thead> <tbody> <tr> <td>240 cd/m<sup>2</sup></td> <td>340 cd/m<sup>2</sup></td> <td>-</td> </tr> </tbody> </table> </li>   <li>▪ Resolution: 800 x 600 (CCFL backlight) <table border="1" style="margin-left: 20px;"> <thead> <tr> <th>Minimum</th> <th>Typical</th> <th>Maximum</th> </tr> </thead> <tbody> <tr> <td>138 cd/m<sup>2</sup></td> <td>195 cd/m<sup>2</sup></td> <td>-</td> </tr> </tbody> </table> </li>   <li>▪ Resolution: 800 x 600 (LED backlight) <table border="1" style="margin-left: 20px;"> <thead> <tr> <th>Minimum</th> <th>Typical</th> <th>Maximum</th> </tr> </thead> <tbody> <tr> <td>240 cd/m<sup>2</sup></td> <td>340 cd/m<sup>2</sup></td> <td>-</td> </tr> </tbody> </table> </li> </ul> <div style="text-align: right; margin-top: 10px;">  </div>	Minimum	Typical	Maximum	240 cd/m <sup>2</sup>	340 cd/m <sup>2</sup>	-	Minimum	Typical	Maximum	138 cd/m <sup>2</sup>	195 cd/m <sup>2</sup>	-	Minimum	Typical	Maximum	240 cd/m <sup>2</sup>	340 cd/m <sup>2</sup>	-
Minimum	Typical	Maximum																	
240 cd/m <sup>2</sup>	340 cd/m <sup>2</sup>	-																	
Minimum	Typical	Maximum																	
138 cd/m <sup>2</sup>	195 cd/m <sup>2</sup>	-																	
Minimum	Typical	Maximum																	
240 cd/m <sup>2</sup>	340 cd/m <sup>2</sup>	-																	

**Environment**

Temperature	<ul style="list-style-type: none"> <li>▪ Operating: 0~35°C (32 ~ 95°F)</li> <li>▪ Storage: -5~60°C (-4 ~ 140°F)</li> </ul>
Humidity	20~90%

**Optional accessories**

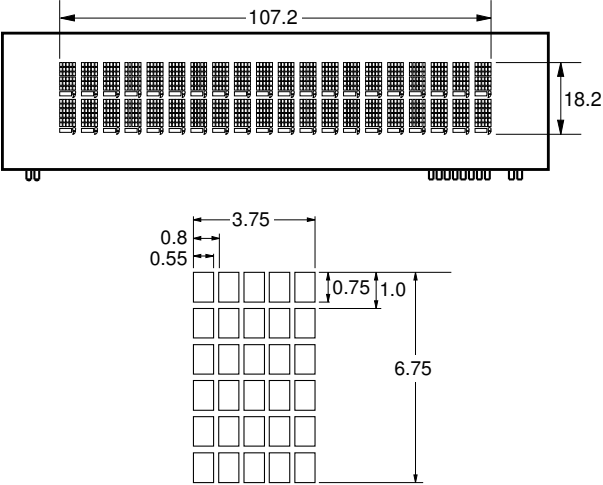
MSR & i-Button	ISO I ,II, III; JIS I,II and support information key reader
RFID	ISO14443A, Mifare, Felica-lite
Fingerprint	8-bit grayscale reader
Customer Display	<ul style="list-style-type: none"> <li>▪ Interface: RS-232C Baud Rate: 9600/19200 bps</li> <li>▪ Placement: 20 columns and 2 lines, each column is 5 x 7 dots</li> <li>▪ Brightness: cd/m<sup>2</sup></li> <li>▪ Dimensions:</li> </ul>  <ul style="list-style-type: none"> <li>▪ Standard Code CP-437, CP-850, CP-857, CP-865, Katakana</li> <li>▪ International Characters USA, FRANCE, GERMANY, UK, DENMARK I, SWDEN, ITALY, SPAIN, JAPAN, NORWAY, DENMARK II, RUSSIA, SLAVONIC</li> </ul>

Items	Specifications
Printing method	Thermal dot line printing
Printing accuracy	1 mm /5M
Paper feed pitch	0.0625 mm
Maximum Paper-Roll thickness	80mm
Total dots per line & Printable dots per line	2inch 432 dots; 3inch 576 dots
Maximum print speed	2inch 200 mm/s; 3inch 170 mm/s
Print width	2inch 54 mm; 3inch 72mm
Paper width	2inch 58 +0/-1 mm; 3inch 80 +0/-1 mm

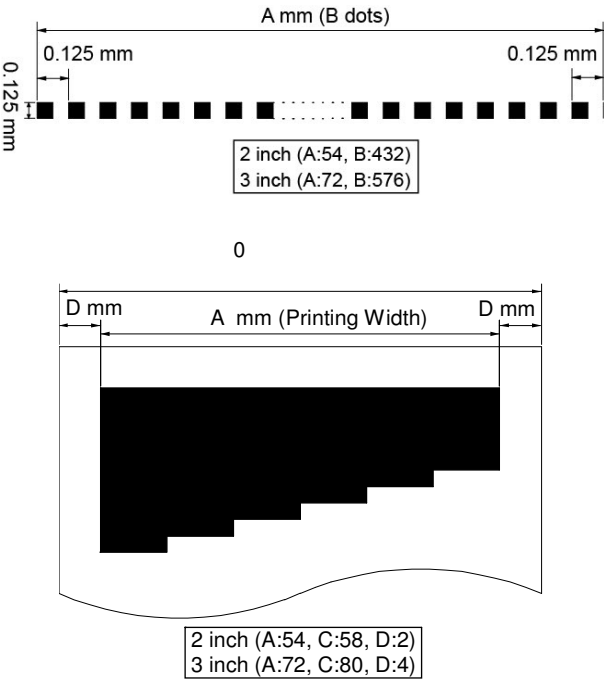

Printer	Auto-cutter:																
	<table border="1"> <thead> <tr> <th>Items</th> <th>Specifications</th> </tr> </thead> <tbody> <tr> <td>Paper cutting method</td> <td>Slide cutting</td> </tr> <tr> <td>Type of paper cutting</td> <td>Full cut and Partial cut (1.5 ±0.5 mm tab left at the center)</td> </tr> <tr> <td>Paper curling tendency</td> <td>Fixed blade side and Movable blade side</td> </tr> <tr> <td>Minimum paper core diameter</td> <td>φ8 mm (paper thickness: 75μm or thin) φ18 (paper thickness: thicker than 75μm)</td> </tr> <tr> <td>Minimum paper cutting length</td> <td>10 mm</td> </tr> <tr> <td>Cutting processing time</td> <td>Approx. 0.5 s/cycle</td> </tr> <tr> <td>Cutting frequency</td> <td>1 cut/2 s max.</td> </tr> </tbody> </table>	Items	Specifications	Paper cutting method	Slide cutting	Type of paper cutting	Full cut and Partial cut (1.5 ±0.5 mm tab left at the center)	Paper curling tendency	Fixed blade side and Movable blade side	Minimum paper core diameter	φ8 mm (paper thickness: 75μm or thin) φ18 (paper thickness: thicker than 75μm)	Minimum paper cutting length	10 mm	Cutting processing time	Approx. 0.5 s/cycle	Cutting frequency	1 cut/2 s max.
	Items	Specifications															
	Paper cutting method	Slide cutting															
	Type of paper cutting	Full cut and Partial cut (1.5 ±0.5 mm tab left at the center)															
	Paper curling tendency	Fixed blade side and Movable blade side															
	Minimum paper core diameter	φ8 mm (paper thickness: 75μm or thin) φ18 (paper thickness: thicker than 75μm)															
	Minimum paper cutting length	10 mm															
	Cutting processing time	Approx. 0.5 s/cycle															
	Cutting frequency	1 cut/2 s max.															
<ul style="list-style-type: none"> <li>▪ Standard Code CP-437, CP-850, CP-857, CP-737, CP-852, CP-860, CP-862, CP-863, CP-865, CP-866, CP-1250, CP-1251, CP-1252, CP-1253, CP-1254, CP-1257, Katakana</li> <li>▪ KANJI JAPANESE (SHIFT-JIS) Code, TRADITIONAL CHINESE Code</li> <li>▪ International Characters USA, FRANCE, GERMANY, UK, DENMARK I, SWDEN, ITALY, SPAIN I, JAPAN, NORWAY, DENMARK II, SPAIN II, LATIN AMERICA, KOREA, RUSSIA, SLAVONIC</li> </ul>																	

## 1-4. SAFETY PRECAUTIONS

### 1-4-1. Wall-Mount Cautions

1. Leave 0.5 cm of space between wall and the bottom of PA-6622.

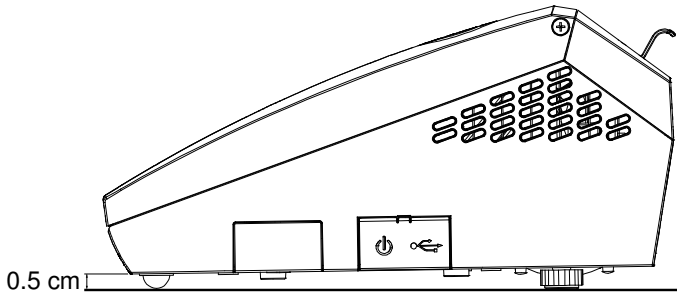

2. Do not embed PA-6622 in concrete.

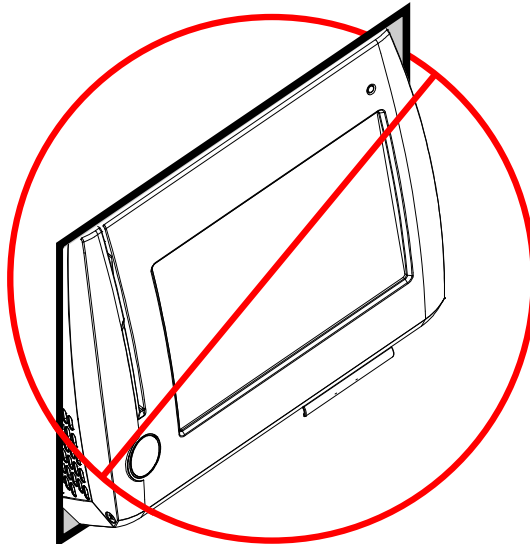

## **1-4-2. Safety Precautions**

The following messages are safety reminders on how to protect your systems from damages, and extending the life cycle of the system.

1. Check the Line Voltage
  - a. The operating voltage for the power supply should be within the range of 100V to 240V AC; otherwise the system may be damaged.
  
2. Environmental Conditions
  - a. Place your PA-6622 on a sturdy, level surface. Be sure to allow enough space around the system to have easy access needs.
  - b. Avoid installing your PA-6622 Series POS system in extremely hot or cold places.
  - c. Avoid exposure to sunlight for a long period of time (for example, in a closed car in summer time. Also avoid the system from any heating device.). Or do not use the PA-6622 when it has been left outdoors in a cold winter day.
  - d. Bear in mind that the operating ambient temperature is between 0°C and 35°C (32°F and 95°F).
  - e. Avoid moving the system rapidly from a hot place to a cold place, and vice versa, because condensation may occur inside the system.
  - f. Protect your PA-6622 against strong vibrations, which may cause hard disk failure.
  - g. Do not place the system too close to any radio-active device. Radio-active device may cause signal interference.
  - h. Always shutdown the operation system before turning off the power.
  
3. Handling
  - a. Avoid placing heavy objects on the top of the system.
  - b. Do not turn the system upside down. This may cause the hard drive to malfunction.
  - c. Do not allow any objects to fall into this product.
  - d. If water or other liquid spills into the product, unplug the power cord immediately.

---

---

## FCC NOTICE

This equipment has been tested and found to comply with the limits for a Class A digital device, pursuant to part 15 of the FCC Rules. These limits are designed to provide reasonable protection against harmful interference when the equipment is operated in a commercial environment. This equipment generates, uses, and can radiate radio frequency energy and, if not installed and used in accordance with the instruction manual, may cause harmful interference to radio communications. Operation of this equipment in a residential area is likely to cause harmful interference in which case the user will be required to correct the interference at his own expense.

You are cautioned that any change or modifications to the equipment not expressly approve by the party responsible for compliance could void your authority to operate such equipment.

**CAUTION!** Danger of explosion if battery is incorrectly replaced. Replace only with the same or equivalent type recommended by the manufacturer. Dispose of used batteries according to the manufacturer's instructions.

**WARNING!** Some internal parts of the system may have high electrical voltage. And therefore we strongly recommend that qualified engineers can open and disassemble the system. The LCD and Touchscreen are easily breakable, please handle them with extra care.



# ***SYSTEM CONFIGURATION***

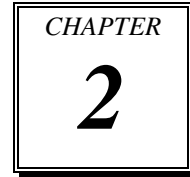

Helpful information that describes the jumper and connector settings, component locations, and pin assignment.

Sections included:

- System External I/O Port Pin Assignment
- How to Set Jumpers
- Component Locations & Jumper Settings
  - Mainboard
  - Printer Board (peripheral device)
  - VFD Board (peripheral device)
  - MSR Board (peripheral device)

## 2-1. SYSTEM EXTERNAL I/O PORT & PIN ASSIGNMENT

### Rear I/O

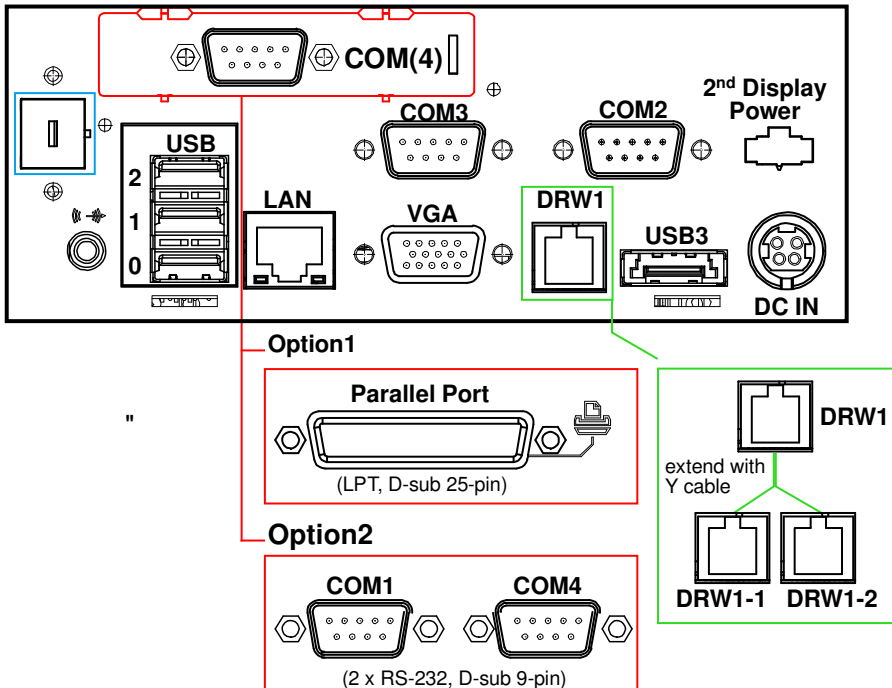

### Side I/O

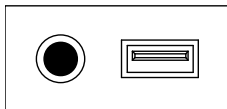

Power button    USB4

**Power Button**

To turn on the system, press the power button on the side of the system briefly.

ACTION	ASSIGNMENT
Click	0V
Release	+3.3V



**Power Button**

**DC-IN Port**

**DC IN:** DC Power-In Port (rear IO)

PIN	ASSIGNMENT	PIN	ASSIGNMENT
1	GND	3	+24V
2	GND	4	+24V

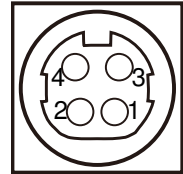

**DC IN**

**VGA Port**

**VGA:** VGA Port, D-Sub 15-pin (rear IO)

PIN	ASSIGNMENT	PIN	ASSIGNMENT
1	RED	9	+5V
2	GREEN	10	GND
3	BLUE	11	NC
4	NC	12	DDCA DATA
5	GND	13	HSYNC
6	GND	14	VSYNC
7	GND	15	DDCA CLK
8	GND		

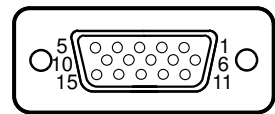

**VGA**

## COM Port

### COM2, COM3, COM4: D-Sub9 Serial Ports (rear IO)

- COM2: Co-lay with COM2-1
- COM3: Co-lay with COM3-1

PIN	ASSIGNMENT	PIN	ASSIGNMENT
1	DCD	6	DSR
2	RXD	7	RTS
3	TXD	8	CTS
4	DTR	9	RI/+5V/+12V selectable (Max. current: 1A)
5	GND		

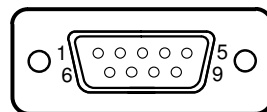

**COM2/  
COM3/  
COM4**

**Note:** COM3 & COM3-1 will not function when jumpers JP20, JP21, JP22 are set as 2-3 connected (i-Button). Refer to the section *i-Button Function Selection* for details. COM4-2 will not function when COM4-1 is selected as the printer control interface.

## LAN Port

### LAN: LAN RJ45 Port (rear IO)

PIN	ASSIGNMENT	PIN	ASSIGNMENT
1	MDIP0	5	MDIP2
2	MDIN0	6	MDIN2
3	MDIP1	7	MDIP3
4	MDIN1	8	MDIN3

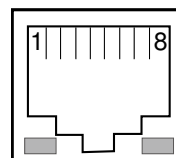

Green Yellow  
**LAN**

### LAN LED Indicator:

#### Right Side LED

Yellow Color Blinking	LAN Message Active
Off	No LAN Message Active

#### Left Side LED

Green Color On	10/100Mbps LAN Speed Indicator
Orange Color on	Giga LAN Speed Indicator
Off	No LAN switch/ hub connected.

**Cash Drawer Port**

DRW1 is used by default. If you need a second port, adopt the method below.

PIN	ASSIGNMENT	PIN	ASSIGNMENT
1	GND	4	+12V/+24V (Max. current: 1A)
2	Drawer Open	5	NC
3	Drawer Sense	6	GND

DRW1	
<b>Open</b>	Write "700" to I/O port "588"
<b>Close</b>	Write "00" to I/O port "588"

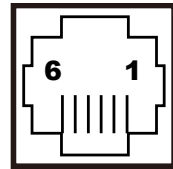

**DRW1**  
**DRW2**

**DRW2 Only support PA-6822 selected "Printer kit"**

Signal from printer board (MB-1030, MB-1011(3), PDAC3100) and be controlled by command. DRW2 port on the bottom of Stand with a cable (optional).

Control Codes	Hexadecimal Codes	Function
<DLE EOT>	10 04	Real-time status transmission
<DLE DC4>	10 14	Real-time output of specified pulse

**USB Port**

**USB0, USB1, USB2, USB3, USB4:** USB Type A Ports

- USB0~3: Rear I/O
- USB4: Side IO

PIN	ASSIGNMENT	PIN	ASSIGNMENT
1	+5V (Max. current: 0.5A)	3	D+
2	D-	4	GND



**USB0/  
USB1/  
USB2/  
USB4**

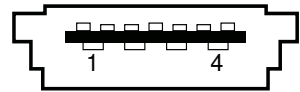

**USB3**

**Printer Port (Optional)**

**LPT:** Printer Port, D-Sub 25-pin, co-lay with LPT1

PIN	ASSIGNMENT	PIN	ASSIGNMENT
1	STBJ	14	ALFJ
2	PDR0	15	ERRJ
3	PDR1	16	PARR_INITJ
4	PDR2	17	SLCTINJ
5	PDR3	18	GND
6	PDR4	19	GND
7	PDR5	20	GND
8	PDR6	21	GND
9	PDR7	22	GND
10	ACKJ	23	GND
11	BUSY	24	GND
12	PE	25	GND
13	SLCTJ		

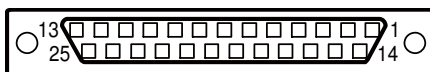

**LPT**

## 2-2. MAINBOARD COMPONENT LOCATIONS & JUMPER SETTINGS

M/B: PB-6822

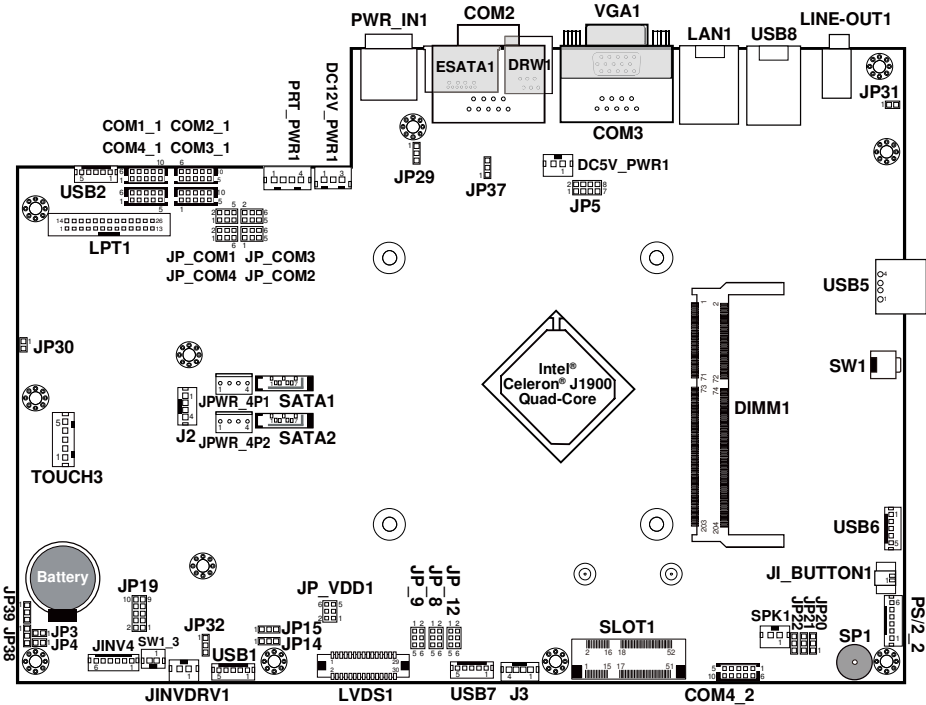

PB-6822 Mainboard Component Locations

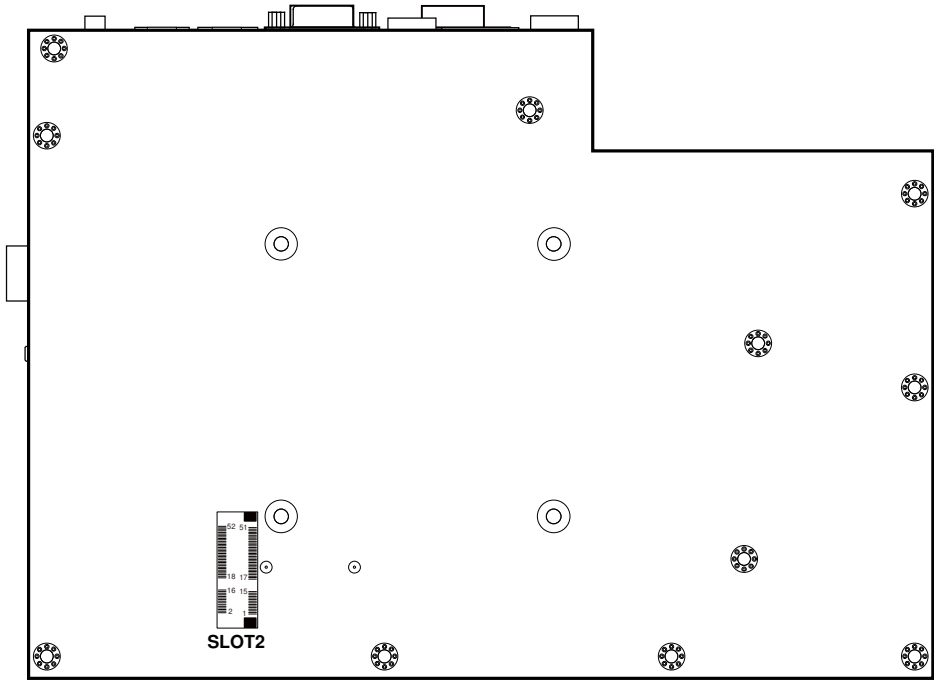

**PB-6822 Mainboard Component Locations - Rear**



## How to Set Jumpers

You can configure your board by setting the jumpers. A jumper consists of two or three metal pins with a plastic base mounted on the card, and by using a small plastic "cap", also known as the jumper cap (with a metal contact inside), you are able to connect the pins. So you can set-up your hardware configuration by "opening" or "closing" pins.

Jumpers can be combined into sets that called jumper blocks. When jumpers are all in the block, you have to put them together to set up the hardware configuration. The figure below shows what this looks like.

### Jumpers & caps

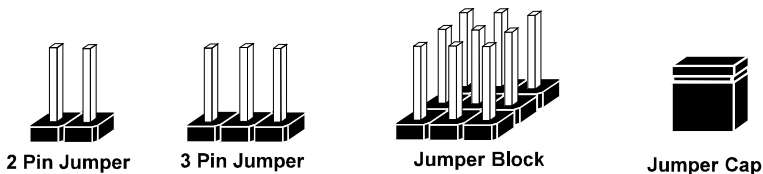

If a jumper has three pins for example, labelled PIN1, PIN2, and PIN3. You can connect PIN1 & PIN2 to create one setting and shorting. You can either connect PIN2 & PIN3 to create another setting. The same jumper diagrams are applied all through this manual. The figure below shows what the manual diagrams look and what they represent.

**Jumper diagrams**



Jumper Cap looks like this

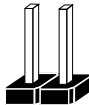

2 pin Jumper looks like this

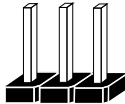

3 pin Jumper looks like this

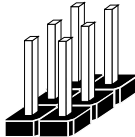

Jumper Block looks like this

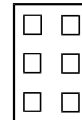

**Jumper settings**



2 pin Jumper closed(enabled)  
looks like this



1

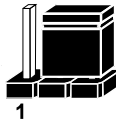

3 pin Jumper  
2-3 pin closed(enabled)  
looks like this

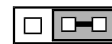

1





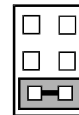



Jumper Block  
1-2 pin closed(enabled)  
looks like this

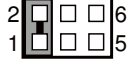

1 2

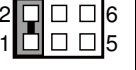
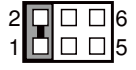
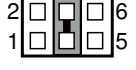

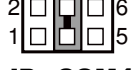
**COM Port RI & Voltage Selection**

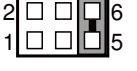
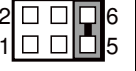
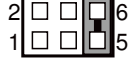
JP\_COM1, JP\_COM2, JP\_COM3, JP\_COM4: Pin-headers on board

SELECTION	JUMPER SETTING	JUMPER ILLUSTRATION			
RI	1-2	 <b>JP_COM1</b>	 <b>JP_COM2</b>	 <b>JP_COM3</b>	 <b>JP_COM4</b>
+12V	3-4	 <b>JP_COM1</b>	 <b>JP_COM2</b>	 <b>JP_COM3</b>	 <b>JP_COM4</b>
+5V	5-6	 <b>JP_COM1</b>	 <b>JP_COM2</b>	 <b>JP_COM3</b>	 <b>JP_COM4</b>

**Cash Drawer Power Selection**

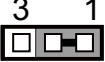
JP29: DRW1.'FTY '3/3.'FTY '3/4

SELECTION	JUMPER SETTING	JUMPER ILLUSTRATION
+24V	1-2	 JP29
+12V	2-3	 JP29

**COM2 / COM3 / DRW1**

1. Voltage of external ports "COM2 & COM3 & Cash Drawer" are made to control on BIOS for your convenience. The corresponding jumpers "JP\_COM2~3", "JP29" are set open (no jumper connection) by default.
2. "JP\_COM2", "JP\_COM3", "JP29" are enabled when voltage adjustment is disabled on BIOS
3. Voltage control is adjustable by BIOS or jumpers. Either way cannot be applied simultaneously in case of system error, component damage or serious boot failure.

Advanced		
COM2 select	[12V]	Cash drawer select 12V 24V
COM3 select	[RI]	
Cash drawer	[Cash drawer 24V]	

Advanced		
COM2 select	[Disabled]	COM3 select RI 12V and 5V
COM3 select	[Disabled]	
Cash drawer	[Cash drawer 12V]	

**COM1 / COM4**

Voltage of COM1 & COM4 ports are made to control by jumpers on board.

## DRW1 Extension

**JP37:** DRW1-2 control connector

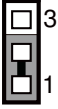
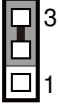
SELECTION	JUMPER SETTING	JUMPER ILLUSTRATION
FTY "3/3 - 'FTY "3/4	1-2	 <b>JP37</b>
FTY "3/3	2-3	 <b>JP37</b>

### Step.1

DRW1 includes two groups of GPIO pins. The second group is normally unused but can be enabled by the jumper.

Set the pin-header jumper JP37 as 1-2 connected if necessary.

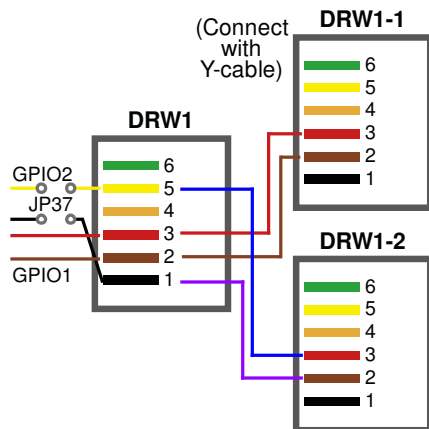

### Step.2

You can split DRW1 into two channels of DRW1-1 & DRW1-2 with the Y-Cable(optional unit).

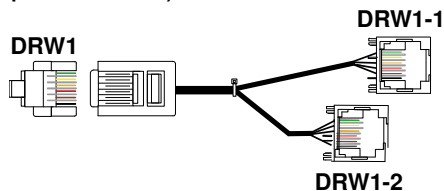

**DRW1, DRW1-1, DRW1-2:** Signal from M/B GPIO (rear I/O)

Step.3

DRW1, DRW1-1, DRW1-2 shares the same power source (refer to Cash Drawer Power Selection for adjustment, default at 12V).

Á

PIN	ASSIGNMENT	PIN	ASSIGNMENT
1	GND	4	+12V/+24V (Max. current: 1A)
2	Drawer Open	5	NC
3	Drawer Sense	6	GND

DRW1-1	OPEN		CLOSE	
PB-6822RA, RB	Write	To	Write	To
		700h	588h	000h
PB-6822RC	Write	To	Write	To
		02h	SIO LDN 06h's 90h	00h

DRW1-2	OPEN		CLOSE	
PB-6822RA, RB	Write	To	Write	To
		N/A	N/A	N/A
PB-6822RC	Write	To	Write	To
		04h	SIO LDN 06h's 90h	00h

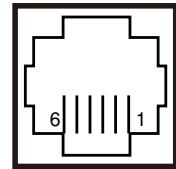

**DRW1/  
DRW1-1/  
DRW1-2**

## COM Connector

### COM1-1, COM2-1, COM3-1, COM4-1, COM4-2: COM Connectors

PIN	ASSIGNMENT	PIN	ASSIGNMENT
1	DCD	6	DSR
2	RXD	7	RTS
3	TXD	8	CTS
4	DTR	9	RI/+5V/+12V selectable (Max. current: 1A)
5	GND	10	NC



**COM1-1/  
COM2-1/  
COM3-1/  
COM4-1**

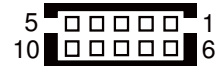

**COM4-2**

**Note:** Each COM connector is selectable for RI/+5V/+12V.  
For details, refer to *COM Port RI & Voltage Selection*.

## I-Button Connector

### J1\_BUTTON1: i-Button Connector

PIN	ASSIGNMENT
1	COM3_DTR_R_I
2	COM3_RXD_R_I

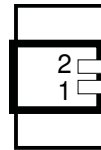

**J1\_BUTTON1**

## I-Button Function Selection

### JP20, JP21, JP22: i-Button Function Connectors

SELECTION	JUMPER SETTING	JUMPER ILLUSTRATION
COM 3	1-2	<p><b>JP20/JP21/JP22</b></p>
i-Button*	2-3	<p><b>JP20/JP21/JP22</b></p>

**Note:** Manufacturing Default is COM3.

\*COM3 & COM3-1 will not function when jumpers JP20, JP21 & JP22 are set as “i-Button.”

## USB Connector

**USB1, USB2, USB6, USB7:** USB connector

PIN	ASSIGNMENT
1	5V (Maximum current: 0.5A)
2	D-
3	D+
4	GND
5	GND

**Note:** USB1 would be used when jumpers JP14 & JP15 are set as 1-2 (short) connected.

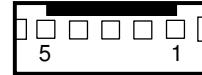

**USB1/  
USB2/  
USB7  
USB6**

## LED Connector

**LED1-1:** Power indication LED connector

PIN	ASSIGNMENT
1	GND
2	PWR_LED

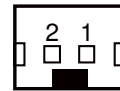

**LED1-1**

## Inverter Connector

**JINV4:** Inverter connectors

PIN	ASSIGNMENT
1	+12V
2	+12V
3	GND
4	BRCTR
5	GND
6	LVDS_BKLTEN



**JINV4**



**Power Connector**

**DC12V\_PWR1:** DC 12Voltage Provider Connector

PIN	ASSIGNMENT
1	VCC12
2	GND
3	VCC12

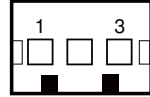

**DC12V\_PWR1**

**DC5V\_PWR1:** DC 5Voltage Provider Connector

PIN	ASSIGNMENT
1	5V
2	GND

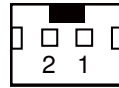

**DC5V\_PWR1**

**Power for Thermal Printer Connector**

**PRT\_PWR1:** Power for Thermal Printer Connector

PIN	ASSIGNMENT
1	VCC24SB
2	VCC24SB
3	GND
4	GND

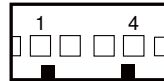

**PRT\_PWR1**

**External Speaker Connector**

**SPK1:** External speaker connector

PIN	ASSIGNMENT
1	SPK_GND
2	SPK_OUT

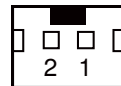



**SPK1**

### LED Backlight Power Control Selection

**JP12:** LED backlight power control connectors

(for LED backlight panel without power driver built-in)

SELECTION	JUMPER SETTING	JUMPER ILLUSTRATION
Control by driver on M/B	1-3, 2-4 It applied to the panel without driver built-in.	 <p><b>JP12</b></p>
Control by PWM	3-5, 4-6 It applied to the panel built-in driver inside.	 <p><b>JP12</b></p>

**Note:** Manufacturing Default is LED.

### LED Backlight Power Connector

**JINVDRV1:** LED backlight power connector

PIN	ASSIGNMENT
1	VCC
2	GND

**Note:** JINVDRV1 will not function when JP38 & JP39 are set as “RS-232” interface.

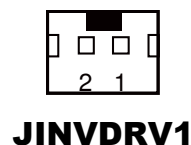

**Panel Resolution Selection**

**JP8, JP9:** Panel resolution control connectors

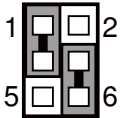
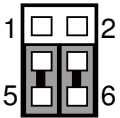
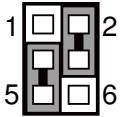
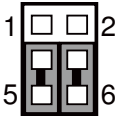
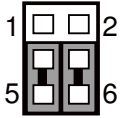
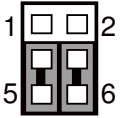
SELECTION	JUMPER SETTING	JUMPER ILLUSTRATION	
15" 1024 x 768 (24 bit)	JP8: 1-3, 4-6 JP9: 3-5, 4-6	 <p><b>JP8</b></p>	 <p><b>JP9</b></p>
10.4" 1024 x 768 (18 bit)	JP8: 3-5, 2-4 JP9: 3-5, 4-6	 <p><b>JP8</b></p>	 <p><b>JP9</b></p>
10.4" 800 x 600 (18bit)	JP8: 3-5, 4-6 JP9: 3-5, 4-6	 <p><b>JP8</b></p>	 <p><b>JP9</b></p>

**Note:** Manufacturing Default is 15", 1024 x 768





**LVDS Connector****LVDS1:** LVDS Connector

PIN	ASSIGNMENT	PIN	ASSIGNMENT
1	LVDS_VCC	16	LVDS_CLKA_D+
2	GND	17	VDS_CLKA_D-
3	NC	18	GND
4	NC	19	LVDS_A2_D+
5	GND	20	LVDS_A2_D-
6	LVDS_B2_D-	21	GND
7	LVDS_B2_D+	22	LVDS_A1_D+
8	GND	23	LVDS_A1_D-
9	LVDS_B1_D-	24	GND
10	LVDS_B1_D+	25	LVDS_A0_D+
11	LVDS_B3_D+	26	LVDS_A0_D-
12	LVDS_B3_D-	27	LVDS_A3_D+
13	LVDS_B0_D+	28	LVDS_A3_D-
14	LVDS_B0_D-	29	LVDS_VCC
15	GND	30	LVDS_VCC

**LVDS1**

**Touch Panel Signal Interface Selection**

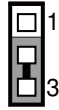
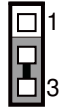
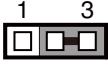
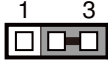
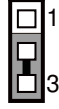
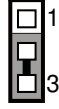
**JP14, JP15, JP38, JP39:** Control connectors for touch panel signal interface

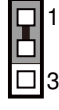
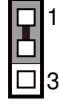
SELECTION	JUMPER SETTING	JUMPER ILLUSTRATION			
USB1 Connector	JP14: 1-2 JP15: 1-2 JP38: 2-3 JP39: 2-3	 <b>JP14</b>	 <b>JP15</b>	 <b>JP38</b>	 <b>JP39</b>
USB Interface	JP14: 2-3 JP15: 2-3 JP38: 2-3 JP39: 2-3	 <b>JP14</b>	 <b>JP15</b>	 <b>JP38</b>	 <b>JP39</b>
RS-232 Interface	JP14: 1-2 JP15: 1-2 JP38: 1-2 JP39: 1-2	 <b>JP14</b>	 <b>JP15</b>	 <b>JP38</b>	 <b>JP39</b>

**Note:** 1. Manufacturing Default is USB.

2. The COM2 & COM2-1 connector will not function when JP38 & JP39 are set as 1-2 connected.
3. USB1 connector when JP14 & JP15 are set as 1-2 connected.

**Touch Panel Connector**

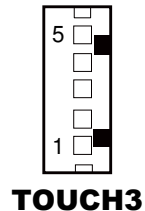

**TOUCH3:** Touch panel connectors

PIN	ASSIGNMENT	PIN	ASSIGNMENT
1	LR (Low Right)	4	UR (Up Right)
2	LL (Low Left)	5	UL (Up Left)
3	Probe		



### Clear CMOS Data Selection

**JP3:** Clear CMOS data selection

SELECTION	JUMPER SETTING	JUMPER ILLUSTRATION
Normal	Open	 <b>JP3</b>
Clear CMOS*	1-2	 <b>JP3</b>

**Note:** Manufacturing Default is Normal.

\*To clear CMOS data, you must power-off the computer and set the jumper to “Clear CMOS” as illustrated above. After five to six seconds, set the jumper back to “Normal” and power-on the computer.

### Printer Connector



**LPT1**

**LPT1:** Printer connector

PIN	ASSIGNMENT	PIN	ASSIGNMENT
1	STBJ	14	ALFJ
2	PDR0	15	ERRJ
3	PDR1	16	PAR_INITJ
4	PDR2	17	SLCTINJ
5	PDR3	18	GND
6	PDR4	19	GND
7	PDR5	20	GND
8	PDR6	21	GND
9	PDR7	22	GND
10	ACKJ	23	GND
11	BUSY	24	GND
12	PE	25	GND
13	SLCTJ	26	NC

## SATA & SATA Power Connector

SATA1, SATA2: Serial ATA connectors

PIN	ASSIGNMENT	PIN	ASSIGNMENT
1	G1	5	RX-
2	TX+	6	RX+
3	TX-	7	G3
4	G2		

**Note:** SATA1 only supports the optional RAID function on board.



**SATA1/  
SATA2**

JPWR\_4P1, JPWR\_4P2: Serial ATA power connectors

PIN	ASSIGNMENT
1	VCC
2	GND
3	GND
4	VCC12

**Note:** JPWR\_4P1 only supports the optional RAID function on board.



**JPWR\_4P1/  
JPWR\_4P2**

## MSR/Card Reader Connector

PS/2\_2: MSR/Card reader connectors

PIN	ASSIGNMENT
1	KB_CLK (Output)
2	KB_CLK_C (Input)
3	KB_DATA_C (Input)
4	KB_DATA (Output)
5	+5V
6	GND

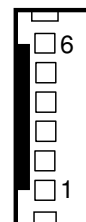

**PS/2\_2**

**Mini-PCIe / mSATA Connector****SLOT1:** Mini-PCIe connector, not support USB function

PIN	ASSIGNMENT	PIN	ASSIGNMENT
1	WAKE#	27	GND
2	+3.3V	28	+1.5V
3	Reserved	29	GND
4	GND	30	SMB_CLK
5	Reserved	31	PETn2
6	+1.5V	32	SMB_DATA
7	CLKREQ#	33	PETp2
8	Reserved	34	GND
9	GND	35	GND
10	Reserved	36	NC
11	REFCLK1-	37	GND
12	Reserved	38	NC
13	REFCLK1+	39	+3.3V
14	Reserved	40	GND
15	GND	41	+3.3V
16	Reserved	42	Reserved
17	Reserved	43	GND
18	GND	44	Reserved
19	Reserved	45	NC
20	Reserved	46	Reserved
21	GND	47	NC
22	PERST#	48	+1.5V
23	PERn2	49	NC
24	+3.3SB	50	GND
25	PERp2	51	Reserved
26	GND	52	+3.3V

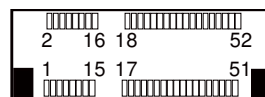
**SLOT1**



**SLOT2:** Mini-PCIe or mSATA connector, support USB function

PIN	ASSIGNMENT	PIN	ASSIGNMENT
1	WAKE#	27	GND
2	+3.3V	28	+1.5V
3	Reserved	29	GND
4	GND	30	SMB_CLK
5	Reserved	31	PETn0/SATA1_TX-
6	+1.5V	32	SMB_DATA
7	CLKREQ#	33	PETp0/SATA1_TX+
8	Reserved	34	GND
9	GND	35	GND
10	Reserved	36	USB_D-
11	REFCLK0-	37	GND
12	Reserved	38	USB_D+
13	REFCLK0+	39	+3.3V
14	Reserved	40	GND
15	GND	41	+3.3V
16	Reserved	42	Reserved
17	Reserved	43	GND
18	GND	44	Reserved
19	Reserved	45	NC
20	Reserved	46	Reserved
21	GND	47	NC
22	PERST#	48	+1.5V
23	PERn0/SATA1_RX+	49	NC
24	+3.3SB	50	GND
25	PERp0/SATA1_RX-	51	Reserved
26	GND	52	+3.3V

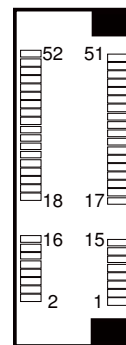

**SLOT2**

## 2-3. PRINTER BOARD COMPONENT LOCATIONS & PIN ASSIGNMENT

Printer Board: PDAC-3100

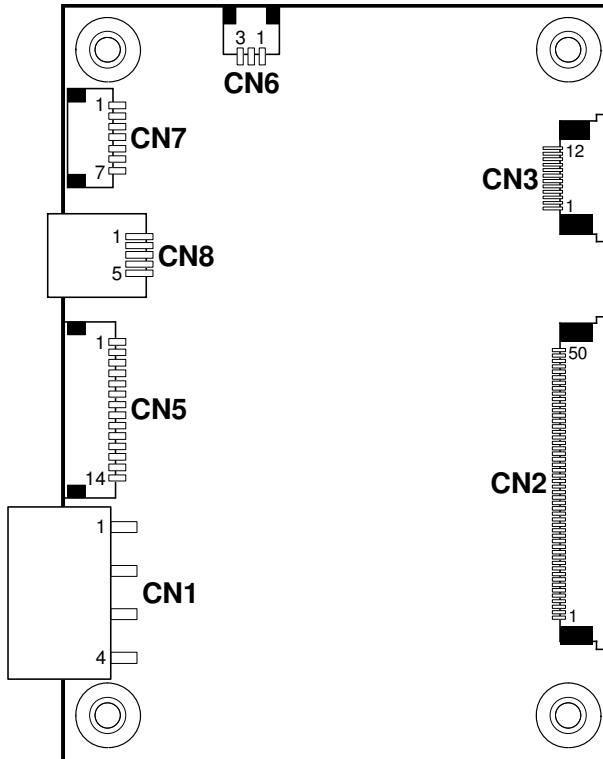

PDAC-3100 Printer Board Component Locations

### Power Supply Connector

CN1: Power supply wafer

PIN	ASSIGNMENT
1	+24V
2	+24V
3	GND
4	GND

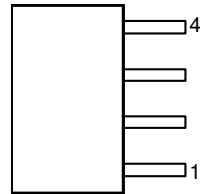

**CN1**

### RS-232 Interface Connector

CN7: RS-232 interface connector

PIN	ASSIGNMENT	PIN	ASSIGNMENT
1	TXD	5	DTR
2	RXD	6	DSR
3	RTS	7	GND
4	CTS		

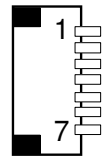

**CN7**

## Auto-Cutter Connector

**CN3:** Auto-cutter wafer

PIN	ASSIGNMENT	FUNCTION
1	NC	Unused
2	Vcs	Power supply of the home position sensor
3	GND	GND of the home position sensor
4	CUTS	Signal of the hom position sensor
5	2B-1	Auto-cutter motor drive signal
6	2B-2	Auto-cutter motor drive signal
7	2A-1	Auto-cutter motor drive signal
8	2A-2	Auto-cutter motor drive signal
9	1B-1	Auto-cutter motor drive signal
10	1B-2	Auto-cutter motor drive signal
11	1A-1	Auto-cutter motor drive signal
12	1A-2	Auto-cutter motor drive signal

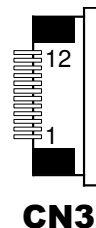

## USB Connector

**CN8:** USB Connector

PIN	ASSIGNMENT	PIN	ASSIGNMENT
1	Vbus	4	NC
2	D-	5	GND
3	D+		

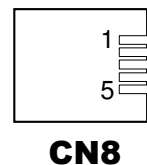

## Thermal Head/Motor/Sensor Connector

**CN2:** Thermal head/motor/sensor connector

PIN	ASSIGNMENT	FUNCTION
1	24V	Head drive power
2	24V	Head drive power
3	24V	Head drive power
4	24V	Head drive power
5	24V	Head drive power
6	24V	Head drive power
7	DAT	Print data output
8	CLK	Synchronizing signal for print data transfer
9	GND	Head GND
10	GND	Head GND
11	GND	Head GND
12	GND	Head GND
13	GND	Head GND
14	GND	Head GND
15	NC	Unused
16	DST4	Head strobe signal
17	DST3	Head strobe signal
18	3.3V	Logic Power
19	GND	Thermistor GND
20	GND	Thermistor GND
21	TH	Thermistor signal
22	NC	Unused
23	DST2	Head strobe signal
24	DST1	Head strobe signal
25	GND	Head GND
26	GND	Head GND
27	GND	Head GND
28	GND	Head GND
29	GND	Head GND

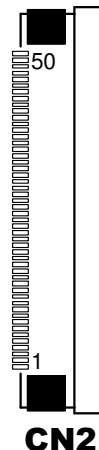

<b>PIN</b>	<b>ASSIGNMENT</b>	<b>FUNCTION</b>
30	GND	Head GND
31	LATCH	Print data latch
32	24V	Head drive power
33	24V	Head drive power
34	24V	Head drive power
35	24V	Head drive power
36	24V	Head drive power
37	24V	Head drive power
38	NC	Unused
39	PS	Signal of the out-of-paper sensor
40	Vps	Power supply of the out-of-paper sensor
41	GND	GND of the platen position/ out-of-paper sensor
42	HS	Signal of the platen position sensor
43	NC	Unused
44	FG	Frame GND
45	FG	Frame GND
46	NC	Unused
47	2A	Motor drive signal
48	1B	Motor drive signal
49	1A	Motor drive signal
50	2B	Motor drive signal

## Terminal Assignment Connector

**CN5:** Terminal assignment connector

PIN	ASSIGNMENT	FUNCTION
1	FEED	Feed signal
2	RESET	Reset signal
3	GND	GND
4	ST1	Status signal
5	ST2	Status signal
6	ST3	Status signal
7	ST4	Status signal
8	GND	GND
9	DRS	Drawer sensor signal
10	DSW	Drawer switch signal
11	Vdu	Drive terminal for the drawer (Vp side)
12	GNDdu	Drive terminal for the drawer (GND side)
13	GND	GND
14	NC	Unused

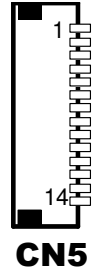

2-3-2. Printer Board: MB-1030F 6 ŽF7

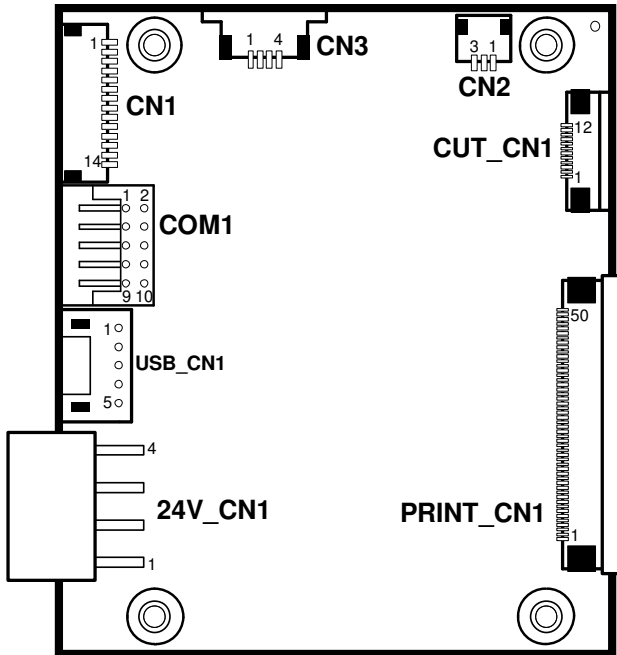

MB-1030TD, TE Printer Board Component Locations



### Power Supply Connector

**24V\_CN1:** Power Supply Wafer

PIN	ASSIGNMENT
1	GND
2	GND
3	+24V
4	+24V

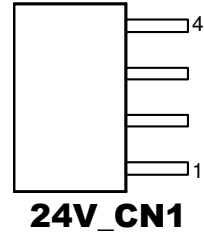

### RS-232 Interface Connector

**COM1:** RS-232 Interface Connector

PIN	ASSIGNMENT	PIN	ASSIGNMENT
1	NC	6	DSR /CTS
2	RXD	7	RTS
3	TXD	8	CTS
4	DTR /RTS	9	NC
5	GND	10	NC

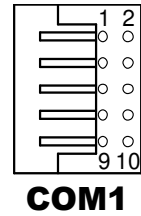

**Thermal Head/Motor/Sensor Connector**

**PRINT\_CN1:** Thermal head/motor/sensor connector

PIN	ASSIGNMENT	FUNCTION
1	24V	Head drive power
2	24V	Head drive power
3	24V	Head drive power
4	24V	Head drive power
5	24V	Head drive power
6	24V	Head drive power
7	DAT	Print data output
8	CLK	Synchronizing signal for print data transfer
9	GND	Head GND
10	GND	Head GND
11	GND	Head GND
12	GND	Head GND
13	GND	Head GND
14	GND	Head GND
15	NC	Unused
16	DST4	Head strobe signal
17	DST3	Head strobe signal
18	3.3V	Logic Power
19	GND	Thermistor GND
20	GND	Thermistor GND
21	TH	Thermistor signal
22	NC	Unused
23	DST2	Head strobe signal
24	DST1	Head strobe signal
25	GND	Head GND
26	GND	Head GND
27	GND	Head GND
28	GND	Head GND
29	GND	Head GND

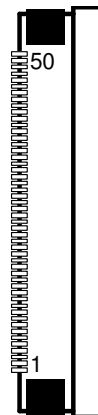

**PRINT\_CN1**

<b>PIN</b>	<b>ASSIGNMENT</b>	<b>FUNCTION</b>
30	GND	Head GND
31	LATCH	Print data latch
32	24V	Head drive power
33	24V	Head drive power
34	24V	Head drive power
35	24V	Head drive power
36	24V	Head drive power
37	24V	Head drive power
38	NC	Unused
39	PS	Signal of the out-of-paper sensor
40	Vps	Power supply of the out-of-paper sensor
41	GND	GND of the platen position/ out-of-paper sensor
42	HS	Signal of the platen position sensor
43	NC	Unused
44	FG	Frame GND
45	FG	Frame GND
46	NC	Unused
47	2A	Motor drive signal
48	1B	Motor drive signal
49	1A	Motor drive signal
50	2B	Motor drive signal

## Auto-Cutter Connector

**CUT\_CN1:** Auto-cutter Connector

PIN	ASSIGNMENT	FUNCTION
1	NC	Unused
2	Vcs	Power supply of the home position sensor
3	GND	GND of the home position sensor
4	CUTS	Signal of the hom position sensor
5	2B-1	Autocutter motor drive signal
6	2B-2	Autocutter motor drive signal
7	2A-1	Autocutter motor drive signal
8	2A-2	Autocutter motor drive signal
9	1B-1	Autocutter motor drive signal
10	1B-2	Autocutter motor drive signal
11	1A-1	Autocutter motor drive signal
12	1A-2	Autocutter motor drive signal

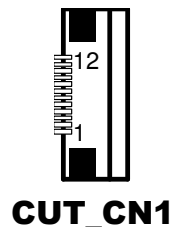

## Paper-Near-END Sensor Connector

**CN2:** Paper-near-end sensor connector

PIN	ASSIGNMENT	FUNCTION
1	Vns	Power supply of the near end sensor
2	NS	Signal of the near end sensor
3	GND	GND of the near end sensor



### USB Interface Connector

**USB\_CN1:** USB interface connector

PIN	ASSIGNMENT	PIN	ASSIGNMENT
1	Vbus	4	GND
2	D-	5	GND
3	D+		

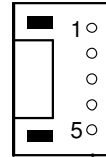

**USB\_CN1**

### Terminal Assignment Connector

**CN1:** Terminal assignment connector

PIN	ASSIGNMENT	FUNCTION
1	FEED	Feed signal
2	RESET	Reset signal
3	GND	GND
4	ST1	Status signal
5	ST2	Status signal
6	ST3	Status signal
7	ST4	Status signal
8	GND	GND
9	DRS	Drawer sensor signal
10	DSW	Drawer switch signal
11	Vdu	Drive terminal for the drawer (Vp side)
12	GNDdu	Drive terminal for the drawer (GND side)
13	GND	GND
14	NC	Unused

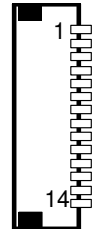

**CN1**

2-3-3. Printer Board: MB-1011 & MB-1013

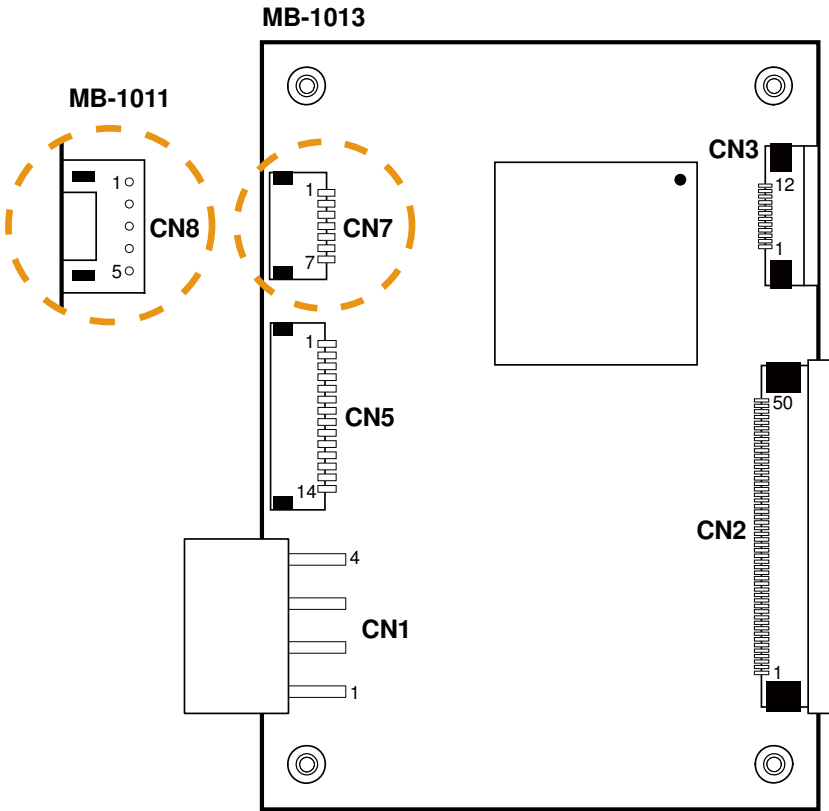

MB-1011 & MB-1013 Printer Board Component Locations

### Power Supply Connector

**CN1:** Power supply wafer

PIN	ASSIGNMENT
1	GND
2	GND
3	+24V
4	+24V

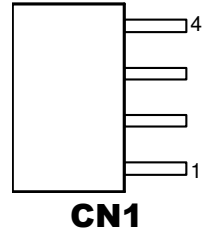

### RS-232 Interface Connector

**CN7:** RS-232 interface connector

PIN	ASSIGNMENT	PIN	ASSIGNMENT
1	TXD	5	DTR
2	RXD	6	DSR
3	RTS	7	GND
4	CTS		

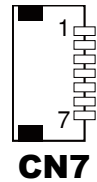

## Thermal Head/Motor/Sensor Connector

**CN2:** Thermal head/motor/sensor connector

PIN	ASSIGNMENT	FUNCTION
1	24V	Head drive power
2	24V	Head drive power
3	24V	Head drive power
4	24V	Head drive power
5	24V	Head drive power
6	24V	Head drive power
7	DAT	Print data output
8	CLK	Synchronizing signal for print data transfer
9	GND	Head GND
10	GND	Head GND
11	GND	Head GND
12	GND	Head GND
13	GND	Head GND
14	GND	Head GND
15	NC	Unused
16	DST4	Head strobe signal
17	DST3	Head strobe signal
18	3.3V	Logic Power
19	GND	Thermistor GND
20	GND	Thermistor GND
21	TH	Thermistor signal
22	NC	Unused
23	DST2	Head strobe signal
24	DST1	Head strobe signal
25	GND	Head GND
26	GND	Head GND
27	GND	Head GND
28	GND	Head GND
29	GND	Head GND

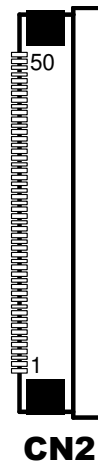



<b>PIN</b>	<b>ASSIGNMENT</b>	<b>FUNCTION</b>
30	GND	Head GND
31	LATCH	Print data latch
32	24V	Head drive power
33	24V	Head drive power
34	24V	Head drive power
35	24V	Head drive power
36	24V	Head drive power
37	24V	Head drive power
38	NC	Unused
39	PS	Signal of the out-of-paper sensor
40	Vps	Power supply of the out-of-paper sensor
41	GND	GND of the platen position/ out-of-paper sensor
42	HS	Signal of the platen position sensor
43	NC	Unused
44	FG	Frame GND
45	FG	Frame GND
46	NC	Unused
47	2A	Motor drive signal
48	1B	Motor drive signal
49	1A	Motor drive signal
50	2B	Motor drive signal

## Auto-Cutter Connector

### CN3: Auto-cutter Connector

PIN	ASSIGNMENT	FUNCTION
1	NC	Unused
2	Vcs	Power supply of the home position sensor
3	GND	GND of the home position sensor
4	CUTS	Signal of the hom position sensor
5	2B-1	Autocutter motor drive signal
6	2B-2	Autocutter motor drive signal
7	2A-1	Autocutter motor drive signal
8	2A-2	Autocutter motor drive signal
9	1B-1	Autocutter motor drive signal
10	1B-2	Autocutter motor drive signal
11	1A-1	Autocutter motor drive signal
12	1A-2	Autocutter motor drive signal



**CN3**

## USB Interface Connector

### CN8: USB interface connector

PIN	ASSIGNMENT
1	Vbus
2	D-
3	D+
4	GND
5	GND

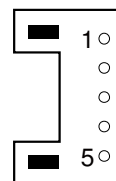

**CN8**

**Terminal Assignment Connector**

**CN5:** Terminal assignment connector

PIN	ASSIGNMENT	FUNCTION
1	FEED	Feed signal
2	RESET	Reset signal
3	GND	GND
4	ST1	Status signal
5	ST2	Status signal
6	ST3	Status signal
7	ST4	Status signal
8	GND	GND
9	DRS	Drawer sensor signal
10	DSW	Drawer switch signal
11	Vdu	Drive terminal for the drawer (Vp side)
12	GNDdu	Drive terminal for the drawer (GND side)
13	GND	GND
14	NC	Unused

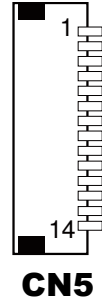

## 2-4. VFD BOARD COMPONENT LOCATIONS & PIN ASSIGNMENT

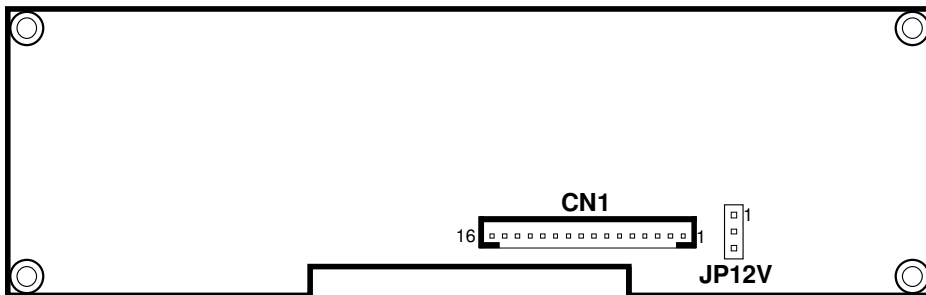

VFD Board: MB-4103, LD720



MB-4103 & LD720 VFD Board Component Locations

### Power Switch Selection

#### JP12V: Power Switch Selection

SELECTION	JUMPER SETTING	JUMPER ILLUSTRATION
OFF	1-2	 <p><b>JP12V</b></p>
ON	2-3	 <p><b>JP12V</b></p>

Note: Manufacturing Default is ON.

### RS-232 Serial Interface Connector

#### CN1: RS-232 serial interface wafer

PIN	ASSIGNMENT	PIN	ASSIGNMENT
1	GND	9	NC
2	TXD	10	NC
3	RXD	11	NC
4	DTR	12	NC
5	DSR	13	NC
6	RTS	14	NC
7	CTS	15	NC
8	+12V/+5V	16	NC

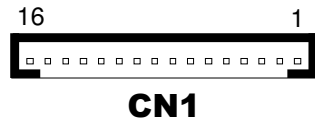

## 2-5. MSR BOARD COMPONENT LOCATIONS & PIN ASSIGNMENT

### ID TECH

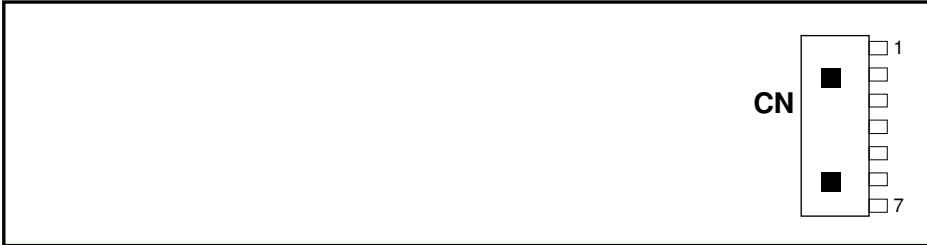

ID-TECH MSR Board Component Locations

### Main Connector

CN:

PIN	ASSIGNMENT	PIN	ASSIGNMENT
1	Chassis Ground	5	K-CLK (Computer connections)
2	P-CLK (Keyboard connections)	6	K-DATA (Computer connections)
3	P-DATA (Keyboard connections)	7	GND
4	+5V Vcc		

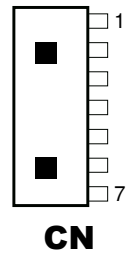

**MB-3012**



**MB-3012 MSR Board Component Locations**

**Information Button Reader**

**I\_BUTTON1:** Information button reader

PIN	ASSIGNMENT
1	I_B1
2	GND

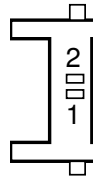

**I-BUTTON1**

**Output Connector**

**IO1:** Output wafer

PIN	ASSIGNMENT	PIN	ASSIGNMENT
1	CLK_KB	7	RX_MSR
2	CLK_PC	8	TX_MSR
3	DATA_KB	9	GND
4	DATA_PC	10	USB_D+_R
5	+5V	11	USB_D-_R
6	CHASSIS GND	12	GND



**IO1**

## 4. Secondary Cash Drawer

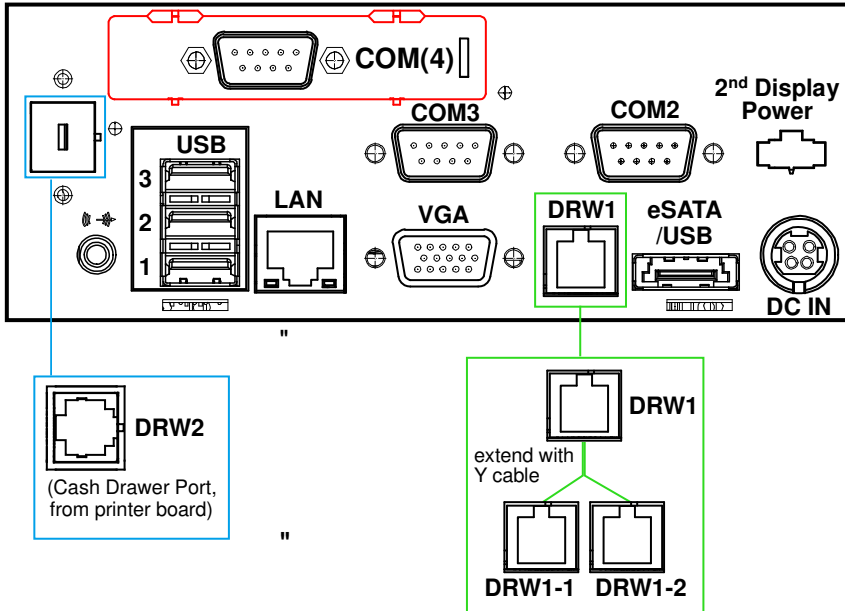



4-1 DRW1-2 Port (Only for PA-6822RC)

DRW1 is used by default. If you need a second port, adopt either way below.

Step.1

DRW1 includes two groups of GPIO pins. The second group is normally unused but can be enabled by the jumper.

Set the pin-header jumper JP37 as 1-2 connected if necessary.

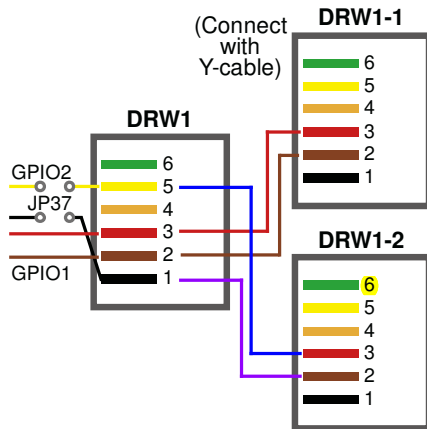

**JP37:** DRW1-2 control connector

SELECTION	JUMPER SETTING	JUMPER ILLUSTRATION
DRW1-2 Open	1-2	<p><b>JP37</b></p>
GND	2-3	<p><b>JP37</b></p>

**Note:** Manufacturing Default is GND.

Step.2

You can split DRW1 into two channels of DRW1-1 & DRW1-2 with the Y-Cable(optional unit).

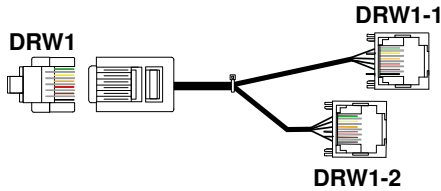

DRW1, DRW1-1, DRW1-2: Signal from M/B GPIO (rear I/O)

Step.3

DRW1, DRW1-1, DRW1-2 shares the same power source (refer to Cash Drawer Power Selection for adjustment, default at 12V).

PIN	ASSIGNMENT	PIN	ASSIGNMENT
1	GND	4	+12V/+24V (Max. current: 1A)
2	Drawer Open	5	NC
3	Drawer Sense	6	GND

À

DRW1-1	OPEN		CLOSE	
PB-6822RA,RB	Write	To	Write	To
	700h	588h	000h	588h
PB-6822RC	Write	To	Write	To
	02h	SIO LDN 06h's 90h	00h	SIO LDN 06h's 90h
DRW1-2	OPEN		CLOSE	
PB-6822RA,RB	Write	To	Write	To
	N/A	N/A	N/A	N/A
PB-6822RC	Write	To	Write	To
	04h	SIO LDN 06h's 90h	00h	SIO LDN 06h's 90h

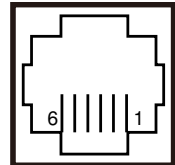

**DRW1/  
DRW1-1/  
DRW1-2**

4-2 DRW2 Port (Only support PA-6822 selected "Printer kit")

Signal from printer board (MB-1030, MB-1011(3), PDAC3100) and be controlled by command. DRW2 port on the bottom of Stand with a cable (optional).

PIN	ASSIGNMENT	PIN	ASSIGNMENT
1	GND	4	+24V
2	Drawer Open	5	NC
3	Drawer Sense	6	GND

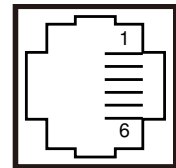

**DRW2**

Control Codes	Hexadecimal Codes	Function
<DLE EOT>	10 04	Real-time status transmission
<DLE DC4>	10 14	Real-time output of specified pulse

# ***SOFTWARE***

CHAPTER

**3**

This chapter provides the detailed information of driver utilities and BIOS settings for the system.

Sections included:

- Driver
  - Intel® Chipset Software Installation Utility
  - VGA Driver Utility
  - LAN Driver Utility
  - Sound Driver Utility
  - Touchscreen Driver Utility
  - Fingerprinter Driver Utility (Optional)
  - RFID Module Driver (Optional)
  - Wireless Module Driver (Optional)
  
- Embedded Peripheral Device
  - Printer
  - VFD
  - MSR
  
- API
  
- BIOS Operation
  - Setup
  - Watchdog Timer Configuration
  - Update Procedure
  - System Resource Map

## 3-1. DRIVER DISC

### 3-1-1. Introduction

Enclosed with the PA-6622 Series package is our driver utilities, which comes in a CD-ROM format.

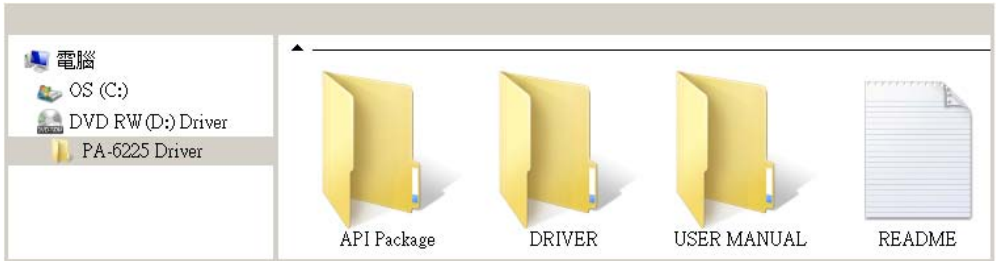

#### 3-1-2-1. API Package folder

Refer to the "3-3 API" for the details.

```
+--->\DEMO PROJECT\  
+--->\ProxAPI standard\  
+--->\Document\  

```

#### 3-1-2-2. DRIVER folder

1. The sequence of setup is "Main Chip -> VGA -> LAN -> SOUND -> TOUCH[Device folder]"
2. You will be prompted to reboot when installation is complete.

```
+--->\Flash BIOS\AFUa.bat  
+--->\Plaform\  
+--->\Device\  

```

#### 3-1-2-' . I G9F `A5 BI 5 @z`XYf

\AdbeRdr930\_en\_US.exe (PDF File reader)

#### 3-1-2-( . F95 8 A9

The DRIVER DISC introduction

### **3-1-3. Intel® Chipset Software Installation Utility**

#### **3-1-3-1. Introduction**

The Intel® Chipset Software Installation Utility installs Windows \*.INF files to the target system. These files outline to the operating system how to configure the Intel chipset components in order to ensure the following features function properly:

- SATA Storage Support (SATA & SATA II)
- USB Support (1.1 & 2.0)
- Identification of Intel® Chipset Components in Device Manager

#### **3-1-3-2. Installation of Intel® Chipset Driver**

The utility pack is to be installed only for POSReady 7 & Embedded 8 Industry series, and it should be installed right after the OS installation. Please follow the steps below:

1. Connect the USB CD-ROM device to PA-6622 and insert the driver disk.
2. Enter the “Main Chip” folder where the Chipset driver is located (depending on your OS platform).
3. Click **Setup.exe** file for driver installation.
4. Follow the on-screen instructions to complete the installation.
5. Once installation is completed, shut down the system and restart PA-6622 for the changes to take effect.

### **3-1-4. VGA Driver Utility**

The VGA interface embedded with PA-6622 can support a wide range of display types. You can have dual displays via CRT & LVDS interfaces work simultaneously.

#### **3-1-4-1. Installation of VGA Driver**

To install the Graphics driver, follow the steps below:

1. Connect the USB-CD ROM device to PA-6622 and insert the driver disk.
2. Enter the “VGA” folder where the VGA driver is located (depending on your OS platform).
3. Click **Setup.exe** file for driver installation.
4. Follow the on-screen instructions to complete the installation.
5. Once installation is completed, shut down the system and restart PA-6622 for the changes to take effect.

### **3-1-5. LAN Driver Utility**

PA-6622 is enhanced with LAN function that can support various network adapters. Installation platform for the LAN driver is listed as follows:

#### **3-1-5-1. Installation of LAN Driver**

To install the LAN Driver, follow the steps below:

1. Connect the USB CD-ROM device to PA-6622 and insert the driver disk.
2. Enter the “LAN” folder where the LAN driver is located (depending on your OS platform).
3. Click **Setup.exe** file for driver installation.
4. Follow the on-screen instructions to complete the installation.
5. Once installation is completed, shut down the system and restart PA-6622 for the changes to take effect.

**For more details on the Installation procedure, please refer to the Readme.txt file found on LAN Driver Utility.**

### **3-1-6. Sound Driver Utility**

The sound function enhanced in this system is fully compatible with Windows POSReady 7 & Embedded 8 Industry series. Below, you will find the content of the Sound driver.

#### **3-1-6-1. Installation of Sound Driver**

To install the Sound Driver, follow the steps below:

1. Connect the USB CD-ROM device to PA-6622 and insert the driver disk.
2. Enter the “Sound” folder where the sound driver is located (depending on your OS platform).
3. Click **Setup.exe** file for driver installation.
4. Follow the on-screen instructions to complete the installation.
5. Once installation is completed, shut down the system and restart PA-6622 for the changes to take effect.

### **3-1-7. Touchscreen Driver Utility**

The touchscreen driver utility can only be installed on Windows POSReady 7 & Embedded 8 Industry series, and it should be installed right after the OS installation.

#### **3-1-7-1. Installation of Touchscreen Driver**

To install the touchscreen driver, follow the steps below:

1. Connect the USB CD-ROM device to PA-6622 and insert the driver disk.
2. Enter the “Device\Touch Screen” folder where the touchscreen driver is located.
3. Click **Setup.exe** file for driver installation.
4. Follow the on-screen instructions to complete the installation.
5. Once installation is completed, shut down the system and restart PA-6622 for the changes to take effect.



### **3-1-8. Fingerprinter Driver Utility (Optional)**

The fingerprinter driver utility can only be installed on a Windows platform, and it should be installed right after the OS installation.

#### **3-1-8-1. Installation of Fingerprinter Driver**

To install the fingerprinter driver, follow the steps below:

1. Connect the USB CD-ROM device to PA-6622 and insert the driver disk.
2. Enter the “Device\Embedded Finger Printer” folder where the fingerprinter driver is located.
3. Click **Setup.exe** file for driver installation.
4. Follow the on-screen instructions to complete the installation.
5. Once installation is completed, shut down the system and restart PA-6622 for the changes to take effect.

### **3-1-9. RFID Module Driver Utility (Optional)**

The RFID driver utility can only be installed on Windows POSReady7 & Embedded 8 industry series, and it should be installed right after the OS installation.

#### **3-1-9-1. Installation of RFID Module Driver**

To install the fingerprinter driver, follow the steps below:

1. Connect the USB CD-ROM device to PA-6622 and insert the driver disk.
2. Enter the “Device\RFID Module” folder where the RFID Module driver is located.
3. Click **Autorun.exe** file for driver installation.
4. Select **Mifare Demo Software V1.5R8**.
5. Follow the on-screen instructions to complete the installation.
6. Once installation is completed, shut down the system and restart PA-6622 for the changes to take effect.

### **3-1-10. Wireless Module Driver Utility (Optional)**

The wireless driver utility can only be installed on Windows POSReady7 & Embedded 8 Industry series, and it should be installed right after the OS installation.

#### **3-1-10-1. Installation of Wireless Driver**

To install the wireless driver, follow the steps below:

1. Connect the USB CD-ROM device to PA-6622 and insert the driver disk.
2. Enter the “Device\Embedded Wireless Module” folder where the wireless driver is located.
3. Click **Setup.exe** file for driver installation.
4. Follow the on-screen instructions to complete the installation.
5. Once installation is completed, shut down the system and restart PA-6622 for the changes to take effect.

## **3-2. PERIPHERAL DEVICES**

Command lists and driver installation guide for peripheral devices of the system - printer board, VFD and MSR – are explicitly included in this section.

### **3-2-1. Printer Board: MB-1030**

#### **3-2-1-1. Command**

1. Printer Registry Operation

<b>Registry Name</b>	<b>Default Data</b>	<b>Notes</b>
BaudRate	115200	-
BitLength	8	-
Parity	N	-
Stop	1	-

2. Command List

**Standard commands**

Command	RA	RB	Command	RA	RB	Command	RA	RB
HT		V	ESC D		V	GS /	V	V
LF	V	V	ESC E	V	V	GS :		
FF		V	ESC G		V	GS B	V	V
CR	V	V	ESC J	V	V	GS H	V	V
CAN		V	ESC L		V	GS I	V	V
DLE EOT	V	V	ESC M	V	V	GS L	V	V
DLE ENQ		V	ESC c 4		V	GS P	V	V
DLE DC4	V	V	ESC c 5		V	GS V	V	V
ESC FF		V	ESC d	V	V	GS W		V
ESC SP	V	V	ESC p	V	V	GS \		
ESC !	V	V	ESC i	V	V	GS ^		
ESC \$	V	V	ESC {	V	V	GS a	V	V
ESC %			FS g 1			GS b		
ESC &			FS g 2			GS f	V	V
ESC *		V	FS p	V	V	GS h	V	V
ESC -	V	V	FS q	V	V	GS k	V	V
ESC 2	V	V	GS !	V	V	GS r	V	V
ESC 3	V	V	GS \$		V	GS v 0	V	V
ESC =	V	V	GS *	V	V	GS w	V	V
ESC ?			GS ( A	V	V			
ESC @	V	V	GS ( K		V			

**Kanji Control Commands**

Command	MB-1030 RA	MB-1030 RB
FS I	V	V
FS &	V	V
FS -		V
FS .	V	V
FS 2		
FS C		
FS S		V
FS W		V

**Other Commands**

Command	MB-1030 RA	MB-1030 RB
ESC i	V	V
ESC m	V	V
DC2 :		V
GS p 1		V

# COMMAND LIST

## Standard Commands

Control Codes	Hexadecimal Codes	Function	Standard Mode	Page Mode
<HT>	09	Horizontal tab	V	V
<LF>	0A	Print and line feed	V	V
<FF>	0C	Print and recover to standard mode (in page mode)	Ignored	V
<CR>	0D	Print and carriage return	V	V
<CAN>	18	Cancel print data in page mode	Ignored	V
<DLE EOT>	10 04	Real-time status transmission	V	V
<DLE ENQ>	10 05	Real-time request to printer	V	V
<DLE DC4>	10 14	Real-time output of specified pulse	V	V
<ESC FF>	1B 0C	Print data in page mode	Ignored	V
<ESC SP>	1B 20	Set right-side character spacing	V	V
<ESC !>	1B 21	Select print mode(s)	V	V
<ESC \$>	1B 24	Set absolute print position.	V	V
<ESC *>	1B 2A	Select bit image mode	V	V
<ESC ->	1B 2D	Turn underline mode on/off.	V	V
<ESC 2>	1B 32	Select default line spacing	V	V
<ESC 3>	1B 33	Set line spacing	V	V
<ESC =>	1B 3D	Select peripheral device	V	V
<ESC @>	1B 40	Initialize printer	V	V
<ESC D>	1B 44	Set horizontal tab position	V	V
<ESC E>	1B 45	Turn emphasized mode on/off	V	V
<ESC G>	1B 47	Turn double-strike mode on/off	V	V
<ESC J>	1B 4A	Print and feed paper	V	V
<ESC L>	1B 4C	Select page mode	⊙	Ignored
<ESC M >	1B 4D	Select character font	V	V
<ESC R>	1B 52	Select an international character set	V	V
<ESC S>	1B 53	Select standard mode	Ignored	V
<ESC T>	1B 54	Select print direction in page mode	▲	V
<ESC V>	1B 56	Turn 90 degree clockwise rotation mode on/off	V	▲
<ESC W>	1B 57	Set printing area in page mode	▲	V
<ESC \>	1B 5C	Set relative print position	V	V
<ESC a>	1B 61	Select justification	⊙	▲
<ESC c 3>	1B 63 33	Select paper sensor(s) to output paper-en signals	V	V
<ESC c 4>	1B 63 34	Select paper sensor(s) to stop printing	V	V
<ESC c 5>	1B 63 35	Enable/disable panel buttons	V	V
<ESC d>	1B 64	Print and feed n lines	V	V
<ESC i>	1B 69	Full cut	V	Disabled
<ESC m>	1B 6D	Partial cut	V	Disabled
<ESC p>	1B 70	General pulse	V	V
<ESC t>	1B 74	Select character code table	V	V

<ESC {>	1B 7B	Turn upside-down printing mode on/off	☉	▲
<FS p>	1C 70	Print NV bit image	V	Disabled
<FS q>	1C 71	Define NV bit image	☉	Disabled
<GS !>	1D 21	Select character size		V
<GS \$>	1D 24	Set absolute vertical print position in page mode	Ignored	V
<GS *>	1D 2A	Define download bit images	V	V
<GS ( A>	1D 28 41	Execute test print	V	Disabled
<GS ( K>	1D 28 4B	Set print density	V	Disabled
<GS />	1D 2F	Print download bit image	●	V
<GS B>	1D 42	Turn white/black reverse printing mode on/off	V	V
<GS H>	1D 48	Select printing position of HRI characters	V	V
<GS l>	1D 49	Transmit printer ID	V	Disabled
<GS L>	1D 4C	Set left margin	☉	Disabled
<GS P>	1D 50	Set basic calculated pitch	V	V
<GS V>	1D 56	Cut paper	☉	V
<GS W>	1D 57	Set printing area width	☉	▲
<GS \>	1D 5C	Set relative vertical print position in page mode	Ignored	
<GS a>	1D 61	Enable/disable Automatic Status Back (ASB)	V	V
<GS f>	1D 66	Select font for HRI characters	V	V
<GS h>	1D 68	Set bar code height	V	V
<GS k>	1D 6B	Print bar code	●	V
<GS r>	1D 72	Transmit status	V	V
<GS v 0>	1D 76 30	Print raster bit image	●	Disabled
<GS w>	1D 77	Set bar code width	V	V

## Two-dimensional Bar Code Commands

Control Codes	Hexadecimal Codes	Function	Standard Mode	Page Mode
<DC2 ;>	12 3B	Specifies a module size of QR Code and Data Matrix	V	V
<GS p 1>	1D 70 01	Prints QRCode data based on the specified contents	V	V

## Kanji Control Commands

(when the Japanese, Simplified Chinese, Traditional Chinese, or Korean model is used)

Control Codes	Hexadecimal Codes	Function	Standard Mode	Page Mode
<FS l>	1C 21	Set print mode(s) for Kanji characters	V	V
<FS &>	1C 26	Select Kanji character mode	V	V
<FS ->	1C 2D	Turn underline mode on/off for Kanji characters	V	V
<FS .>	1C 2E	Cancel Kanji character mode	V	V
<FS S>	1C 53	Set Kanji character spacing	V	V
<FS W>	1C 57	Turn quadruple-size mode on/off for Kanji characters	V	V

### Command classification

Executing : Printer executes the command, which does not then affect the following data.

Setting : Printer uses flags to make settings, and those settings affect the following data.

○: Enabled.

⊙: Enabled only when the command is set at the beginning of a line.

●: Enabled only when data is not present in the printer buffer.

▲: Only value setting is possible.

Disabled: Parameters are processed as printable data.

Ignored: All command codes including parameters are ignored and nothing is executed.

## COMMAND DETAILS

### STANDARD COMMAND DETAILS

#### HT

[Name]	Horizontal tab
[Format]	ASCII HT Hex. 09 Decimal 9
[Range]	N/A
[Description]	<p>Moves print position to next horizontal tab position.</p> <ul style="list-style-type: none"> <li>● This command is ignored if the next tab is not set.</li> <li>● If the next tab position exceeds the print region, the print position is moved to [print region + 1].</li> <li>● The horizontal tab position is set by ESC D (Set/cancel horizontal tab position).</li> <li>● When the print position is at the [print region + 1] position and this command is received, the current line buffer full is printed and a horizontal tab is executed from the top of the next line.</li> <li>● The initial value of the horizontal tab position is every 8 characters of Font A (the 9th, 17th, 25<sup>th</sup> positions, etc.)</li> </ul>

## LF

[Name]	Print and line feed
[Format]	ASCII LF Hex. 0A Decimal 10
[Range]	N/A
[Description]	Prints the data in the print buffer and performs a line feed based on the set line feed amount. <ul style="list-style-type: none"> <li>● After execution, makes the top of the line the next print starting position.</li> </ul>

## FF

[Name]	Print and recover to standard mode (in page mode)
[Format]	ASCII FF Hex. 0C Decimal 12
[Range]	N/A
[Description]	Prints all buffered data to the print region collectively, then recovers to the standard mode. <ul style="list-style-type: none"> <li>● All buffer data is deleted after printing.</li> <li>● The print area set by ESC W (Set print region in page mode) is reset to the default setting.</li> <li>● No paper cut is executed.</li> <li>● Sets the print position to the beginning of the next line after execution.</li> <li>● This command is enabled only in page mode.</li> </ul>

## CR

[Name]	Print and carriage return
[Format]	ASCII CR Hex. 0D Decimal 13
[Range]	N/A
[Description]	When an automatic line feed is enabled, this command functions in the same way as LF(print and line feed). When the automatic line feed is disabled, this command is ignored. <ul style="list-style-type: none"> <li>● This command is ignored with serial interface models.</li> <li>● Sets the print position to the beginning of the next line after execution.</li> </ul>

## CAN

[Name]	Cancel print data in page mode
[Format]	ASCII CAN Hex. 18 Decimal 24
[Range]	N/A
[Description]	Deletes all print data in the currently set print region in page mode. <ul style="list-style-type: none"> <li>● This command is enabled only in page mode.</li> <li>● Portions included in the currently set print region are also deleted, even if previously set print region data.</li> </ul>

**DLE EOT n**

[Name]	Real-time status transmission.																																																																																																																																																											
[Format]	ASCII OLE EOT n Hex. 10 04 n Decimal 16 4 n																																																																																																																																																											
[Range]	$1 \leq n \leq 4$																																																																																																																																																											
[Description]	<p>Transmits the selected printer status specified by n in real time, according to the following parameters:  n = 1 : Transmit printer status. n = 2 : Transmit off-line status.  n = 3 : Transmit error status. n = 4 : Transmit paper roll sensor status.</p> <p>n = 1 : Printer status.</p> <table border="1"> <thead> <tr> <th>Bit</th> <th>On / Off</th> <th>Hex</th> <th>Decimal</th> <th>Function</th> </tr> </thead> <tbody> <tr> <td>0</td> <td>Off</td> <td>00</td> <td>0</td> <td>Not used. Fixed to Off.</td> </tr> <tr> <td>1</td> <td>On</td> <td>02</td> <td>2</td> <td>Not used. Fixed to On.</td> </tr> <tr> <td rowspan="2">2</td> <td>Off</td> <td>00</td> <td>0</td> <td>Drawer open/close signal is LOW.</td> </tr> <tr> <td>On</td> <td>04</td> <td>4</td> <td>Drawer open/close signal is HIGH.</td> </tr> <tr> <td rowspan="2">3</td> <td>Off</td> <td>00</td> <td>0</td> <td>On-line.</td> </tr> <tr> <td>On</td> <td>08</td> <td>8</td> <td>Off-line.</td> </tr> <tr> <td>4</td> <td>On</td> <td>10</td> <td>16</td> <td>Not used. Fixed to On.</td> </tr> <tr> <td>5</td> <td>Off</td> <td>00</td> <td>0</td> <td>Not used. Fixed to Off.</td> </tr> <tr> <td>6</td> <td>Off</td> <td>00</td> <td>0</td> <td>Not used. Fixed to Off.</td> </tr> <tr> <td>7</td> <td>Off</td> <td>00</td> <td>0</td> <td>Not used. Fixed to Off.</td> </tr> </tbody> </table> <p>n = 2 : Off-line status.</p> <table border="1"> <thead> <tr> <th>Bit</th> <th>On / Off</th> <th>Hex</th> <th>Decimal</th> <th>Function</th> </tr> </thead> <tbody> <tr> <td>0</td> <td>Off</td> <td>00</td> <td>0</td> <td>Not used. Fixed to Off.</td> </tr> <tr> <td>1</td> <td>On</td> <td>02</td> <td>2</td> <td>Not used. Fixed to On.</td> </tr> <tr> <td rowspan="2">2</td> <td>Off</td> <td>00</td> <td>0</td> <td>Cover is closed.</td> </tr> <tr> <td>On</td> <td>04</td> <td>4</td> <td>Cover is open.</td> </tr> <tr> <td>3</td> <td>Off</td> <td>00</td> <td>0</td> <td>Not used. Fixed to Off.</td> </tr> <tr> <td>4</td> <td>On</td> <td>10</td> <td>16</td> <td>Not used. Fixed to On.</td> </tr> <tr> <td rowspan="2">5</td> <td>Off</td> <td>00</td> <td>0</td> <td>No paper-end stop.</td> </tr> <tr> <td>On</td> <td>20</td> <td>32</td> <td>Printing stops due to paper end.</td> </tr> <tr> <td rowspan="2">6</td> <td>Off</td> <td>00</td> <td>0</td> <td>No error.</td> </tr> <tr> <td>On</td> <td>40</td> <td>64</td> <td>Error occurs.</td> </tr> <tr> <td>7</td> <td>Off</td> <td>00</td> <td>0</td> <td>Not used. Fixed to Off.</td> </tr> </tbody> </table> <p>n = 3 : Error status</p> <table border="1"> <thead> <tr> <th>Bit</th> <th>On / Off</th> <th>Hex</th> <th>Decimal</th> <th>Function</th> </tr> </thead> <tbody> <tr> <td>0</td> <td>Off</td> <td>00</td> <td>0</td> <td>Not used. Fixed to Off.</td> </tr> <tr> <td>1</td> <td>On</td> <td>02</td> <td>2</td> <td>Not used. Fixed to On.</td> </tr> <tr> <td>2</td> <td>Off</td> <td>00</td> <td>0</td> <td>Not used. Fixed to Off.</td> </tr> <tr> <td>3</td> <td>Off</td> <td>00</td> <td>0</td> <td>Not used. Fixed to Off.</td> </tr> <tr> <td>4</td> <td>On</td> <td>10</td> <td>16</td> <td>Not used. Fixed to On.</td> </tr> <tr> <td>5</td> <td>Off</td> <td>00</td> <td>0</td> <td>Not used. Fixed to Off.</td> </tr> <tr> <td>6</td> <td>Off</td> <td>00</td> <td>0</td> <td>Not used. Fixed to Off.</td> </tr> <tr> <td>7</td> <td>Off</td> <td>00</td> <td>0</td> <td>Not used. Fixed to Off.</td> </tr> </tbody> </table>	Bit	On / Off	Hex	Decimal	Function	0	Off	00	0	Not used. Fixed to Off.	1	On	02	2	Not used. Fixed to On.	2	Off	00	0	Drawer open/close signal is LOW.	On	04	4	Drawer open/close signal is HIGH.	3	Off	00	0	On-line.	On	08	8	Off-line.	4	On	10	16	Not used. Fixed to On.	5	Off	00	0	Not used. Fixed to Off.	6	Off	00	0	Not used. Fixed to Off.	7	Off	00	0	Not used. Fixed to Off.	Bit	On / Off	Hex	Decimal	Function	0	Off	00	0	Not used. Fixed to Off.	1	On	02	2	Not used. Fixed to On.	2	Off	00	0	Cover is closed.	On	04	4	Cover is open.	3	Off	00	0	Not used. Fixed to Off.	4	On	10	16	Not used. Fixed to On.	5	Off	00	0	No paper-end stop.	On	20	32	Printing stops due to paper end.	6	Off	00	0	No error.	On	40	64	Error occurs.	7	Off	00	0	Not used. Fixed to Off.	Bit	On / Off	Hex	Decimal	Function	0	Off	00	0	Not used. Fixed to Off.	1	On	02	2	Not used. Fixed to On.	2	Off	00	0	Not used. Fixed to Off.	3	Off	00	0	Not used. Fixed to Off.	4	On	10	16	Not used. Fixed to On.	5	Off	00	0	Not used. Fixed to Off.	6	Off	00	0	Not used. Fixed to Off.	7	Off	00	0	Not used. Fixed to Off.
Bit	On / Off	Hex	Decimal	Function																																																																																																																																																								
0	Off	00	0	Not used. Fixed to Off.																																																																																																																																																								
1	On	02	2	Not used. Fixed to On.																																																																																																																																																								
2	Off	00	0	Drawer open/close signal is LOW.																																																																																																																																																								
	On	04	4	Drawer open/close signal is HIGH.																																																																																																																																																								
3	Off	00	0	On-line.																																																																																																																																																								
	On	08	8	Off-line.																																																																																																																																																								
4	On	10	16	Not used. Fixed to On.																																																																																																																																																								
5	Off	00	0	Not used. Fixed to Off.																																																																																																																																																								
6	Off	00	0	Not used. Fixed to Off.																																																																																																																																																								
7	Off	00	0	Not used. Fixed to Off.																																																																																																																																																								
Bit	On / Off	Hex	Decimal	Function																																																																																																																																																								
0	Off	00	0	Not used. Fixed to Off.																																																																																																																																																								
1	On	02	2	Not used. Fixed to On.																																																																																																																																																								
2	Off	00	0	Cover is closed.																																																																																																																																																								
	On	04	4	Cover is open.																																																																																																																																																								
3	Off	00	0	Not used. Fixed to Off.																																																																																																																																																								
4	On	10	16	Not used. Fixed to On.																																																																																																																																																								
5	Off	00	0	No paper-end stop.																																																																																																																																																								
	On	20	32	Printing stops due to paper end.																																																																																																																																																								
6	Off	00	0	No error.																																																																																																																																																								
	On	40	64	Error occurs.																																																																																																																																																								
7	Off	00	0	Not used. Fixed to Off.																																																																																																																																																								
Bit	On / Off	Hex	Decimal	Function																																																																																																																																																								
0	Off	00	0	Not used. Fixed to Off.																																																																																																																																																								
1	On	02	2	Not used. Fixed to On.																																																																																																																																																								
2	Off	00	0	Not used. Fixed to Off.																																																																																																																																																								
3	Off	00	0	Not used. Fixed to Off.																																																																																																																																																								
4	On	10	16	Not used. Fixed to On.																																																																																																																																																								
5	Off	00	0	Not used. Fixed to Off.																																																																																																																																																								
6	Off	00	0	Not used. Fixed to Off.																																																																																																																																																								
7	Off	00	0	Not used. Fixed to Off.																																																																																																																																																								



Bit	On / Off	Hex	Decimal	Function
0	Off	00	0	Not used. Fixed to Off.
1	Off	02	2	Not used. Fixed to On.
2	Off	00	0	No paper-near-end stop.
	On	04	4	Printing stops due to paper near end.
3	Off	00	0	No paper-near-end stop.
	On	08	8	Printing stops due to paper near end.
4	On	10	16	Not used. Fixed to On.
5	Off	00	0	No paper-end stop.
	On	20	32	Printing stops due to paper end.
6	Off	00	0	No paper-end stop.
	On	40	64	Printing stops due to paper end.
7	Off	00	0	Not used. Fixed to Off.

### DLE ENQ n

[Name]	Real-time request to printer.
[Format]	ASCII DLE ENQ n Hex. 10 05 n Decimal 16 5 n
[Range]	$1 \leq n \leq 2$
[Description]	Responds to requests n specifications from the host in real-time. n specifications are below. n = 1: Recover from the error and start printing from the line where the error occurred. n = 2: Recover from error after clearing the reception buffer and print buffer. This command is enabled even when the printer specification is disabled by ESC = (select peripheral devices).

### DLE DC4 n m t

[Name]	Real-time output of specified pulse.
[Format]	ASCII DLE DC4 n m t Hex. 10 14 n m t Decimal 16 20 n m t
[Range]	n = 1 m = 0,1 $1 \leq t \leq 8$
[Description]	This outputs a signal specified by t to the connector pin specified by m. m = 0: #2 Pin of the drawer kick connector m = 1: #5 Pin of the drawer kick connector On time is set to t x 100 msec; Off time is set to t x 100 msec.

### ESC FF

[Name]	Print data in page mode.
[Format]	ASCII ESC FF Hex. 1B 0C Decimal 27 12
[Range]	N/A
[Description]	Prints all buffered data in the print area collectively in page mode. <ul style="list-style-type: none"> <li>● This command is enabled only in page mode.</li> <li>● Holds the following information after printing. <ol style="list-style-type: none"> <li>a. Expanded data</li> <li>b. Character print direction selection in page mode (ESC T)</li> <li>c. Set print region (ESC W) in the page mode.</li> <li>d. Character expansion position</li> </ol> </li> </ul>

### ESC SP n

[Name]	Set right-side character spacing.
[Format]	ASCII ESC SP n Hex. 1B 20 n Decimal 27 32 n
[Range]	0 ≤ n ≤ 255 Initial Value n = 0
[Description]	This command sets the size of space to right of character. Right space = n × [horizontal motion units].

### ESC ! n

[Name]	Select print mode(s).																																																																	
[Format]	ASCII ESC ! n Hex. 1B 21 n Decimal 27 33 n																																																																	
[Range]	0 ≤ n ≤ 255 Initial Value n = 0																																																																	
[Description]	This command selects print mode(s) with bits having following meanings. <table border="1" style="width: 100%; border-collapse: collapse;"> <thead> <tr> <th>Bit</th> <th>On / Off</th> <th>Hex</th> <th>Decimal</th> <th>Function</th> </tr> </thead> <tbody> <tr> <td rowspan="2">0</td> <td>Off</td> <td>00</td> <td>0</td> <td>Character font A selected.</td> </tr> <tr> <td>On</td> <td>01</td> <td>1</td> <td>Character font B selected.</td> </tr> <tr> <td>1</td> <td>Off</td> <td>00</td> <td>0</td> <td>Not used. Fixed to Off.</td> </tr> <tr> <td>2</td> <td>Off</td> <td>00</td> <td>0</td> <td>Not used. Fixed to Off.</td> </tr> <tr> <td rowspan="2">3</td> <td>Off</td> <td>00</td> <td>0</td> <td>Emphasized mode not selected.</td> </tr> <tr> <td>On</td> <td>08</td> <td>8</td> <td>Emphasized mode selected.</td> </tr> <tr> <td rowspan="2">4</td> <td>Off</td> <td>00</td> <td>0</td> <td>Double-height mode not selected</td> </tr> <tr> <td>On</td> <td>10</td> <td>16</td> <td>Double-height mode selected</td> </tr> <tr> <td rowspan="2">5</td> <td>Off</td> <td>00</td> <td>0</td> <td>Double-width mode not selected.</td> </tr> <tr> <td>On</td> <td>20</td> <td>32</td> <td>Double-width mode selected.</td> </tr> <tr> <td>6</td> <td>Off</td> <td>00</td> <td>0</td> <td>Not used. Fixed to Off.</td> </tr> <tr> <td rowspan="2">7</td> <td>Off</td> <td>00</td> <td>0</td> <td>Underline mode not selected.</td> </tr> <tr> <td>On</td> <td>80</td> <td>128</td> <td>Underline mode selected.</td> </tr> </tbody> </table>	Bit	On / Off	Hex	Decimal	Function	0	Off	00	0	Character font A selected.	On	01	1	Character font B selected.	1	Off	00	0	Not used. Fixed to Off.	2	Off	00	0	Not used. Fixed to Off.	3	Off	00	0	Emphasized mode not selected.	On	08	8	Emphasized mode selected.	4	Off	00	0	Double-height mode not selected	On	10	16	Double-height mode selected	5	Off	00	0	Double-width mode not selected.	On	20	32	Double-width mode selected.	6	Off	00	0	Not used. Fixed to Off.	7	Off	00	0	Underline mode not selected.	On	80	128	Underline mode selected.
Bit	On / Off	Hex	Decimal	Function																																																														
0	Off	00	0	Character font A selected.																																																														
	On	01	1	Character font B selected.																																																														
1	Off	00	0	Not used. Fixed to Off.																																																														
2	Off	00	0	Not used. Fixed to Off.																																																														
3	Off	00	0	Emphasized mode not selected.																																																														
	On	08	8	Emphasized mode selected.																																																														
4	Off	00	0	Double-height mode not selected																																																														
	On	10	16	Double-height mode selected																																																														
5	Off	00	0	Double-width mode not selected.																																																														
	On	20	32	Double-width mode selected.																																																														
6	Off	00	0	Not used. Fixed to Off.																																																														
7	Off	00	0	Underline mode not selected.																																																														
	On	80	128	Underline mode selected.																																																														

### ESC \$ nL nH

[Name]	Set absolute print position.
[Format]	ASCII ESC \$ nL nH Hex. 1B 24 nL nH Decimal 27 36 nL nH
[Range]	$0 \leq (nL + nH \times 256) \leq 65535$ ( $0 \leq nH \leq 255, 0 \leq nL \leq 255$ )
[Description]	This command specifies the next print starting position in reference to the left edge of the print area. The printing start position is calculated using $(nL + nH \times 256) \times$ (vertical or horizontal motion units). Specifications exceeding the print range are ignored.

### ESC \* m nL nH d1...dk

[Name]	Select bit image mode																														
[Format]	ASCII ESC * m nL nH d1...dk Hex. 1B 2A m nL nH d1...dk Decimal 27 42 m nL nH d1...dk																														
[Range]	$m = 0, 1, 32, 33$ $0 \leq nL \leq 255$ $0 \leq nH \leq 3$ $0 \leq d \leq 255$																														
[Description]	<p>Selects a bit-image mode in mode <math>m</math> for the number of dots specified by <math>nL</math> and <math>nH</math>.</p> <p><math>m = 1, 33</math> : <math>(nL+nH \times 256) &lt; 576</math> (3 inch); <math>(nL+nH \times 256) &lt; 432</math> (2 inch).  <math>m = 0, 32</math> : <math>(nL+nH \times 256) &lt; 288</math> (3 inch); <math>(nL+nH \times 256) &lt; 216</math> (2 inch).</p> <table border="1"> <thead> <tr> <th>m</th> <th>Mode</th> <th>Number of Vert. Dir. Dots</th> <th>Density of Vert. Dir. Dots</th> <th>Density of Hor. Dir. Dots</th> <th>Data Count (k)</th> </tr> </thead> <tbody> <tr> <td>0</td> <td>8 dot single density</td> <td>8</td> <td>67 DPI</td> <td>101 DPI</td> <td><math>nL+nH \times 256</math></td> </tr> <tr> <td>1</td> <td>8 dot double density</td> <td>8</td> <td>67 DPI</td> <td>203 DPI</td> <td><math>nL+nH \times 256</math></td> </tr> <tr> <td>32</td> <td>24 dot single density</td> <td>24</td> <td>203 DPI</td> <td>101 DPI</td> <td><math>(nL+nH \times 256) \times 3</math></td> </tr> <tr> <td>33</td> <td>24 dot double density</td> <td>24</td> <td>203 DPI</td> <td>203 DPI</td> <td><math>(nL+nH \times 256) \times 3</math></td> </tr> </tbody> </table>	m	Mode	Number of Vert. Dir. Dots	Density of Vert. Dir. Dots	Density of Hor. Dir. Dots	Data Count (k)	0	8 dot single density	8	67 DPI	101 DPI	$nL+nH \times 256$	1	8 dot double density	8	67 DPI	203 DPI	$nL+nH \times 256$	32	24 dot single density	24	203 DPI	101 DPI	$(nL+nH \times 256) \times 3$	33	24 dot double density	24	203 DPI	203 DPI	$(nL+nH \times 256) \times 3$
m	Mode	Number of Vert. Dir. Dots	Density of Vert. Dir. Dots	Density of Hor. Dir. Dots	Data Count (k)																										
0	8 dot single density	8	67 DPI	101 DPI	$nL+nH \times 256$																										
1	8 dot double density	8	67 DPI	203 DPI	$nL+nH \times 256$																										
32	24 dot single density	24	203 DPI	101 DPI	$(nL+nH \times 256) \times 3$																										
33	24 dot double density	24	203 DPI	203 DPI	$(nL+nH \times 256) \times 3$																										

### ESC - n

[Name]	Turn underline mode on/off.								
[Format]	ASCII ESC - n Hex. 1B 2D n Decimal 27 45 n								
[Range]	$0 \leq n \leq 2$ Initial Value $n = 0$								
[Description]	<p>This command enables the print data following it to be printer out underlined. The underline mode varied depending on the following values of n:</p> <table border="1"> <thead> <tr> <th>n</th> <th>Function</th> </tr> </thead> <tbody> <tr> <td>0</td> <td>Turns off underline mode</td> </tr> <tr> <td>1</td> <td>Turns on underline mode, set at 1-dot thick</td> </tr> <tr> <td>2</td> <td>Turns on underline mode, set at 2-dot thick</td> </tr> </tbody> </table>	n	Function	0	Turns off underline mode	1	Turns on underline mode, set at 1-dot thick	2	Turns on underline mode, set at 2-dot thick
n	Function								
0	Turns off underline mode								
1	Turns on underline mode, set at 1-dot thick								
2	Turns on underline mode, set at 2-dot thick								

### ESC 2

[Name]	Select default line spacing.
[Format]	ASCII ESC 2 Hex. 1B 32 Decimal 27 50
[Range]	N/A
[Descriptor]	This command sets the default line spacing The default line spacing is approximately 4.25 mm, which is equivalent to 34 dots.

### ESC 3 n

[Name]	Set line spacing.
[Format]	ASCII ESC 3 n Hex. 1B 33 n Decimal 27 51 n
[Range]	$0 \leq n \leq 255$ Initial Value n = 34
[Descriptor]	This command sets the line spacing using a following rule. Line spacing = n x (vertical or horizontal motion units)

### ESC = n

[Name]	Select peripheral device.																																				
[Format]	ASCII ESC = n Hex. 1B 3D n Decimal 27 61 n																																				
[Range]	$0 \leq n \leq 255$ Initial Value n = 1																																				
[Descriptor]	<p>Selects the peripheral device for which the data is effective from the host computer.</p> <table border="1" style="width: 100%; border-collapse: collapse;"> <thead> <tr> <th>Bit</th> <th>Function</th> <th>"0"</th> <th>"1"</th> </tr> </thead> <tbody> <tr><td>7</td><td>Undefined</td><td></td><td></td></tr> <tr><td>6</td><td>Undefined</td><td></td><td></td></tr> <tr><td>5</td><td>Undefined</td><td></td><td></td></tr> <tr><td>4</td><td>Undefined</td><td></td><td></td></tr> <tr><td>3</td><td>Undefined</td><td></td><td></td></tr> <tr><td>2</td><td>Undefined</td><td></td><td></td></tr> <tr><td>1</td><td>Undefined</td><td></td><td></td></tr> <tr><td>0</td><td>Printer</td><td>Invalid</td><td>Valid</td></tr> </tbody> </table>	Bit	Function	"0"	"1"	7	Undefined			6	Undefined			5	Undefined			4	Undefined			3	Undefined			2	Undefined			1	Undefined			0	Printer	Invalid	Valid
Bit	Function	"0"	"1"																																		
7	Undefined																																				
6	Undefined																																				
5	Undefined																																				
4	Undefined																																				
3	Undefined																																				
2	Undefined																																				
1	Undefined																																				
0	Printer	Invalid	Valid																																		

### ESC @

[Name]	Initialize printer.
[Format]	ASCII ESC @ Hex. 1B 40 Decimal 27 64
[Range]	N/A
[Descriptor]	Clears data from the print buffer and sets the printer to its default settings.

**ESC D n1...nk NUL**

[Name]	Set horizontal tab position
[Format]	ASCII ESC D n1...nk NUL Hex. 1B 44 n1...nk NUL Decimal 27 68 n1...nk NUL
[Range]	$1 \leq n \leq 255$ $0 \leq k \leq 32$
[Description]	Sets horizontal tab position <ul style="list-style-type: none"> <li>• n specifies the column number for setting a horizontal tab position from the left margin or the beginning of the line.</li> <li>• k indicates the number of horizontal tab positions to be set.</li> </ul>

**ESC E n**

[Name]	Turn emphasized mode on / off.
[Format]	ASCII ESC E n Hex. 1B 45 n Decimal 27 69 n
[Range]	$0 \leq n \leq 255$ Initial Value n = 0
[Description]	This command turns emphasized mode on or off by toggling the least significant bit of n like following. When the LSB of n is 0, emphasized mode is turned off. When the LSB of n is 1, emphasized mode is turned on.

**ESC G n**

[Name]	Turn double-strike mode on/off.
[Format]	ASCII ESC G n Hex. 1B 47 n Decimal 27 71 n
[Range]	$0 \leq n \leq 255$ Initial Value n = 0
[Description]	Specifies or cancels double printing. Cancels double printing when n = <*****0>B. Specifies double printing when n = <*****1>B. <ul style="list-style-type: none"> <li>• n is effective only when it is the lowest bit.</li> <li>• This printer is not capable of double printing, so the print is the same as when using emphasized printing.</li> <li>• This command is enabled for ANK characters</li> </ul>

**ESC J n**

[Name]	Print and feed paper.
[Format]	ASCII ESC J n Hex. 1B 4A n Decimal 27 74 n
[Range]	$0 \leq n \leq 255$
[Description]	This command prints the data in the print buffer and feeds the paper [n X vertical motion unit]. <ul style="list-style-type: none"> <li>• Sets the print position to the beginning of the next line after printing.</li> </ul>

	<ul style="list-style-type: none"> <li>● In standard mode, the printer uses the vertical motion unit (<i>y</i>).</li> <li>● In page mode, this command functions as follows, depending on the starting position of the printable area:             <ol style="list-style-type: none"> <li>(1) When the starting position is set to the upper left or lower right of the printable area using <b>ESC T</b>, the vertical motion unit (<i>y</i>) is used.</li> <li>(2) When the starting position is set to the upper right or lower left of the printable area using <b>ESC T</b>, the horizontal motion unit (<i>x</i>) is used.</li> </ol> </li> <li>● The maximum line spacing is 150mm {5.9 inches }. When the setting value exceeds the maximum, it is converted to the maximum automatically.</li> </ul>
--	---

## ESC L

[Name]	Select page mode
[Format]	ASCII ESC L Hex. 1B 4C Decimal 27 76
[Range]	N/A
[Description]	<ul style="list-style-type: none"> <li>● Enabled only when input with the top of line.</li> <li>● Invalid when input by page mode.</li> <li>● Returns to standard mode after the following commands are issued.             <ol style="list-style-type: none"> <li>a. FF (Print and recover to page mode)</li> <li>b. ESC S (Select standard mode)</li> </ol> </li> <li>● Character expansion position has the starting point specified by ESC T (Character print direction selection in page mode) in the printing region designated by the ESC W (Set print region in the page mode) command.</li> <li>● This command switches the settings for the following commands the values of which can be set independently in standard mode and page mode to those for page mode             <ol style="list-style-type: none"> <li>a. Set space amount: ESC SP, FS S</li> <li>b. Set line feed amount: ESC 2, ESC 3</li> </ol> </li> <li>● The following commands are enabled only when in page mode.             <ol style="list-style-type: none"> <li>a. ESC V :Specify/cancel character 90 degree clockwise rotation</li> <li>b. ESC a :Position alignment</li> <li>c. ESC { :Specify/cancel upside-down printing</li> <li>d. GS W :Set print region width</li> </ol> </li> <li>● The following command is ignored in page mode.             <ol style="list-style-type: none"> <li>a. GS (A :Test print</li> </ol> </li> <li>● The following commands are invalid in page mode.             <ol style="list-style-type: none"> <li>a. FS p :Print NV bit image</li> <li>b. FS q :Define NV bit image</li> <li>c. GS v 0 :Print raster bit images</li> <li>d. GS L :Set left margin</li> </ol> </li> <li>● Recover to standard mode using ESC @ (initialize printer).</li> </ul>

### ESC M n

[Name]	Select character font.						
[Format]	ASCII ESC M n Hex. 1B 4D n Decimal 27 77 n						
[Range]	n = 0, 1 Initial Value n = 0						
[Description]	<p>This command selects ANK character fonts using n as following.</p> <table border="1"> <thead> <tr> <th>n</th> <th>Function</th> </tr> </thead> <tbody> <tr> <td>0</td> <td>Character font A selected</td> </tr> <tr> <td>1</td> <td>Character font B selected</td> </tr> </tbody> </table>	n	Function	0	Character font A selected	1	Character font B selected
n	Function						
0	Character font A selected						
1	Character font B selected						

### ESC R n

[Name]	Select an international character set.																																				
[Format]	ASCII ESC R n Hex. 1B 52 n Decimal 27 82 n																																				
[Range]	0 ≤ n ≤ 16 Initial Value n = 0																																				
[Description]	<p>This command specifies international characters according to n values.</p> <table border="1"> <thead> <tr> <th>n</th> <th>Character set</th> </tr> </thead> <tbody> <tr> <td>0</td> <td>USA</td> </tr> <tr> <td>1</td> <td>France</td> </tr> <tr> <td>2</td> <td>Germany</td> </tr> <tr> <td>3</td> <td>UK</td> </tr> <tr> <td>4</td> <td>Denmark I</td> </tr> <tr> <td>5</td> <td>Sweden</td> </tr> <tr> <td>6</td> <td>Italy</td> </tr> <tr> <td>7</td> <td>Spain</td> </tr> <tr> <td>8</td> <td>Japan</td> </tr> <tr> <td>9</td> <td>Norway</td> </tr> <tr> <td>10</td> <td>Denmark II</td> </tr> <tr> <td>11</td> <td>Spain II</td> </tr> <tr> <td>12</td> <td>Latin America</td> </tr> <tr> <td>13</td> <td>Korea</td> </tr> <tr> <td>14</td> <td>Russia</td> </tr> <tr> <td>15</td> <td>Slavonic</td> </tr> <tr> <td>16</td> <td>User Define</td> </tr> </tbody> </table>	n	Character set	0	USA	1	France	2	Germany	3	UK	4	Denmark I	5	Sweden	6	Italy	7	Spain	8	Japan	9	Norway	10	Denmark II	11	Spain II	12	Latin America	13	Korea	14	Russia	15	Slavonic	16	User Define
n	Character set																																				
0	USA																																				
1	France																																				
2	Germany																																				
3	UK																																				
4	Denmark I																																				
5	Sweden																																				
6	Italy																																				
7	Spain																																				
8	Japan																																				
9	Norway																																				
10	Denmark II																																				
11	Spain II																																				
12	Latin America																																				
13	Korea																																				
14	Russia																																				
15	Slavonic																																				
16	User Define																																				

### ESC S

[Name]	Select standard mode
[Format]	ASCII ESC S Hex. 1B 53 Decimal 27 83
[Range]	N/A
[Description]	<ul style="list-style-type: none"> <li>● Valid only when input by page mode.</li> <li>● All buffer data in page mode is deleted.</li> <li>● Sets the print position to the beginning of the next line after execution.</li> <li>● The print area set by ESC W (Set print region in page mode) is reset to the default setting.</li> <li>● This command switches the settings for the following commands the values of which can be set independently in standard mode and page mode to those for standard mode             <ol style="list-style-type: none"> <li>a. ESC SP :Set character right space amount</li> <li>b. FS S :Set Chinese character space amount</li> <li>c. ESC 2 :Set default line spacing</li> <li>d. ESC 3 :Set line spacing</li> </ol> </li> <li>● The following commands are effective only when in standard mode.             <ol style="list-style-type: none"> <li>a. ESC W :Set print region in page mode</li> <li>b. ESC T :Select character print direction in page mode</li> </ol> </li> <li>● The following commands are ignored in standard mode.             <ol style="list-style-type: none"> <li>a. GS \$ :Specify absolute position for character vertical direction in page mode</li> <li>b. GS \ :Specify relative position for character vertical direction in page mode</li> </ol> </li> <li>● Standard mode is selected when the power is turned on, the printer is reset or initialized (ESC @).</li> </ul>

### ESC T n

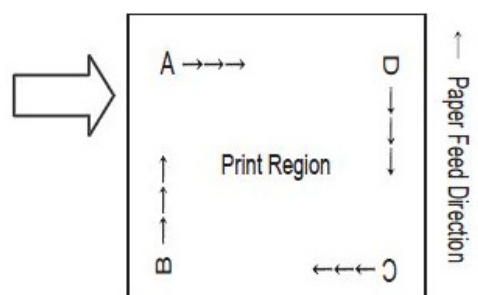
[Name]	Select print direction in page mode.															
[Format]	ASCII ESC T n Hex. 1B 54 n Decimal 27 84 n															
[Range]	$0 \leq n \leq 3, 48 \leq n \leq 51$ Initial Value n = 0															
[Description]	<p>Selects the character printing direction and starting point in page mode.</p> <table border="1" style="margin-left: 20px;"> <thead> <tr> <th>n</th> <th>Print Direction</th> <th>Starting Point</th> </tr> </thead> <tbody> <tr> <td>0, 48</td> <td>Left to Right</td> <td>Upper Left (A in the figure below)</td> </tr> <tr> <td>1, 49</td> <td>Bottom to Top</td> <td>Lower Left (B in the figure below)</td> </tr> <tr> <td>2, 50</td> <td>Right to Left</td> <td>Lower Right (C in the figure below)</td> </tr> <tr> <td>3, 51</td> <td>Top to Bottom</td> <td>Upper Right (D in the figure below)</td> </tr> </tbody> </table> 	n	Print Direction	Starting Point	0, 48	Left to Right	Upper Left (A in the figure below)	1, 49	Bottom to Top	Lower Left (B in the figure below)	2, 50	Right to Left	Lower Right (C in the figure below)	3, 51	Top to Bottom	Upper Right (D in the figure below)
n	Print Direction	Starting Point														
0, 48	Left to Right	Upper Left (A in the figure below)														
1, 49	Bottom to Top	Lower Left (B in the figure below)														
2, 50	Right to Left	Lower Right (C in the figure below)														
3, 51	Top to Bottom	Upper Right (D in the figure below)														



### ESC V n

[Name]	Turn 90 degree clockwise rotation mode on/off						
[Format]	ASCII ESC V n Hex. 1B 56 n Decimal 27 86 n						
[Range]	$0 \leq n \leq 1, 48 \leq n \leq 49$ Initial Value n = 0						
[Description]	<p>Specifies or cancels character 90 degree clockwise rotation.</p> <table border="1" style="margin-left: 20px;"> <thead> <tr> <th>n</th> <th>Function</th> </tr> </thead> <tbody> <tr> <td>0, 48</td> <td>Turns off 90 degree clockwise rotation mode</td> </tr> <tr> <td>1, 49</td> <td>Turns on 90 degree clockwise rotation mode</td> </tr> </tbody> </table> <ul style="list-style-type: none"> <li>● Underlines are not applied to characters rotated 90 degrees clockwise even when ESC !,ESC - or FS - commands are given.</li> <li>● If 90 degree clockwise rotation is specified, double-wide and double-tall commands in the 90 rotation mode enlarges characters in the opposite directions to double-wide and double-tall commands.</li> <li>● This command only affects printing in standard mode.</li> <li>● In page mode, this command is only effective for the setting.</li> <li>● This command is effective for ANK and Chinese characters.</li> </ul>	n	Function	0, 48	Turns off 90 degree clockwise rotation mode	1, 49	Turns on 90 degree clockwise rotation mode
n	Function						
0, 48	Turns off 90 degree clockwise rotation mode						
1, 49	Turns on 90 degree clockwise rotation mode						

### ESC W xL xH yL yH dxL dxH dyL dyH

[Name]	Set printing area in page mode
[Format]	ASCII ESC W xL xH yL yH dxL dxH dyL dyH Hex. 1B 57 xL xH yL yH dxL dxH dyL dyH Decimal 27 87 xL xH yL yH dxL dxH dyL dyH
[Range]	$0 \leq xL, xH, yL, yH, dxL, dxH, dyL, dyH \leq 255$ However, this excludes $dxL = dxH = 0$ or $dyL = dyH = 0$ Initial Value $xL = xH = yL = yH = 0$
[Description]	<p>Sets the print region position and size.</p> <ul style="list-style-type: none"> <li>● Horizontal direction starting point [(xL + xH x 256) x basic calculated pitch]</li> <li>● Vertical direction starting point [(yL + yH x 256) x basic calculated pitch]</li> <li>● Horizontal direction length [(dxL + dxH x 256) basic calculated pitch]</li> <li>● Vertical direction length = [(dyL + dyH x 256) basic calculated pitch]</li> <li>● <math>(X+Dx-1) &lt; 576</math> (3 inch, basic calculated pitch=1); <math>(X+Dx-1) &lt; 432</math> (2 inch, basic calculated pitch=1)</li> <li>● <math>(Y+Dy-1) &lt; 768</math> (basic calculated pitch=1);</li> <li>● If (horizontal starting position + printing area width) exceeds the printable area, the printing area width is automatically set to (horizontal printable area - horizontal starting position).</li> <li>● If (vertical starting position + printing area height) exceeds the printable area, the printing area height is automatically set to (vertical printable area - vertical starting position).</li> </ul> <div style="text-align: center; margin-top: 20px;"> </div>

### ESC \ nL nH

[Name]	Set relative print position.
[Format]	ASCII ESC \ nL nH Hex. 1B 5C nL nH Decimal 27 92 nL nH
[Range]	$0 \leq (nL + nH \times 256) \leq 65535$ ( $0 \leq nL \leq 255, 0 \leq nH \leq 255$ )
[Description]	Specifies the next print starting position with a relative position based on the current position. This sets the position from the current position to [(nL + nH x 256) x basic calculated pitch] for the next print starting position. <ul style="list-style-type: none"> <li>Specifications exceeding the print range are ignored..</li> </ul>

### ESC a n

[Name]	Select justification.								
[Format]	ASCII ESC a n Hex. 1B 61 n Decimal 27 97 n								
[Range]	$0 \leq n \leq 2$ Initial Value n = 0								
[Description]	This command specifies position alignment for all data in one line in standard mode, using n as follows: <table border="1" style="margin-left: auto; margin-right: auto;"> <thead> <tr> <th>n</th> <th>Alignment</th> </tr> </thead> <tbody> <tr> <td>0</td> <td>Left alignment</td> </tr> <tr> <td>1</td> <td>Center alignment</td> </tr> <tr> <td>2</td> <td>Right alignment</td> </tr> </tbody> </table> <p>This command has no effect in page mode.</p>	n	Alignment	0	Left alignment	1	Center alignment	2	Right alignment
n	Alignment								
0	Left alignment								
1	Center alignment								
2	Right alignment								

### ESC c 3 n

[Name]	Select paper sensor(s) to output paper-end signals.																																				
[Format]	ASCII ESC c 3 n Hex. 1B 63 33 n Decimal 27 99 51 n																																				
[Range]	Specification: $0 \leq n \leq 3$ Initial Value n = 0																																				
[Description]	Selects paper out detector that outputs a paper out signal when paper has run out. <table border="1" style="margin-left: auto; margin-right: auto;"> <thead> <tr> <th>Bit</th> <th>Function</th> <th>"0"</th> <th>"1"</th> </tr> </thead> <tbody> <tr> <td>7</td> <td>Undefined</td> <td></td> <td></td> </tr> <tr> <td>6</td> <td>Undefined</td> <td></td> <td></td> </tr> <tr> <td>5</td> <td>Undefined</td> <td></td> <td></td> </tr> <tr> <td>4</td> <td>Undefined</td> <td></td> <td></td> </tr> <tr> <td>3</td> <td>Undefined</td> <td></td> <td></td> </tr> <tr> <td>2</td> <td>Undefined</td> <td></td> <td></td> </tr> <tr> <td>1</td> <td>Paper roll near end detector</td> <td>Invalid</td> <td>Valid</td> </tr> <tr> <td>0</td> <td>Paper roll near end detector</td> <td>Invalid</td> <td>Valid</td> </tr> </tbody> </table>	Bit	Function	"0"	"1"	7	Undefined			6	Undefined			5	Undefined			4	Undefined			3	Undefined			2	Undefined			1	Paper roll near end detector	Invalid	Valid	0	Paper roll near end detector	Invalid	Valid
Bit	Function	"0"	"1"																																		
7	Undefined																																				
6	Undefined																																				
5	Undefined																																				
4	Undefined																																				
3	Undefined																																				
2	Undefined																																				
1	Paper roll near end detector	Invalid	Valid																																		
0	Paper roll near end detector	Invalid	Valid																																		

### ESC c 4 n

[Name]	Select paper sensor(s) to stop printing.																																						
[Format]	ASCII ESC c 4 n Hex. 1B 63 34 n Decimal 27 99 52 n																																						
[Range]	Specification: $0 \leq n \leq 3$ Initial Value n = 0																																						
[Description]	<p>Selects the paper out detector to stop printing when paper has run out.</p> <table border="1"> <thead> <tr> <th>Bit</th> <th>Function</th> <th>"0"</th> <th>"1"</th> </tr> </thead> <tbody> <tr> <td>7</td> <td>Undefined</td> <td></td> <td></td> </tr> <tr> <td>6</td> <td>Undefined</td> <td></td> <td></td> </tr> <tr> <td>5</td> <td>Undefined</td> <td></td> <td></td> </tr> <tr> <td>4</td> <td>Undefined</td> <td></td> <td></td> </tr> <tr> <td>3</td> <td>Undefined</td> <td></td> <td></td> </tr> <tr> <td>2</td> <td>Undefined</td> <td></td> <td></td> </tr> <tr> <td>1</td> <td>Paper roll near end detector</td> <td>Invalid</td> <td>Valid</td> </tr> <tr> <td>0</td> <td>Paper roll near end detector</td> <td>Invalid</td> <td>Valid</td> </tr> </tbody> </table>			Bit	Function	"0"	"1"	7	Undefined			6	Undefined			5	Undefined			4	Undefined			3	Undefined			2	Undefined			1	Paper roll near end detector	Invalid	Valid	0	Paper roll near end detector	Invalid	Valid
Bit	Function	"0"	"1"																																				
7	Undefined																																						
6	Undefined																																						
5	Undefined																																						
4	Undefined																																						
3	Undefined																																						
2	Undefined																																						
1	Paper roll near end detector	Invalid	Valid																																				
0	Paper roll near end detector	Invalid	Valid																																				

### ESC c 5 n

[Name]	Enable/disable panel buttons		
[Format]	ASCII ESC c 5 n Hex. 1B 63 35 n Decimal 27 99 53 n		
[Range]	Specification: $0 \leq n \leq 255$ Initial Value n = 0		
[Description]	<p>Toggles the panel switches between enabled and disabled.</p> <ul style="list-style-type: none"> <li>● Enables panel switches when n = &lt;*****0&gt;B.</li> <li>● Disables panel switches when n = &lt;*****1&gt;B.</li> <li>● n is effective only when it is the lowest bit.</li> <li>● When disabled, all panel switches are disabled.</li> </ul>		

### ESC d n

[Name]	Print and feed n lines		
[Format]	ASCII ESC d n Hex. 1B 64 n Decimal 27 100 n		
[Range]	$0 \leq n \leq 255$		
[Description]	<p>Prints the data in the print buffer and performs a paper feed of n lines.</p> <ul style="list-style-type: none"> <li>● Sets the print position to the beginning of the next line after printing.</li> <li>● Paper is fed approximately 150 mm if the [n x basic calculated pitch] exceeds approximately 150 mm (5.9 inches).</li> </ul>		

### ESC i

[Name]	Full cut.		
[Format]	ASCII ESC i Hex. 1B 69 Decimal 27 105		
[Range]	N/A		
[Description]	This command executes a full cut of the paper in standard mode		

### ESC m

[Name]	Partial cut.
[Format]	ASCII ESC m Hex. 1B 6D Decimal 27 109
[Range]	N/A
[Description]	This command executes a partial cut of the paper with one point uncut in standard mode.

### ESC p m t1 t2

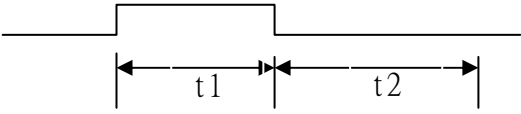
[Name]	General pulse.						
[Format]	ASCII ESC p m t1 t2 Hex. 1B 70 m t1 t2 Decimal 27 112 m t1 t2						
[Range]	$0 \leq m \leq 1$ , $48 \leq m \leq 49$ $0 \leq t1 \leq 255$ $0 \leq t2 \leq 255$						
[Description]	<p>This outputs a signal specified by t1 and t2 to the connector pin specified by m. Drawer kick on time is set to <math>t1 \times 2</math> ms; off time is set to <math>t2 \times 2</math> ms.</p> <table border="1" style="margin-left: 40px;"> <tr> <th>m</th> <th>Connector Pin</th> </tr> <tr> <td>0, 48</td> <td>Drawer kick connector pin #2</td> </tr> <tr> <td>1, 49</td> <td>Drawer kick connector pin #5</td> </tr> </table>  <p>The diagram shows a signal line that transitions from low to high for a duration of <math>t1</math>, then returns to low for a duration of <math>t2</math>, and then returns to high. Arrows indicate the time intervals <math>t1</math> and <math>t2</math>.</p>	m	Connector Pin	0, 48	Drawer kick connector pin #2	1, 49	Drawer kick connector pin #5
m	Connector Pin						
0, 48	Drawer kick connector pin #2						
1, 49	Drawer kick connector pin #5						

### ESC t n

[Name]	Select character code table.																				
[Format]	ASCII ESC t n Hex. 1B 74 n Decimal 27 116 n																				
[Range]	$0 \leq n \leq 8$ Initial Value $n = 0$																				
[Description]	<p>Select page n of the character code table.</p> <table border="1" style="margin-left: 40px;"> <tr> <th>n</th> <th>Character set</th> </tr> <tr> <td>0</td> <td>CP-437</td> </tr> <tr> <td>1</td> <td>Katakana</td> </tr> <tr> <td>2</td> <td>CP-850</td> </tr> <tr> <td>3</td> <td>CP-852</td> </tr> <tr> <td>4</td> <td>CP-860</td> </tr> <tr> <td>5</td> <td>CP-863</td> </tr> <tr> <td>6</td> <td>CP-865</td> </tr> <tr> <td>7</td> <td>CP-1252</td> </tr> <tr> <td>8</td> <td>User Define</td> </tr> </table>	n	Character set	0	CP-437	1	Katakana	2	CP-850	3	CP-852	4	CP-860	5	CP-863	6	CP-865	7	CP-1252	8	User Define
n	Character set																				
0	CP-437																				
1	Katakana																				
2	CP-850																				
3	CP-852																				
4	CP-860																				
5	CP-863																				
6	CP-865																				
7	CP-1252																				
8	User Define																				

### ESC { n

[Name]	Turns upside-down printing mode on/off.						
[Format]	ASCII ESC { n Hex. 1B 7B n Decimal 27 123 n						
[Range]	0 ≤ n ≤ 255 Initial Value n = 0						
[Description]	<p>Specifies or cancels upside-down printing.</p> <ul style="list-style-type: none"> <li>● Cancels upside-down printing when n = &lt;*****0&gt;H.</li> <li>● Specifies upside-down printing when n = &lt;*****1&gt;H.</li> <li>● n is effective only when it is the lowest bit.</li> <li>● This command is effective only when input at the top of the line when standard mode is being used.</li> <li>● This command has no affect in page mode. In page mode, this command is only effective for the setting.</li> <li>● Upside-down printing rotates line data 180 degrees.</li> </ul> <table border="1" style="margin-left: 40px;"> <tr> <td>n</td> <td>Upside-down mode</td> </tr> <tr> <td>0</td> <td>Turned off</td> </tr> <tr> <td>1</td> <td>Turned on</td> </tr> </table>	n	Upside-down mode	0	Turned off	1	Turned on
n	Upside-down mode						
0	Turned off						
1	Turned on						

### FS p n m

[Name]	Print NV bit image.										
[Format]	ASCII FS p n m Hex. 1C 70 n m Decimal 28 112 n m										
[Range]	1 ≤ n ≤ 255 0 ≤ m ≤ 3, 48 ≤ m ≤ 51										
[Description]	<p>Prints NV bit image n using mode m.</p> <table border="1" style="margin-left: 40px;"> <tr> <td>m</td> <td>Mode</td> </tr> <tr> <td>0, 48</td> <td>Normal</td> </tr> <tr> <td>1, 49</td> <td>Double-width</td> </tr> <tr> <td>2, 50</td> <td>Double-height</td> </tr> <tr> <td>3, 51</td> <td>Quadruple</td> </tr> </table> <ul style="list-style-type: none"> <li>● n specifies the NV bit image number.</li> <li>● m specifies the bit-image mode.</li> <li>● NV bit image is a bit image defined in non-volatile memory by FS q and printed by this command.</li> <li>● This command is ignored when the specified NV bit image n is undefined.</li> </ul>	m	Mode	0, 48	Normal	1, 49	Double-width	2, 50	Double-height	3, 51	Quadruple
m	Mode										
0, 48	Normal										
1, 49	Double-width										
2, 50	Double-height										
3, 51	Quadruple										

### FS q n [xL xH yL yH d1...dk]1...[xL xH yL yH d1...dk]n

[Name]	Define NV bit image.
[Format]	ASCII FS q n [xL xH yL yH d1...dk]1...[xL xH yL yH d1...dk]n Hex. 1C 71 n [xL xH yL yH d1...dk]1...[xL xH yL yH d1...dk]n Decimal 28 113 n [xL xH yL yH d1...dk]1...[xL xH yL yH d1...dk]n
[Range]	<p>1 ≤ n ≤ 255</p> <p>1 ≤ (xL + xH × 256) ≤ 54 (0 ≤ xL ≤ 54, xH=0) for 2 inch</p> <p>1 ≤ (xL + xH × 256) ≤ 72 (0 ≤ xL ≤ 72, xH=0) for 3 inch</p> <p>1 ≤ (yL + yH × 256) ≤ 96 (0 ≤ yL ≤ 96, yH=0)</p> <p>0 ≤ d ≤ 255</p> <p>k = (xL + xH × 256) × (yL + yH × 256) × 8</p>

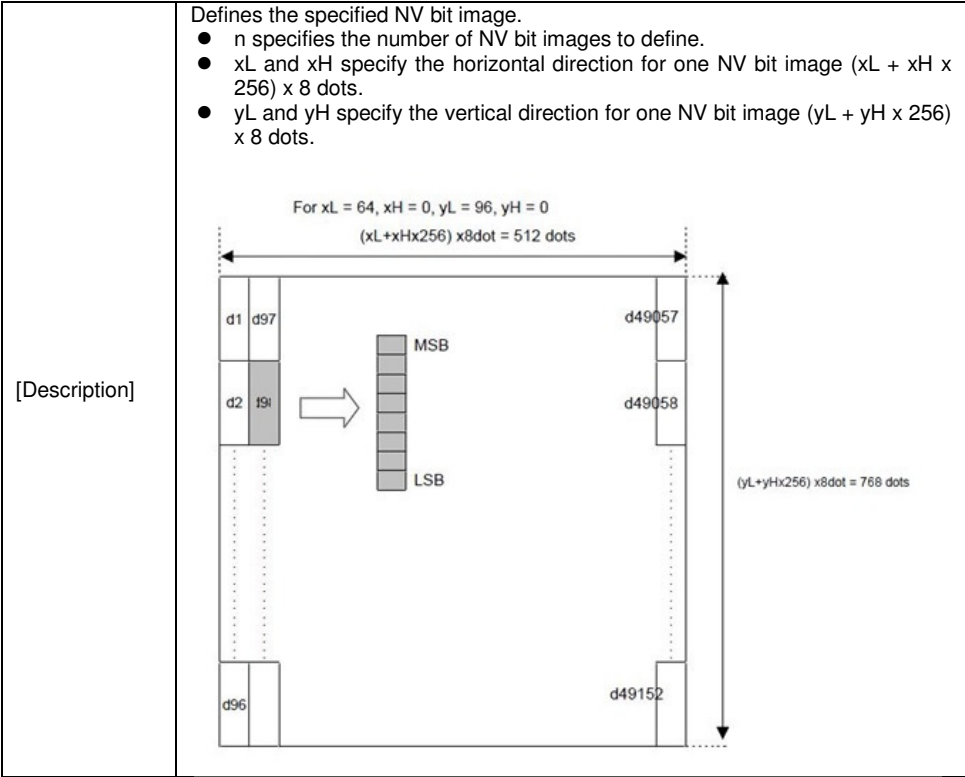

**GS ! n**

[Name]	Select character size.															
[Format]	ASCII GS ! n Hex. 1D 21 n Decimal 29 33 n															
[Range]	0 ≤ n ≤ 255 (1 ≤ Vertical enlargement ≤ 8, 1 ≤ Horizontal enlargement ≤ 8) Initial Value n = 0															
[Description]	<p>This command selects the character height and width using bits 0 to 3, and bits 4 to 7 respectively as follows:</p> <table border="1"> <thead> <tr> <th>Bit</th> <th>Function</th> <th>Setting</th> </tr> </thead> <tbody> <tr> <td>0</td> <td rowspan="4">Specifies the number of times normal font size in the vertical direction</td> <td rowspan="4">Refer to Table 2 [Enlarged in vertical direction]</td> </tr> <tr> <td>1</td> </tr> <tr> <td>2</td> </tr> <tr> <td>3</td> </tr> <tr> <td>4</td> <td rowspan="4">Specifies the number of times normal font size in the horizontal direction</td> <td rowspan="4">Refer to Table 1 [Enlarged in horizontal direction]</td> </tr> <tr> <td>5</td> </tr> <tr> <td>6</td> </tr> <tr> <td>7</td> </tr> </tbody> </table>	Bit	Function	Setting	0	Specifies the number of times normal font size in the vertical direction	Refer to Table 2 [Enlarged in vertical direction]	1	2	3	4	Specifies the number of times normal font size in the horizontal direction	Refer to Table 1 [Enlarged in horizontal direction]	5	6	7
Bit	Function	Setting														
0	Specifies the number of times normal font size in the vertical direction	Refer to Table 2 [Enlarged in vertical direction]														
1																
2																
3																
4	Specifies the number of times normal font size in the horizontal direction	Refer to Table 1 [Enlarged in horizontal direction]														
5																
6																
7																

Table 1 [Enlarged in horizontal direction]		
Hex	Decimal	Enlargement
00	0	1 time(standard)
10	16	2 times
20	32	3 times
30	48	4 times
40	64	5 times
50	80	6 times
60	96	7 times
70	112	8 times

Table 2 [Enlarged in vertical direction]		
Hex	Decimal	Enlargement
00	0	1 time(standard)
01	1	2 times
02	2	3 times
03	3	4 times
04	4	5 times
05	5	6 times
06	6	7 times
07	7	8 times

### GS \$ nL nH

[Name]	Set absolute vertical print position in page mode
[Format]	ASCII GS \$ nL nH Hex. 1D 24 nL nH Decimal 29 36 nL nH
[Range]	0 ≤ nL ≤ 255, 0 ≤ nH ≤ 255,
[Description]	<p>Specifies the character vertical direction position for the data expansion starting position using the absolute position based on the starting point in page mode. The position of the character vertical direction for the next data expansion starting position is the position specified by [(nL + nH x 256) x basic calculated pitch] from the starting point.</p> <ul style="list-style-type: none"> <li>● When not in page mode, this command is ignored.</li> <li>● Specifications for absolute positions that exceed the specified print range are ignored.</li> </ul>

### GS \* X Y [d1...d(X x Y x 8)]

[Name]	Define download bit images.
[Format]	ASCII GS * X Y [d1...d(X x Y x 8)] Hex. 1D 2A X Y [d1...d(X x Y x 8)] Decimal 29 42 X Y [d1...d(X x Y x 8)]
[Range]	1 ≤ X ≤ 54 (for 2 inch) 1 ≤ X ≤ 72 (for 3 inch) 1 ≤ Y ≤ 96 0 ≤ d ≤ 255

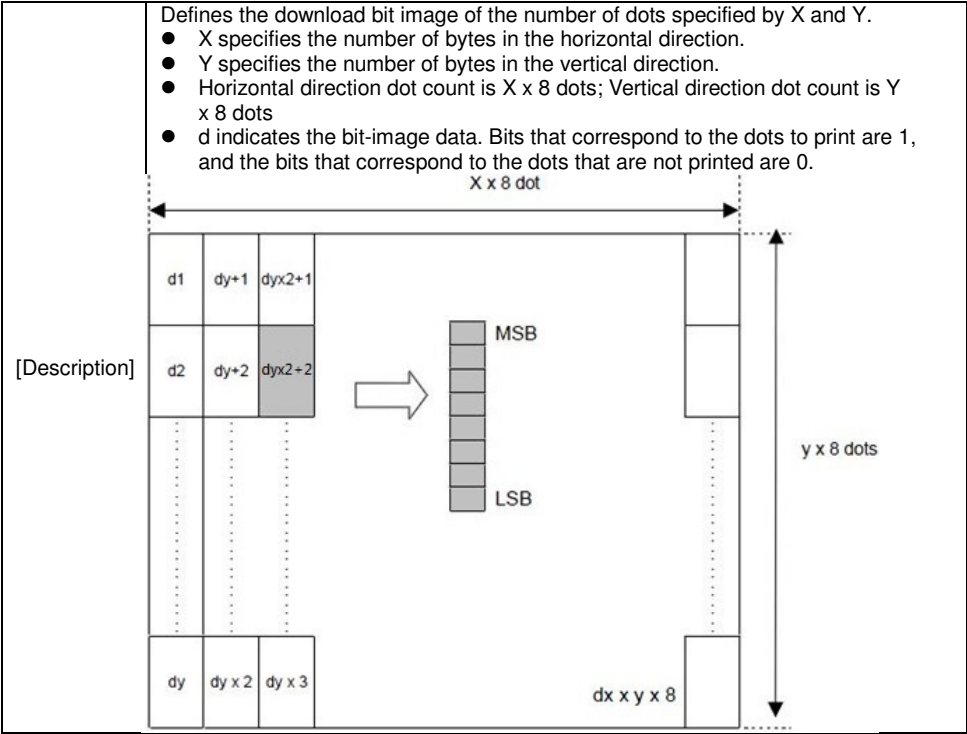

**GS ( A pL pH n m**

[Name]	Execute test print.														
[Format]	ASCII GS ( A pL pH n m Hex. 1D 28 41 pL pH n m Decimal 29 40 65 pL pH n m														
[Range]	$\{pL + (pH \times 256)\} = 2$ ( $pL = 2, pH = 0$ ) $0 \leq n \leq 2, 48 \leq n \leq 50$ $2 \leq m \leq 3, 50 \leq m \leq 51$														
[Description]	<p>Executes the specified test print. The following command is ignored in page mode.</p> <p>Specifies the parameter count following pL and pH in <math>(pL + (pH \times 256))</math> bytes. <i>n</i> specifies the paper to be tested.</p> <table border="1"> <tr> <td>n</td> <td>Paper Type</td> </tr> <tr> <td>0, 48</td> <td>Basic sheet (paper roll)</td> </tr> <tr> <td>1, 49</td> <td>Paper Roll</td> </tr> <tr> <td>2, 50</td> <td></td> </tr> </table> <p><i>m</i> specifies a test pattern..</p> <table border="1"> <tr> <td>m</td> <td>Type of Test Print</td> </tr> <tr> <td>2, 50</td> <td>Printer Status (Self Print)</td> </tr> <tr> <td>3, 51</td> <td>Rolling Pattern Print</td> </tr> </table>	n	Paper Type	0, 48	Basic sheet (paper roll)	1, 49	Paper Roll	2, 50		m	Type of Test Print	2, 50	Printer Status (Self Print)	3, 51	Rolling Pattern Print
n	Paper Type														
0, 48	Basic sheet (paper roll)														
1, 49	Paper Roll														
2, 50															
m	Type of Test Print														
2, 50	Printer Status (Self Print)														
3, 51	Rolling Pattern Print														



### GS ( K pL pH n m

[Name]	Set print density.																												
[Format]	ASCII GS ( A pL pH n m Hex. 1D 28 4B pL pH n m Decimal 29 40 75 pL pH n m																												
[Range]	{pL+ (pH×256) } = 2 (pL = 2,pH = 0) n = 49 250 ≤ m ≤ 255, 0 ≤ m ≤ 6 Initial Value m = 0																												
[Description]	<p>Sets print density..</p> <table border="1"> <thead> <tr> <th>m</th> <th>Print Density</th> </tr> </thead> <tbody> <tr><td>250</td><td>0.7</td></tr> <tr><td>251</td><td>0.7</td></tr> <tr><td>252</td><td>0.8</td></tr> <tr><td>253</td><td>0.8</td></tr> <tr><td>254</td><td>0.9</td></tr> <tr><td>255</td><td>0.9</td></tr> <tr><td>0</td><td>1.0</td></tr> <tr><td>1</td><td>1.1</td></tr> <tr><td>2</td><td>1.1</td></tr> <tr><td>3</td><td>1.2</td></tr> <tr><td>4</td><td>1.2</td></tr> <tr><td>5</td><td>1.3</td></tr> <tr><td>6</td><td>1.3</td></tr> </tbody> </table>	m	Print Density	250	0.7	251	0.7	252	0.8	253	0.8	254	0.9	255	0.9	0	1.0	1	1.1	2	1.1	3	1.2	4	1.2	5	1.3	6	1.3
m	Print Density																												
250	0.7																												
251	0.7																												
252	0.8																												
253	0.8																												
254	0.9																												
255	0.9																												
0	1.0																												
1	1.1																												
2	1.1																												
3	1.2																												
4	1.2																												
5	1.3																												
6	1.3																												

### GS / m

[Name]	Print downloaded bit image.																				
[Format]	ASCII GS / m Hex. 1D 2F m Decimal 29 47 m																				
[Range]	0 ≤ m ≤ 3, 48 ≤ m ≤ 51																				
[Description]	<p>This command prints the downloaded bit image defined by GS * according to the mode denoted by m.</p> <table border="1"> <thead> <tr> <th>m</th> <th>Mode</th> <th>Vertical dot density(DPI)</th> <th>Horizontal dot density(DPI)</th> </tr> </thead> <tbody> <tr><td>0 , 48</td><td>Normal</td><td>203</td><td>203</td></tr> <tr><td>1 , 49</td><td>Double-width</td><td>203</td><td>101</td></tr> <tr><td>2 , 50</td><td>Double-height</td><td>101</td><td>203</td></tr> <tr><td>3 , 51</td><td>Quadruple</td><td>101</td><td>101</td></tr> </tbody> </table>	m	Mode	Vertical dot density(DPI)	Horizontal dot density(DPI)	0 , 48	Normal	203	203	1 , 49	Double-width	203	101	2 , 50	Double-height	101	203	3 , 51	Quadruple	101	101
m	Mode	Vertical dot density(DPI)	Horizontal dot density(DPI)																		
0 , 48	Normal	203	203																		
1 , 49	Double-width	203	101																		
2 , 50	Double-height	101	203																		
3 , 51	Quadruple	101	101																		

### GS B n

[Name]	Turn white/black reverse printing mode on/off
[Format]	ASCII GS B n Hex. 1D 42 n Decimal 29 66 n
[Range]	$0 \leq n \leq 255$ Initial Value n = 0
[Description]	<p>Specifies or cancels black and white inverted printing.</p> <ul style="list-style-type: none"> <li>● Cancels black and white inverted printing when <math>n = &lt;*****0&gt;B</math>.</li> <li>● Specifies black and white inverted printing when <math>n = &lt;*****1&gt;B</math>.</li> <li>● n is effective only when it is the lowest bit.</li> <li>● Internal characters and download characters are targeted for black and white inverted printing.</li> <li>● This command is effective for ANK and Chinese characters.</li> </ul>

### GS H n

[Name]	Select printing position of HRI characters.										
[Format]	ASCII GS H n Hex. 1D 48 n Decimal 29 72 n										
[Range]	$0 \leq n \leq 3, 48 \leq n \leq 51$ Initial Value n = 0										
[Description]	<p>Selects the printing position of HRI characters when printing bar codes.</p> <table border="1"> <thead> <tr> <th>m</th> <th>Printing Position</th> </tr> </thead> <tbody> <tr> <td>0, 48</td> <td>No print</td> </tr> <tr> <td>1, 49</td> <td>Above bar code</td> </tr> <tr> <td>2, 50</td> <td>Below bar code</td> </tr> <tr> <td>3, 51</td> <td>Above and below bar code(both)</td> </tr> </tbody> </table>	m	Printing Position	0, 48	No print	1, 49	Above bar code	2, 50	Below bar code	3, 51	Above and below bar code(both)
m	Printing Position										
0, 48	No print										
1, 49	Above bar code										
2, 50	Below bar code										
3, 51	Above and below bar code(both)										

### GS I n

[Name]	Transmit printer ID.																											
[Format]	ASCII GS I n Hex. 1D 49 n Decimal 29 73 n																											
[Range]	$1 \leq n \leq 3, 49 \leq n \leq 51, 65 \leq n \leq 69$																											
[Description]	<p>Transmits the printer ID specified by n as follows:</p> <table border="1"> <thead> <tr> <th>n</th> <th>Printer ID Type</th> <th>Specifications</th> </tr> </thead> <tbody> <tr> <td>1, 49</td> <td>Model ID</td> <td>MB-1030 or MP-1060</td> </tr> <tr> <td>2, 50</td> <td>Type ID</td> <td>1030-XX or 1060-XX</td> </tr> <tr> <td>3, 51</td> <td>ROM Version ID</td> <td>Depends on the ROM version</td> </tr> <tr> <td>65</td> <td>Firmware Version</td> <td>Depends on the firmware version</td> </tr> <tr> <td>66</td> <td>Manufacturer Name</td> <td>MB-1030 System or MP-1060 System</td> </tr> <tr> <td>67</td> <td>Model Name</td> <td>MB-1030 or MP-1060</td> </tr> <tr> <td>68</td> <td>Serial Number</td> <td>Depends on the serial number</td> </tr> <tr> <td>69</td> <td>Chinese Character Types</td> <td> <u>Taiwan Language Characters: TW_BIG5</u>  <u>Japanese Language Characters: JP_SJIS</u>  <u>Chinese Language Characters: CN_GB2312</u>  <u>Korean Language Characters: KO_EUC-KR</u> </td> </tr> </tbody> </table>	n	Printer ID Type	Specifications	1, 49	Model ID	MB-1030 or MP-1060	2, 50	Type ID	1030-XX or 1060-XX	3, 51	ROM Version ID	Depends on the ROM version	65	Firmware Version	Depends on the firmware version	66	Manufacturer Name	MB-1030 System or MP-1060 System	67	Model Name	MB-1030 or MP-1060	68	Serial Number	Depends on the serial number	69	Chinese Character Types	<u>Taiwan Language Characters: TW_BIG5</u> <u>Japanese Language Characters: JP_SJIS</u> <u>Chinese Language Characters: CN_GB2312</u> <u>Korean Language Characters: KO_EUC-KR</u>
n	Printer ID Type	Specifications																										
1, 49	Model ID	MB-1030 or MP-1060																										
2, 50	Type ID	1030-XX or 1060-XX																										
3, 51	ROM Version ID	Depends on the ROM version																										
65	Firmware Version	Depends on the firmware version																										
66	Manufacturer Name	MB-1030 System or MP-1060 System																										
67	Model Name	MB-1030 or MP-1060																										
68	Serial Number	Depends on the serial number																										
69	Chinese Character Types	<u>Taiwan Language Characters: TW_BIG5</u> <u>Japanese Language Characters: JP_SJIS</u> <u>Chinese Language Characters: CN_GB2312</u> <u>Korean Language Characters: KO_EUC-KR</u>																										

**GS L nL nH**

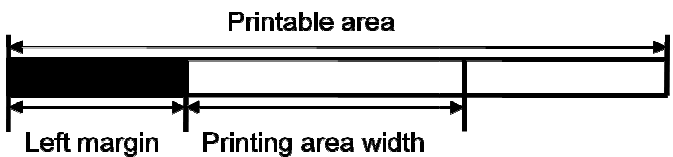
[Name]	Set left margin.
[Format]	ASCII GS L nL nH Hex. 1D 4C nL nH Decimal 29 76 nL nH
[Range]	$0 \leq nL \leq 255$ , $0 \leq nH \leq 255$ Initial Value (nL + nH x 256)=0 (nL=0, nH=0)
[Description]	nL and nH set the specified left margin. The left margin is [(nL + nH x 256) x basic calculated pitch].  The diagram illustrates the page layout. A horizontal line represents the page width. From the left, a shaded rectangular area is labeled 'Left margin'. To its right, a double-headed arrow indicates the 'Printing area width'. The entire area from the left edge to the right edge of the printing area width is labeled 'Printable area' with a double-headed arrow above it.

**GS P x y**

[Name]	Set basic calculated pitch.
[Format]	ASCII GS P x y Hex. 1D 50 x y Decimal 29 80 x y
[Range]	$0 \leq x \leq 255$ $0 \leq y \leq 255$ Initial Value x = 203, y = 203: EPSON targeted model print head 203 DPI
[Description]	Sets the horizontal basic calculated pitch to approximately 25.4/xmm [(1/x) inch], and the vertical basic calculated pitch to approximately 25.4/ymm [(1/y) inch]. x = 0: Returns the horizontal basic calculated pitch to its default value. y = 0: Returns the vertical basic calculated pitch to its default value.

**GS V m**

[Name]	Cut paper.										
[Format]	ASCII GS V m (n) Hex. 1D 56 m (n) Decimal 29 86 m (n)										
[Range]	m = 0,1,48,49,65,66 $0 \leq n \leq 255$										
[Description]	Executes specified paper cut. <table border="1" data-bbox="308 1215 1071 1406"> <thead> <tr> <th>m</th> <th>Function</th> </tr> </thead> <tbody> <tr> <td>0, 48</td> <td>Full cut</td> </tr> <tr> <td>1, 49</td> <td>Partial cut (one point uncut)</td> </tr> <tr> <td>65</td> <td>Feeds paper to (cutting position + [n x basic calculated pitch]) and performs a full cut</td> </tr> <tr> <td>66</td> <td>Feeds paper to (cutting position + [n x basic calculated pitch]) and performs a partial cut (one point uncut)</td> </tr> </tbody> </table>	m	Function	0, 48	Full cut	1, 49	Partial cut (one point uncut)	65	Feeds paper to (cutting position + [n x basic calculated pitch]) and performs a full cut	66	Feeds paper to (cutting position + [n x basic calculated pitch]) and performs a partial cut (one point uncut)
m	Function										
0, 48	Full cut										
1, 49	Partial cut (one point uncut)										
65	Feeds paper to (cutting position + [n x basic calculated pitch]) and performs a full cut										
66	Feeds paper to (cutting position + [n x basic calculated pitch]) and performs a partial cut (one point uncut)										

### GS W nL nH

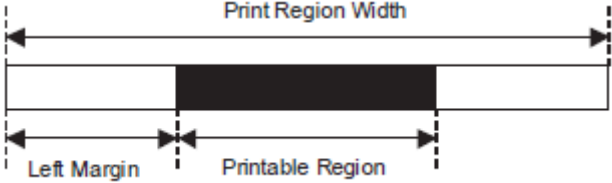
[Name]	Set printing area width.
[Format]	ASCII GS W nL nH Hex. 1D 57 nL nH Decimal 29 87 nL nH
[Range]	$0 \leq nL \leq 255, 0 \leq nH \leq 255$
[Description]	<ul style="list-style-type: none"> <li>• Sets the print region width specified by nL and nH.</li> <li>• Print region width is [(nL + nH x 256) x basic calculated pitch].</li> <li>• [(nL + nH x 256) x basic calculated pitch] &gt;=24.</li> </ul> 

### GS \ nL nH

[Name]	Set relative vertical print position in page mode.
[Format]	ASCII GS \ nL nH Hex. 1D 5C nL nH Decimal 29 92 nL nH
[Range]	$0 \leq nL \leq 255$ $0 \leq nH \leq 255$
[Description]	<p>Specifies the character vertical direction position for the data expansion starting position using the relative position based on the current point in page mode. This sets the position moved from the current position to [(nL + nH x 256) x basic calculated pitch] for the next data expanding starting position.</p> <ul style="list-style-type: none"> <li>• When not in page mode, this command is ignored.</li> </ul>

### GS a n

[Name]	Enable/disable Automatic Status Back (ASB).																																				
[Format]	ASCII GS a n Hex. 1D 61 n Decimal 29 97 n																																				
[Range]	$0 \leq n \leq 255$ Initial Value n = 0																																				
[Description]	<p>Selects the statuses that are targeted for transmission with the automatic status function (ASB: Automatic Status Back).</p> <table border="1" data-bbox="320 1258 960 1492"> <thead> <tr> <th>Bits</th> <th>Statuses Targeted for ASB</th> <th>"0"</th> <th>"1"</th> </tr> </thead> <tbody> <tr> <td>7</td> <td>Undefined</td> <td>---</td> <td>---</td> </tr> <tr> <td>6</td> <td>Undefined</td> <td>---</td> <td>---</td> </tr> <tr> <td>5</td> <td>Undefined</td> <td>---</td> <td>---</td> </tr> <tr> <td>4</td> <td>Undefined</td> <td>---</td> <td>---</td> </tr> <tr> <td>3</td> <td>Continuous Paper Detector</td> <td>Invalid</td> <td>Valid</td> </tr> <tr> <td>2</td> <td>Error</td> <td>Invalid</td> <td>Valid</td> </tr> <tr> <td>1</td> <td>ONLINE/OFFLINE Status</td> <td>Invalid</td> <td>Valid</td> </tr> <tr> <td>0</td> <td>Drawer kick connector pin #3</td> <td>Invalid</td> <td>Valid</td> </tr> </tbody> </table>	Bits	Statuses Targeted for ASB	"0"	"1"	7	Undefined	---	---	6	Undefined	---	---	5	Undefined	---	---	4	Undefined	---	---	3	Continuous Paper Detector	Invalid	Valid	2	Error	Invalid	Valid	1	ONLINE/OFFLINE Status	Invalid	Valid	0	Drawer kick connector pin #3	Invalid	Valid
Bits	Statuses Targeted for ASB	"0"	"1"																																		
7	Undefined	---	---																																		
6	Undefined	---	---																																		
5	Undefined	---	---																																		
4	Undefined	---	---																																		
3	Continuous Paper Detector	Invalid	Valid																																		
2	Error	Invalid	Valid																																		
1	ONLINE/OFFLINE Status	Invalid	Valid																																		
0	Drawer kick connector pin #3	Invalid	Valid																																		

The printer information transmitted is comprised of 4 bytes as follows:  
First byte(printer information)

Bit	Off/On	Hex	Decimal	Function
7	Off	00	0	Not used. Fixed to Off
6	Off	00	0	Paper is not being fed by the paper feed button
	On	40	64	Paper is being fed by the paper feed button
5	Off	00	0	Cover is close
	On	20	32	Cover is open
4	On	10	16	Not used. Fixed to On
3	Off	00	0	On-line
	On	08	8	Off-line
2	Off	00	0	Drawer kick-out connector pin 3 is LOW
	On	04	4	Drawer kick-out connector pin 3 is HIGH
1	Off	00	0	Not used. Fixed to Off
0	Off	00	0	Not used. Fixed to Off

Second byte(printer information)

Bit	Off/On	Hex	Decimal	Function
7	Off	00	0	Not used. Fixed to Off
6	Off	00	0	Not used. Fixed to Off
5	Off	00	0	Not used. Fixed to Off
4	Off	00	0	Not used. Fixed to Off
3	On	08	8	Not used. Fixed to Off
2	On	04	4	Not used. Fixed to Off
1	On	02	2	Not used. Fixed to Off
0	On	01	1	Not used. Fixed to Off

Third byte (paper sensor information)

Bit	Off/On	Hex	Decimal	Function
7	Off	00	0	Not used. Fixed to Off
6	Off	00	0	Not used. Fixed to Off
5	Off	00	0	Not used. Fixed to Off
4	On	00	0	Not used. Fixed to Off
2,3	Off	00	0	Paper end sensor: paper present
	On	0C	12	Paper end sensor: no paper present
0,1	Off	00	0	Paper near end sensor: paper adequate
	On	03	3	Paper near end sensor: paper near end

Fourth byte (paper sensor information)

Bit	Off/On	Hex	Decimal	Function
7	Off	00	0	Not used. Fixed to Off
6	Off	00	0	Black mark sensor status
5	Off	00	0	Not used. Fixed to Off
4	Off	00	0	Not used. Fixed to Off
3	On	08	8	Not used. Fixed to On
2	On	04	4	Not used. Fixed to On
1	On	02	2	Not used. Fixed to On
0	On	01	1	Not used. Fixed to On

### GS f n

[Name]	Select font for HRI characters.						
[Format]	ASCII GS f n Hex. 1D 66 n Decimal 29 102 n						
[Range]	n = 0,1,48,49 Initial Value n = 0						
[Description]	Selects the HRI character font when printing bar codes. <table border="1" style="width: 100%;"> <tr> <td>n</td> <td>Font</td> </tr> <tr> <td>0, 48</td> <td>Selects Font A (12 x 24).</td> </tr> <tr> <td>1, 49</td> <td>Selects Font B (9 x 17).</td> </tr> </table>	n	Font	0, 48	Selects Font A (12 x 24).	1, 49	Selects Font B (9 x 17).
n	Font						
0, 48	Selects Font A (12 x 24).						
1, 49	Selects Font B (9 x 17).						

### GS h n

[Name]	Set bar code height.
[Format]	ASCII GS h n Hex. 1D 68 n Decimal 29 104 n
[Range]	$1 \leq n \leq 255$ Initial Value n = 162
[Description]	Sets bar code height to n dots.

### GS k m d1 ... dk NUL.

### GS k m n d1 ... dk

[Name]	Print bar code.																																
[Format]	1. ASCII GS k m d1...dk NUL Hex. 1D 6B m d1...dk NUL Decimal 29 107 m d1...dk NUL 2. ASCII GS k m n d1...dk Hex. 1D 6B m n d1...dk Decimal 29 107 m n d1...dk																																
[Range]	1. $0 \leq m \leq 6$ The definition region of k and d differ according to the bar code type. 2. $65 \leq m \leq 73$ The definition region of n and d differ according to the bar code type																																
[Description]	Selects bar code type and prints bar codes. 1: <table border="1" style="width: 100%;"> <thead> <tr> <th>m</th> <th>Bar Code Type</th> <th>Defined region of k</th> <th>Defined region of d</th> </tr> </thead> <tbody> <tr> <td>0</td> <td>UPC-A</td> <td><math>11 \leq k \leq 12</math></td> <td><math>48 \leq d \leq 57</math></td> </tr> <tr> <td>1</td> <td>UPC-E</td> <td><math>11 \leq k \leq 12</math></td> <td><math>48 \leq d \leq 57</math></td> </tr> <tr> <td>2</td> <td>JAN13 (EAN13)</td> <td><math>12 \leq k \leq 13</math></td> <td><math>48 \leq d \leq 57</math></td> </tr> <tr> <td>3</td> <td>JAN8 (EAN8)</td> <td><math>7 \leq k \leq 8</math></td> <td><math>48 \leq d \leq 57</math></td> </tr> <tr> <td>4</td> <td>CODE39</td> <td><math>1 \leq k \leq 255</math></td> <td><math>48 \leq d \leq 57, 65 \leq d \leq 90, 32, 36, 37, 43, 45, 46, 47</math></td> </tr> <tr> <td>5</td> <td>ITF</td> <td><math>2 \leq k \leq 254</math> (However, This is an even number.)</td> <td><math>48 \leq d \leq 57</math></td> </tr> <tr> <td>6</td> <td>CODABAR</td> <td><math>1 \leq k \leq 255</math></td> <td><math>48 \leq d \leq 57, 65 \leq d \leq 68, 36, 43, 45, 46, 47, 58</math></td> </tr> </tbody> </table>	m	Bar Code Type	Defined region of k	Defined region of d	0	UPC-A	$11 \leq k \leq 12$	$48 \leq d \leq 57$	1	UPC-E	$11 \leq k \leq 12$	$48 \leq d \leq 57$	2	JAN13 (EAN13)	$12 \leq k \leq 13$	$48 \leq d \leq 57$	3	JAN8 (EAN8)	$7 \leq k \leq 8$	$48 \leq d \leq 57$	4	CODE39	$1 \leq k \leq 255$	$48 \leq d \leq 57, 65 \leq d \leq 90, 32, 36, 37, 43, 45, 46, 47$	5	ITF	$2 \leq k \leq 254$ (However, This is an even number.)	$48 \leq d \leq 57$	6	CODABAR	$1 \leq k \leq 255$	$48 \leq d \leq 57, 65 \leq d \leq 68, 36, 43, 45, 46, 47, 58$
m	Bar Code Type	Defined region of k	Defined region of d																														
0	UPC-A	$11 \leq k \leq 12$	$48 \leq d \leq 57$																														
1	UPC-E	$11 \leq k \leq 12$	$48 \leq d \leq 57$																														
2	JAN13 (EAN13)	$12 \leq k \leq 13$	$48 \leq d \leq 57$																														
3	JAN8 (EAN8)	$7 \leq k \leq 8$	$48 \leq d \leq 57$																														
4	CODE39	$1 \leq k \leq 255$	$48 \leq d \leq 57, 65 \leq d \leq 90, 32, 36, 37, 43, 45, 46, 47$																														
5	ITF	$2 \leq k \leq 254$ (However, This is an even number.)	$48 \leq d \leq 57$																														
6	CODABAR	$1 \leq k \leq 255$	$48 \leq d \leq 57, 65 \leq d \leq 68, 36, 43, 45, 46, 47, 58$																														

2:			
m	Bar Code Type	Defined region of n	Defined region of d
65	UPC-A	$11 \leq n \leq 12$	$48 \leq d \leq 57$
66	UPC-E	$11 \leq n \leq 12$	$48 \leq d \leq 57$
67	JAN13 (EAN13)	$12 \leq n \leq 13$	$48 \leq d \leq 57$
68	JAN8 (EAN8)	$7 \leq n \leq 8$	$48 \leq d \leq 57$
69	CODE39	$1 \leq n \leq 255$	$48 \leq d \leq 57, 65 \leq d \leq 90, 32, 36, 37, 43, 45, 46, 47$
70	ITF	$2 \leq n \leq 254$ (However, this is an even number.)	$48 \leq d \leq 57$
71	CODABAR	$1 \leq n \leq 255$	$48 \leq d \leq 57, 65 \leq d \leq 68, 36, 43, 45, 46, 47, 58$
72	CODE93	$1 \leq n \leq 255$	$0 \leq d \leq 127$
73	CODE128	$2 \leq n \leq 255$	$0 \leq d \leq 127$

### GS r n

[Name]	Transmit status.			
[Format]	ASCII GS r n Hex. 1D 72 n Decimal 29 114 n			
[Range]	n = 1, 2, 49, 50			
[Description]	Sends the specified status. Detector Status (n=1,49)			
	Bit	Status	"0"	
	7	Fixed at 0		
	6	Undefined		
	5	Undefined		
	4	Fixed at 0		
	3	Paper roll end detector	Has Paper	Paper out
	2	Paper roll end detector	Has Paper	Paper out
	1	Paper roll near end detector	Has Paper	Paper out
	0	Paper roll near end detector	Has Paper	Paper out
	Drawer Kick Connector Status (n=2,50)			
	Bit	Status	"0"	"1"
	7	Fixed at 0		
	6	Undefined		
	5	Undefined		
	4	Fixed at 0		
	3	Undefined		
	2	Undefined		
	1	Undefined		
	0	Drawer kick connector pin #3	"L"	"H"

### GS v 0 m xL xH yL yH d1 ... dk

[Name]	Print raster bit image.																
[Format]	ASCII GS v 0 m xL xH yL yH d1...dk Hex. 1D 76 30 m xL xH yL yH d1...dk Decimal 29 118 48 m xL xH yL yH d1...dk																
[Range]	m = 0, m = 48 0 ≤ xL ≤ 54(for 2 inch) 0 ≤ xL ≤ 72(for 3 inch) 0 ≤ xH ≤ 0 0 ≤ yL ≤ 255 0 ≤ yH ≤ 3 0 ≤ d ≤ 255 k = (xL+xH×256) × (yL+yH×256) However, k ≠ 0																
[Description]	Prints raster method bit images using mode m.																
	<table border="1"> <thead> <tr> <th>m</th> <th>Mode</th> <th>Density of Vert. Dir. Dots</th> <th>Density of Hor. Dir. Dots</th> </tr> </thead> <tbody> <tr> <td>0, 48</td> <td>Normal Mode</td> <td>203 DPI</td> <td>203 DPI</td> </tr> </tbody> </table>	m	Mode	Density of Vert. Dir. Dots	Density of Hor. Dir. Dots	0, 48	Normal Mode	203 DPI	203 DPI								
	m	Mode	Density of Vert. Dir. Dots	Density of Hor. Dir. Dots													
0, 48	Normal Mode	203 DPI	203 DPI														
<ul style="list-style-type: none"> <li>xL and xH specify the horizontal direction data count for one bit image (xL + xH × 256) in bytes.</li> <li>yL and yH specify the vertical direction data count for one bit image (yL + yH × 256) in bytes.</li> </ul>																	
	<p>[Ex.:] When xL + xH × 256 = 64</p> <p>(xL+xH×256) × 8dot = 512 dot</p> <p style="text-align: center;"> <table border="1" style="display: inline-table;"> <tr> <td>7</td><td>6</td><td>5</td><td>4</td><td>3</td><td>2</td><td>1</td><td>0</td> </tr> <tr> <td colspan="4" style="text-align: center;">MSB</td> <td colspan="4" style="text-align: center;">LSB</td> </tr> </table> </p>	7	6	5	4	3	2	1	0	MSB				LSB			
7	6	5	4	3	2	1	0										
MSB				LSB													

### GS w n

[Name]	Set bar code width.
[Format]	ASCII GS w n Hex. 1D 77 n Decimal 29 119 n
[Range]	1 ≤ n ≤ 6 Initial Value n = 2



[Description]	Sets the bar code horizontal size.			
	n	Multi-level Bar Code Module Width [mm]	Binary Level Bar Code Fine Element Width[mm]	Thick Element Width[mm]
	1	0.141	0.141	0.423
	2	0.282	0.282	0.706
	3	0.423	0.423	1.129
	4	0.564	0.564	1.411
	5	0.706	0.706	1.834
6	0.847	0.847	2.258	

## TWO-DIMENSIONAL BAR CODE COMMAND DETAILS

### DC2 ; n

[Name]	QR Code Module Size Set
[Format]	ASCII DC ; n Hex. 12 3B n Decimal 18 59 n
[Range]	2 ≤ n ≤ 16 Initial Value n = 2
[Description]	Specifies a module size of QR Code and Data Matrix. n: The number of dots for one side of the module size.

### GS p 1

[Name]	QR Code Print
[Format]	ASCII GS p 1 model e v mode nl nh [data] Hex. 1D 70 01 model e v mode nl nh [data] Decimal 29 112 01 model e v mode nl nh [data]
[Range]	model=01, 02 e=4Ch, 4Dh, 51h, 48h 0, 1 ≤ v ≤ 40 mode=4Eh, 41h, 42h, 4Bh, 4Dh 1 ≤ nh × 256 + n ≤ 7089

[Description]	<p>Prints QRCode data based on the specified contents.          model: Specifies a model          e: Selects an error correction level.            'L' (4CH), 'M' (4DH), 'Q' (51H), 'H' (48H)          v: =0: Automatic selection          (A version is automatically selected depending on the number of input data.)  <math>1 \leq v \leq 40</math> Fixed version (up to 14 for model-1)          mode: Specifies a mode of data.</p> <table border="1" style="margin-left: auto; margin-right: auto;"> <thead> <tr> <th>Mode</th> <th>Hexadecimal</th> <th>Mode</th> </tr> </thead> <tbody> <tr> <td>N</td> <td>4E</td> <td>Numerical mode</td> </tr> <tr> <td>A</td> <td>41</td> <td>Alphanumeric mode</td> </tr> <tr> <td>B</td> <td>42</td> <td>8-bit byte mode</td> </tr> <tr> <td>K</td> <td>4B</td> <td>Kanji mode</td> </tr> <tr> <td>M</td> <td>4D</td> <td>Mixed mode</td> </tr> </tbody> </table> <p>nl, nh: Specifies the number of data.          Data: Kanji data of the QRCode data should be set by Shift JIS code.</p>	Mode	Hexadecimal	Mode	N	4E	Numerical mode	A	41	Alphanumeric mode	B	42	8-bit byte mode	K	4B	Kanji mode	M	4D	Mixed mode
Mode	Hexadecimal	Mode																	
N	4E	Numerical mode																	
A	41	Alphanumeric mode																	
B	42	8-bit byte mode																	
K	4B	Kanji mode																	
M	4D	Mixed mode																	

## KANJI CONTROL COMMAND DETAILS

### FS ! n

[Name]	Set print mode(s) for Kanji characters.		
[Format]	ASCII FS ! n Hex. 1C 21 n Decimal 28 33 n		
[Range]	0 ≤ n ≤ 255 Initial Value n = 0		
[Description]	Batch specifies the Kanji character print mode.		
	Bit	Function	"0"
	7	Underline	Off
	6	Undefined	
	5	Undefined	
	4	Undefined	
	3	Double tall expanded	Off
	2	Expanded wide	Off
	1	Undefined	
	0	Undefined	

### FS &

[Name]	Select Kanji character mode.
[Format]	ASCII FS & Hex. 1C 26 Decimal 28 38
[Range]	N/A
[Description]	Specifies Kanji character mode.

**FS - n**

[Name]	Turn underline mode on/off for Kanji characters								
[Format]	ASCII FS - n Hex. 1C 2D n Decimal 28 45 n								
[Range]	$0 \leq n \leq 2$ , $48 \leq n \leq 50$								
[Description]	Specifies or cancels Kanji character underlines. <table border="1"> <thead> <tr> <th>n</th> <th>Function</th> </tr> </thead> <tbody> <tr> <td>0,48</td> <td>Cancels Kanji character underline</td> </tr> <tr> <td>1,49</td> <td>Sets to one-dot width Kanji character underline and specifies Kanji character underlines.</td> </tr> <tr> <td>2,50</td> <td>Sets to two-dot width Kanji character underline and cancels Kanji character underlines.</td> </tr> </tbody> </table>	n	Function	0,48	Cancels Kanji character underline	1,49	Sets to one-dot width Kanji character underline and specifies Kanji character underlines.	2,50	Sets to two-dot width Kanji character underline and cancels Kanji character underlines.
n	Function								
0,48	Cancels Kanji character underline								
1,49	Sets to one-dot width Kanji character underline and specifies Kanji character underlines.								
2,50	Sets to two-dot width Kanji character underline and cancels Kanji character underlines.								

**FS .**

[Name]	Cancel Kanji character mode.
[Format]	ASCII FS . Hex. 1C 2E Decimal 28 46
[Range]	N/A
[Description]	Cancels Kanji character mode.

**FS S n1 n2**

[Name]	Set Kanji character spacing
[Format]	ASCII FS S n1 n2 Hex. 1C 53 n1 n2 Decimal 28 83 n1 n2
[Range]	$0 \leq n1 \leq 255$ , $0 \leq n2 \leq 255$ Initial Value $n1 = 0$ , $n2 = 0$
[Description]	Sets the Kanji character space amount and right space amount. <ul style="list-style-type: none"> <li>● Left space amount: <math>n1 \times</math> (basic calculated pitch)</li> <li>● Right space amount: <math>n2 \times</math> (basic calculated pitch)</li> </ul>

**FS W n**

[Name]	Turn quadruple-size mode on/off for Kanji characters.
[Format]	ASCII FS W n Hex. 1C 57 n Decimal 28 87 n
[Range]	$0 \leq n \leq 255$ Initial Value $n = 0$
[Description]	Specifies or cancels quadruple size Kanji character. <ul style="list-style-type: none"> <li>● Cancels quadruple size when <math>n = &lt;*****0&gt;B</math>.</li> <li>● Specifies quadruple size when <math>n = &lt;*****1&gt;B</math>.</li> <li>● <math>n</math> is effective only when it is the lowest bit.</li> </ul>

### 3-2-1-2. OPOS Printer Driver

The **MB1030\_OposSetup.exe** program sets up the registry information of MSRHK reader for OPOS program uses.

#### 1. Installation

Below steps guide you to install the **MB1030\_OposSetup** program.

- Run the setup file **MB1030\_OposSetup.exe** located in the Software folder of CD.
- This setup also installs the **MB1030** program.
- Follow the wizard instructions to complete the installation.

#### 2. Launching Program

Below steps guide you to load the **MB1030** program.

- Click *POSPrinter* folder from the path *Start\Programs\Protech OPOS*.
- Click **MB1030** to launch the program.

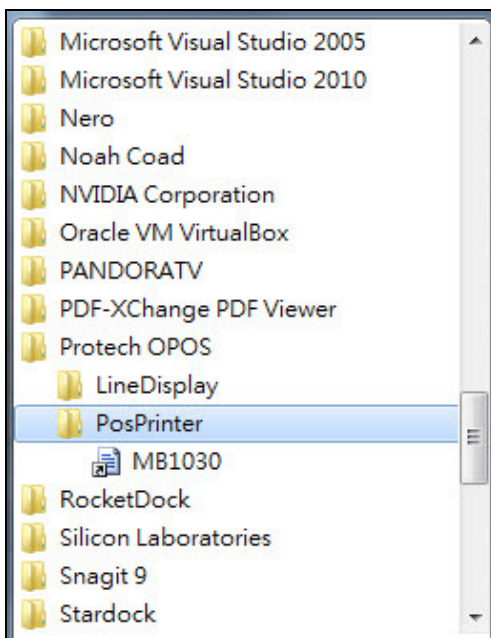

3. OPOS Control Object of MB1030 Program

a.) Print tab buttons:

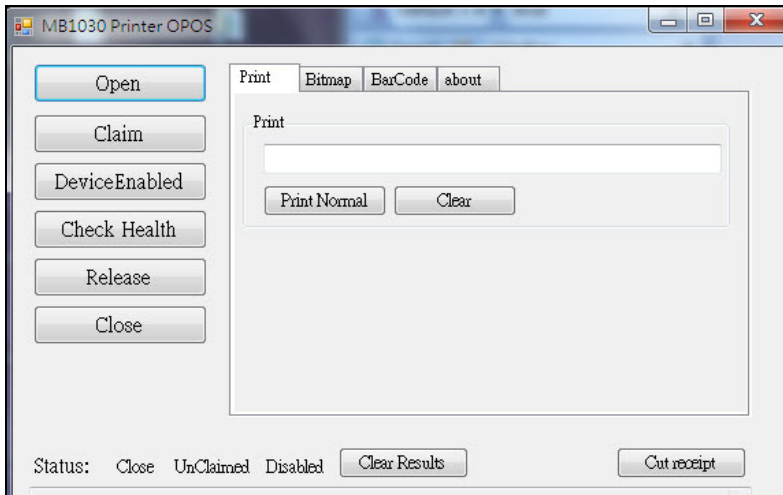

Button/Item	Description
Printer Normal	Print the string.

b.) Bitmap tab buttons/items:

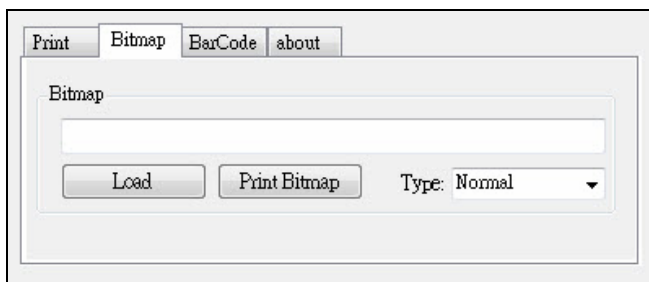

Button/Item	Description
Load	Load bitmap file.
Print Bitmap	Print bitmap file.
Type	Normal or Rotate 108°.

c.) BarCode tab buttons/items:

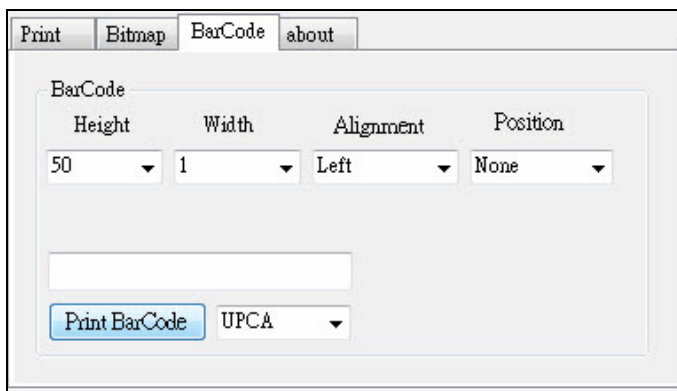

Button/Item	Description
Print BarCode	Print the barcode. Supported barcode types: UPCA, UPCE, EAN8, EAN13, ITF, Codabar, Code39, Code93, Code128
Alignment	Left, center or right
Position	Print barcode number (None, Above or Below)

4. MB1030 type

Key Name	Type	Default Value	Note
BaudRate	String	115200	UART Baud Rate (default)
BitLength	String	8	UART Data Bit (default)
Parity	String	0	UART Parity Bit (default)
Port	String	COM4	UART Port (default)
Stop	String	1	UART Stop Bit (default)

## 5. OPOS APIs Support List

	Category Type	Name	Mutability	OPOS APG Version	Printer .SO
Properties	common bool	AutoDisable	R/W	1.2	Not Applicable
Properties	common long	BinaryConversion	R/W	1.2	Not Applicable
Properties	common long	CapPowerReporting	Read only	1.3	Not Applicable
Properties	common string	CheckHealthText	Read only	1.0	Supported
Properties	common bool	Claimed	Read only	1.0	Supported
Properties	common long	DataCount	Read only	1.2	Not Applicable
Properties	common bool	DataEventEnabled	Read only	1.0	Not Applicable
Properties	common bool	DeviceEnabled	R/W	1.0	Not Applicable
Properties	common bool	FreezeEvents	R/W	1.0	Supported
Properties	common long	OpenResult	Read only	1.5	Supported
Properties	common bool	OutputID	Read only	1.0	Not Applicable
Properties	common bool	PowerNotify	R/W	1.3	Not Applicable
Properties	common bool	PowerState	Read only	1.3	Not Applicable
Properties	common long	ResultCode	Read only	1.0	Supported
Properties	common long	ResultCodeExtended	Read only	1.0	Not Applicable
Properties	common long	State	Read only	1.0	Supported
Properties	common string	ControlObject Description	Read only	1.0	Not Applicable
Properties	common long	ControlObject Version	Read only	1.0	Not Applicable
Properties	common string	ServiceObject Description	Read only	1.0	Supported
Properties	common long	ServiceObject Version	Read only	1.0	Supported
Properties	common string	DeviceDescription	Read only	1.0	Supported
Properties	common string	ControlObject Description	Read only	1.0	Not Applicable
Properties	specific long	CapCharacterSet	Read only	1.1	Not Applicable
Pro.perties	specific bool	CapConcurrentJrnRec	Read only	1.0	Not Applicable
Properties	specific bool	CapConcurrentJrnSlp	Read only	1.0	Not Applicable
Properties	specific bool	CapCoverSensor	Read only	1.0	Not Applicable
Properties	specific bool	CapTransaction	Read only	1.1	Not Applicable
Properties	specific bool	CapJrnPresent	Read only	1.0	Not Applicable
Properties	specific bool	CapJrn2Color	Read only	1.0	Not Applicable
Properties	specific bool	CapJrnBold	Read only	1.0	Not Applicable

	Category Type	Name	Mutability	OPOS APG Version	Printer .SO
Properties	specific long	CapJrnCartridgeSensor	Read only	1.5	Not Applicable
Properties	specific long	CapJrnColor	Read only	1.5	Not Applicable
Properties	specific long	CapJrnDhigh	Read only	1.0	Not Applicable
Properties	specific long	CapJrnDwide	Read only	1.0	Not Applicable
Properties	specific long	CapJrnDwideDhigh	Read only	1.0	Not Applicable
Properties	specific long	CapJrnEmptySensor	Read only	1.0	Not Applicable
Properties	specific long	CapJrnItalic	Read only	1.0	Not Applicable
Properties	specific long	CapJrnNearEndSensor	Read only	1.0	Not Applicable
Properties	specific bool	CapJrnUnderline	Read only	1.0	Not Applicable
Properties	specific bool	CapRecPresent	Read only	1.0	Not Applicable
Properties	specific bool	CapRec2Color	Read only	1.0	Not Applicable
Properties	specific bool	CapRecBarCode	Read only	1.0	Not Applicable
Properties	specific bool	CapRecBitmap	Read only	1.0	Not Applicable
Properties	specific bool	CapRecBold	Read only	1.0	Not Applicable
Properties	specific long	CapRecCartridgeSensor	Read only	1.5	Not Applicable
Properties	specific long	CapRecColor	Read only	1.5	Not Applicable
Properties	specific bool	CapRecDhigh	Read only	1.0	Not Applicable
Properties	Specific bool	CapRecDwide	Read only	1.0	Not Applicable
Properties	specific bool	CapRecDwideDhigh	Read only	1.0	Not Applicable
Properties	specific bool	CapRecEmptySensor	Read only	1.0	Not Applicable
Properties	specific bool	CapRecItalic	Read only	1.0	Not Applicable
Properties	specific bool	CapRecLeft90	Read only	1.0	Not Applicable
Properties	specific bool	CapRecMarkFeed	Read only	1.5	Not Applicable
Properties	specific bool	CapRecNearEndSensor	Read only	1.0	Not Applicable
Properties	specific bool	CapRecPapercut	Read only	1.0	Not Applicable
Properties	specific bool	CapRecRight90	Read only	1.0	Not Applicable
Properties	specific bool	CapRecRotate180	Read only	1.0	Not Applicable
Properties	specific bool	CapRecStamp	Read only	1.0	Not Applicable
Properties	specific bool	CapRecUnderline	Read only	1.0	Not Applicable
Properties	specific bool	CapSlpPresent	Read only	1.0	Not Applicable
Properties	specific bool	CapSlpFullslip	Read only	1.0	Not Applicable
Properties	specific bool	CapSlp2Color	Read only	1.0	Not Applicable
Properties	specific bool	CapSlpBarCode	Read only	1.0	Not Applicable
Properties	specific bool	CapSlpBitmap	Read only	1.0	Not Applicable
Properties	specific bool	CapSlpBold	Read only	1.0	Not Applicable
Properties	specific bool	CapSlpBothSidesPrint	Read only	1.5	Not Applicable



	Category Type	Name	Mutability	OPOS APG Version	Printer .SO
Properties	specific long	CapSlpCartridgeSensor	Read only	1.5	Not Applicable
Properties	specific long	CapSlpColor	Read only	1.5	Not Applicable
Properties	specific bool	CapSlpDhigh	Read only	1.0	Not Applicable
Properties	specific bool	CapSlpDwide	Read only	1.0	Not Applicable
Properties	specific bool	CapSlpDwideDhigh	Read only	1.0	Not Applicable
Properties	specific bool	CapSlpEmptySensor	Read only	1.0	Not Applicable
Properties	specific bool	CapSlpItalic	Read only	1.0	Not Applicable
Properties	specific bool	CapSlpLeft90	Read only	1.0	Not Applicable
Properties	specific bool	CapSlpNearEndSensor	Read only	1.0	Not Applicable
Properties	specific bool	CapSlpRight90	Read only	1.0	Not Applicable
Properties	specific bool	CapSlpRotate180	Read only	1.0	Not Applicable
Properties	specific bool	CapSlpUnderline	Read only	1.0	Not Applicable
Properties	specific bool	AsyncMode	R/W	1.0	Not Applicable
Properties	specific long	CartridgeNotify	R/W	1.5	Not Applicable
Properties	specific long	CharacterSet	R/W	1.0	Not Applicable
Properties	specific string	CharacterSetList	Read only	1.0	Not Applicable
Properties	specific bool	CoverOpen	Read only	1.0	Not Applicable
Properties	specific long	ErrorLevel	Read only	1.1	Not Applicable
Properties	specific long	ErrorStation	Read only	1.0	Not Applicable
Properties	specific string	ErrorString	Read only	1.1	Not Applicable
Properties	specific string	FontTypefaceList	Read only	1.1	Not Applicable
Properties	specific bool	FlagWhenIdle	R/W	1.0	Not Applicable
Properties	specific long	MapMode	R/W	1.0	Not Applicable
Properties	specific long	RotateSpecial	R/W	1.1	Not Applicable
Properties	specific long	JrnLineChars	R/W	1.0	Not Applicable
Properties	specific string	JrnLineCharsList	Read only	1.0	Not Applicable
Properties	specific long	JrnLineHeight	R/W	1.0	Not Applicable
Properties	specific long	JrnLineSpacing	R/W	1.0	Not Applicable
Properties	specific long	JrnLineWidth	Read only	1.0	Not Applicable
Properties	specific bool	JrnLetterQuality	R/W	1.0	Not Applicable
Properties	specific bool	JrnEmpty	Read only	1.0	Not Applicable
Properties	specific bool	JrnNearEnd	Read only	1.0	Not Applicable
Properties	specific long	JrnCartridgeState	Read only	1.5	Not Applicable
Properties	specific long	JrnCurrentCartridge	R/W	1.5	Not Applicable
Properties	specific long	RecLineChars	R/W	1.0	Not Applicable
Properties	specific string	RecLineCharsList	Read only	1.0	Not Applicable

	Category Type	Name	Mutability	OPOS APG Version	Printer .SO
Properties	specific long	RecLineHeight	R/W	1.0	Not Applicable
Properties	specific long	RecLineSpacing	R/W	1.0	Not Applicable
Properties	specific long	RecLineWidth	Read only	1.0	Not Applicable
Properties	specific bool	RecLetterQuality	R/W	1.0	Not Applicable
Properties	specific bool	RecEmpty	Read only	1.0	Not Applicable
Properties	specific bool	RecNearEnd	Read only	1.0	Not Applicable
Properties	specific long	RecSidewaysMaxLines	Read only	1.0	Not Applicable
Properties	specific long	RecSidewaysMaxChars	Read only	1.0	Not Applicable
Properties	specific long	RecLinesToPaperCut	Read only	1.0	Not Applicable
Properties	specific string	RecBarCodeRotationList	Read only	1.1	Not Applicable
Properties	specific long	RecCartridgeState	Read only	1.5	Not Applicable
Properties	specific long	RecCurrentCartridge	R/W	1.5	Not Applicable
Properties	specific long	SlpLineChars	R/W	1.0	Not Applicable
Properties	specific string	SlpLineCharsList	Read only	1.0	Not Applicable
Properties	specific long	SlpLineHeight	R/W	1.0	Not Applicable
Properties	specific long	SlpLineSpacing	R/W	1.0	Not Applicable
Properties	specific long	SlpLineWidth	Read only	1.0	Not Applicable
Properties	specific bool	SlpLetterQuality	R/W	1.0	Not Applicable
Properties	specific bool	SlpEmpty	Read only	1.0	Not Applicable
Properties	specific bool	SlpNearEnd	Read only	1.0	Not Applicable
Properties	specific long	SlpSidewaysMaxLines	Read only	1.0	Not Applicable
Properties	specific long	SlpSidewaysMaxChars	Read only	1.0	Not Applicable
Properties	specific long	SlpMaxLines	Read only	1.0	Not Applicable
Properties	specific long	SlpLinesNearEndToEnd	Read only	1.0	Not Applicable
Properties	specific string	SlpBarCodeRotationList	Read only	1.1	Not Applicable
Properties	specific long	SlpPrintSide	Read only	1.5	Not Applicable
Properties	specific long	SlpCartridgeState	Read only	1.5	Not Applicable
Properties	specific long	SlpCurrentCartridge	R/W	1.5	Not Applicable
Methods	common	Open	-	1.0	Supported
Methods	common	Close	-	1.0	Supported
Methods	common	Claim	-	1.0	Supported
Methods	common	ClaimDevice	-	1.0	Supported
Methods	common	Release	-	1.0	Supported
Methods	common	ReleaseDevice	-	1.0	Supported
Methods	common	CheckHealth	-	1.0	Supported
Methods	common	ClearInput	-	1.0	Not Applicable

	Category Type	Name	Mutability	OPOS APG Version	Printer .SO
Methods	common	ClearOutput	-	1.0	Not Applicable
Methods	common	DirectIO	-	1.0	Not Applicable
Methods	specific	PrintNormal	-	1.0	Supported
Methods	specific	PrintTwoNormal	-	1.0	Not Applicable
Methods	specific	PrintImmediate	-	1.0	Not Applicable
Methods	specific	BeginInsertion	-	1.0	Not Applicable
Methods	specific	EndInsertion	-	1.0	Not Applicable
Methods	specific	BeginRemoval	-	1.0	Not Applicable
Methods	specific	EndRemoval	-	1.0	Not Applicable
Methods	specific	CutPaper	-	1.0	Supported
Methods	specific	RotatePrint	-	1.0	Supported (only 180)
Methods	specific	PrintBarCode	-	1.0	Supported
Methods	specific	PrintBitmap	-	1.0	Supported
Methods	specific	TransactionPrint	-	1.1	Not Applicable
Methods	specific	ValidateData	-	1.1	Not Applicable
Methods	specific	SetBitmap	-	1.0	Not Applicable
Methods	specific	SetLogo	-	1.0	Not Applicable
Methods	specific	ChangePrintSide	-	1.5	Not Applicable
Methods	specific	MarkFeed	-	1.5	Not Applicable
Events	common	DataEvent	-	1.0	Not Applicable
Events	common	DirectIOEvent	-	1.0	Not Applicable
Events	common	ErrorEvent	-	1.0	Not Applicable
Events	common	OutputComplete Event	-	1.0	Not Applicable
Events	common	StatusUpdate Event	-	1.0	Not Applicable

## 3-2-2. VFD: MB-4103 (RS-232)

### 3-2-2-1. Command List

#### 1. VFD Registry Operation

Registry Path: [HKEY\_LOCAL\_MACHINE\SOFTWARE\OLEforRetail\ServiceOPOS\LineDisplay\Prox-PMP4000]

Registry Name	Default Data	Notes
Default Value	LineDisplay.PMP4000.1	-
BaudRate	9600	-
BitLength	8	-
Parity	0	-
Port	COM1	-
Stop	1	-

#### 2. OPOS VFD Service Object and Method Relations

Method	Status of support	Notes
Open	○	-
Close	○	-
ClaimDevice	○	-
ReleaseDevice	○	-
Enable	○	-
Disable	○	-
DisplayText	○	-
DisplayTextAt	○	-
ClearText	○	-

### 3-2-2-2. OPOS Driver

The **MB4000\_OposSetup.exe** program sets up the registry information and example program of VFD for OPOS program uses.

#### 1. Installation

Below steps guide you to install the **MB4000\_OposSetup** program.

- Run the **MB4000\_OposSetup** setup file
- This setup also installs the **Prox-PMP4000** program.
- Follow the wizard instructions to complete the installation.

#### 2. Launching Program

Below steps guide you to load the **Prox-PMP4000** program.

- Click *LineDisplay* folder from the path *Start/Programs/Protech OPOS*.
- Click **Prox-PMP4000** to launch the program.

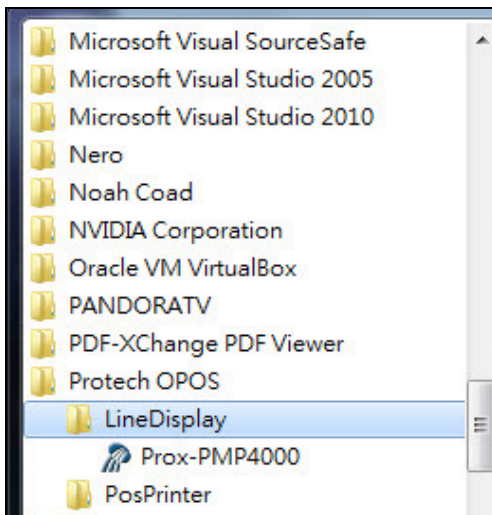

3. OPOS Control Object of **Prox-PMP4000** program

Main screen buttons:

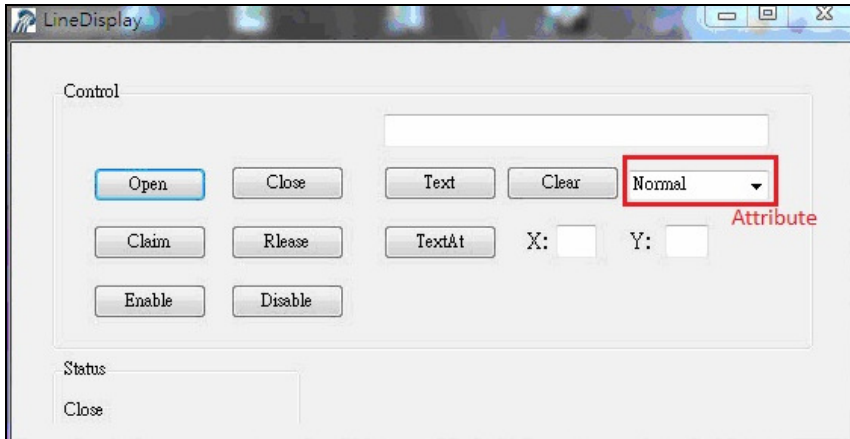

Button/Item	Description
Text	Display text at the current cursor position.
TextAt	Display the string of characters at the specified “y ” and “x ”.
Clear	Clear the current window by displaying
Attribute	Normal, blink, reverse, blink, reverse

4. MB4103 type

Key Name	Type	Default Value	Note
BaudRate	String	9600	UART Baud Rate (default)
BitLength	String	8	UART Data Bit (default)
Parity	String	0	UART Parity Bit (default)
Port	String	COM1	UART Port (default)
Stop	String	1	UART Stop Bit (default)

## 5. OPOS APIs Support List

	Category Type	Name	Mutability	OPOS APG Version	VFD .SO
Properties	common bool	AutoDisable	R/W	1.2	Not Applicable
Properties	common long	BinaryConversion	R/W	1.2	Not Applicable
Properties	common long	CapPowerReporting	Read only	1.3	Not Applicable
Properties	common string	CheckHealthText	Read only	1.0	Supported
Properties	common bool	Claimed	Read only	1.0	Supported
Properties	common long	DataCount	Read only	1.2	Not Applicable
Properties	common bool	DataEventEnabled	Read only	1.0	Not Applicable
Properties	common bool	DeviceEnabled	R/W	1.0	Not Applicable
Properties	common bool	FreezeEvents	R/W	1.0	Not Applicable
Properties	common long	OpenResult	Read only	1.5	Not Applicable
Properties	common bool	OutputID	Read only	1.0	Not Applicable
Properties	common bool	PowerNotify	R/W	1.3	Not Applicable
Properties	common bool	PowerState	Read only	1.3	Not Applicable
Properties	common long	ResultCode	Read only	1.0	Supported
Properties	common long	ResultCodeExtended	Read only	1.0	Not Applicable
Properties	common long	State	Read only	1.0	Supported
Properties	common string	ControlObject Description	Read only	1.0	Not Applicable
Properties	common long	ControlObject Version	Read only	1.0	Not Applicable
Properties	common string	ServiceObject Description	Read only	1.0	Supported
Properties	common long	ServiceObject Version	Read only	1.0	Supported
Properties	common string	DeviceDescription	Read only	1.0	Supported
Properties	common string	ControlObject Description	Read only	1.0	Not Applicable
Properties	specific long	CapBlink	Read only	1.0	Not Applicable
Properties	specific bool	CapBlinkRate	Read only	1.6	Not Applicable
Properties	specific bool	CapBrightness	Read only	1.0	Not Applicable
Properties	specific long	CapCharacterSet	Read only	1.0	Not Applicable
Properties	specific long	CapCursorType	Read only	1.6	Not Applicable
Properties	specific bool	CapCustomGlyph	Read only	1.6	Not Applicable
Properties	specific bool	CapDescriptors	Read only	1.0	Not Applicable
Properties	specific bool	CapHMarquee	Read only	1.0	Not Applicable

	Category Type	Name	Mutability	OPOS APG Version	VFD .SO
Properties	specific bool	CapICharWait	Read only	1.0	Not Applicable
Properties	specific long	CapReadBack	Read only	1.6	Not Applicable
Properties	specific long	CapReverse	Read only	1.6	Not Applicable
Properties	specific bool	CapVMarquee	Read only	1.0	Not Applicable
Properties	specific long	BlinkRate	R/W	1.6	Not Applicable
Properties	specific long	DeviceWindows	Read only	1.0	Not Applicable
Properties	specific long	DeviceRows	Read only	1.0	Not Applicable
Properties	specific long	DeviceColumns	Read only	1.0	Not Applicable
Properties	specific long	DeviceDescriptors	Read only	1.0	Not Applicable
Properties	specific long	DeviceBrightness	R/W	1.0	Not Applicable
Properties	specific long	CharacterSet	R/W	1.0	Not Applicable
Properties	specific string	CharacterSetList	Read only	1.0	Not Applicable
Properties	specific long	CurrentWindow	R/W	1.0	Not Applicable
Properties	specific long	Rows	Read only	1.0	Not Applicable
Properties	specific long	Columns	Read only	1.0	Not Applicable
Properties	specific long	CursorRow	R/W	1.0	Not Applicable
Properties	specific long	CursorColumn	R/W	1.0	Not Applicable
Properties	specific long	CursorType	R/W	1.6	Not Applicable
Properties	specific bool	CursorUpdate	R/W	1.0	Not Applicable
Properties	specific long	MarqueeType	R/W	1.0	Not Applicable
Properties	specific long	MarqueeFormat	R/W	1.0	Not Applicable
Properties	specific long	MarqueeUnitWait	R/W	1.0	Not Applicable
Properties	specific long	MarqueeRepeatWait	R/W	1.0	Not Applicable
Properties	specific long	InterCharacterWait	R/W	1.0	Not Applicable
Properties	specific string	CustomGlyphList	Read only	1.6	Not Applicable
Properties	specific long	GlyphHeight	Read only	1.6	Not Applicable
Properties	specific long	GlyphWidth	Read only	1.6	Not Applicable
Methods	common	Open	-	1.0	Supported
Methods	common	Close	-	1.0	Supported
Methods	common	Claim	-	1.0	Supported
Methods	common	ClaimDevice	-	1.0	Supported
Methods	common	Release	-	1.0	Supported
Methods	common	ReleaseDevice	-	1.0	Supported
Methods	common	CheckHealth	-	1.0	Not Applicable
Methods	common	ClearInput	-	1.0	Not Applicable
Methods	common	ClearOutput	-	1.0	Not Applicable



	Category Type	Name	Mutability	OPOS APG Version	VFD .SO
Methods	common	DirectIO	-	1.0	Not Applicable
Methods	specific	DisplayText	-	1.0	Supported
Methods	specific	DisplayTextAt	-	1.0	Supported
Methods	specific	ClearText	-	1.0	Supported
Methods	specific	ScrollText	-	1.0	Not Applicable
Methods	specific	SetDescriptor	-	1.0	Not Applicable
Methods	specific	ClearDescriptors	-	1.0	Not Applicable
Methods	specific	CreateWindow	-	1.0	Not Applicable
Methods	specific	DestroyWindow	-	1.0	Not Applicable
Methods	specific	RefreshWindow	-	1.0	Not Applicable)
Methods	specific	ReadCharacterAtCursor	-	1.6	Not Applicable
Methods	specific	DefineGlyph	-	1.6	Not Applicable
Events	common	DataEvent	-	1.0	Not Applicable
Events	common	DirectIOEvent	-	1.0	Not Applicable
Events	common	ErrorEvent	-	1.0	Not Applicable
Events	common	OutputComplete Event	-	1.0	Not Applicable
Events	common	StatusUpdate Event	-	1.3	Not Applicable

### 3-2-3. MSR: MB-3012 (PS/2)

#### 3-2-3-1. OPOS Driver

The **MB301X\_OposSetup.exe** program sets up the registry information of MSR reader for OPOS program uses.

##### 1. Installation

Below steps guide you to install the **MB301X\_OposSetup** program.

- Run the **OPOSMSR\_Setup.exe** setup file.
- This setup also installs the Prox-PMP3000 program.
- Follow the wizard instructions to complete the installation.

##### 2. Launching Program

Below steps guide you load the Prox-PMP3000 program.

- Click *MSR* folder from the path *Start/Programs/Protech OPOS*.
- Click **Prox-PMP3000** to launch the program.

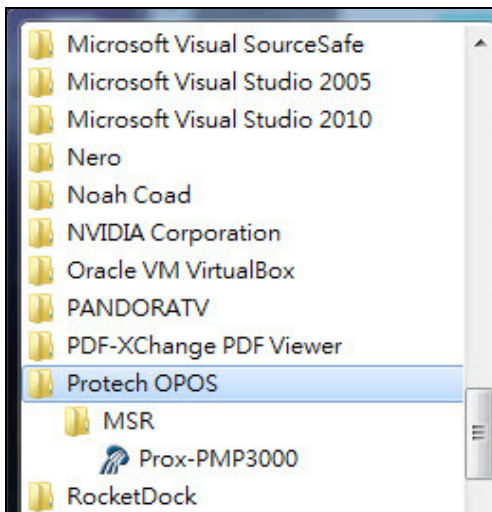

3. Configuration of **Prox-PMP3000** program

a.) Main screen & Control tab items:

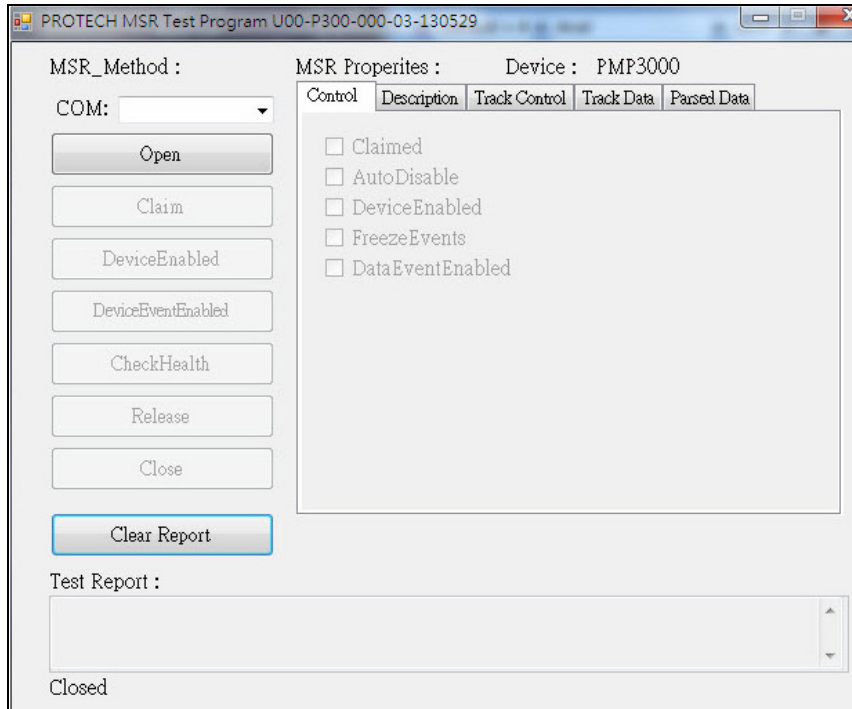

Button/Item	Description
COM	(dropdown list) To set COM port number (only for USRT/USB interface).
AutoDisable	(check box) Set auto-disable
FreezeEvents	(check box) Set freeze events

## b.) Description tab: S.O and C.O information

Control	Description	Track Control	Track Data	Parsed Data
DeviceControlDescription :				
OPOS MSR Control 1.6.000 [Public, by CRM/RCS-Dayton]				
DeviceControlVersion :				
1006000				
DeviceServiceDescription :				
PROTECH OPOS MSR Service Object				
DeviceServiceVersion :				
1007550				
PhysicalDeviceDescription :				
PROTECH OPOS MSR				
PhysicalDeviceName :				
OPOS.PMP3000MSR.SO				

## c.) Track Control tab items

Control	Description	Track Control	Track Data	Parsed Data
<input checked="" type="checkbox"/>	DecodeData	ErrorReporting Type :		
<input checked="" type="checkbox"/>	ParseDecodeData	CARD		
<input type="checkbox"/>	TransmitSentinels	TracksToRead :		
		Tracks123		

Button/Item	Description
DecodeData	Set decode data properties applicable).
ParseDecodeData	Set parse decode data properties
TransmitSentinels	Set transmit-sentinels properties
ErrorReporting Type	Card, track
TracksToRead	Track1, track2, track3, tracks12, tracks13, tracks14, tracks23, tracks24, tracks34, tracks123, tracks124, tracks134, tracks234, tracks1234 (Tracks4 is not applicable).

d.) Track Data tab items

The screenshot shows a software window with five tabs: 'Control', 'Description', 'Track Control', 'Track Data', and 'Parsed Data'. The 'Track Data' tab is active. It contains the following labels and input fields:

- Track1Data : [input field]
- Track1DiscretionaryData : [input field]
- Track2Data : [input field]
- Track2DiscretionaryData : [input field]
- Track3Data : [input field]
- Track4Data : [input field]

Button/Item	Description
TracksData	(Row) Display data of all tracks (Track4 is not applicable).

e.) Parsed Data tab items

The screenshot shows a software window with five tabs: 'Control', 'Description', 'Track Control', 'Track Data', and 'Parsed Data'. The 'Parsed Data' tab is active. It contains the following labels and input fields:

- AccountNumber : [input field]
- ExpirationDate : [input field]
- FirstName : [input field]
- MiddleInitial : [input field]
- Surname : [input field]
- Title : [input field]
- Suffix : [input field]
- ServiceCode : [input field]

Button/Item	Description
Parsed Data	Display special properties.

## 4. MB301X type (RS232/PS2)

Key Name	Type	Default Value	Note
default	string	PMP3000	OPOS S.O Link

## 5. OPOS APIs support List

	Category Type	Name	Mutability	OPOS APG Version	VFD .SO
Properties	common bool	AutoDisable	R/W	1.2	Supported
Properties	common long	BinaryConversion	R/W	1.2	Not Applicable
Properties	common long	CapPowerReporting	Read only	1.3	Supported
Properties	common string	CheckHealthText	Read only	1.0	Supported
Properties	common bool	Claimed	Read only	1.0	Supported
Properties	common long	DataCount	Read only	1.2	Supported
Properties	common bool	DataEventEnabled	R/W	1.0	Supported
Properties	common bool	DeviceEnabled	R/W	1.0	Supported
Properties	common bool	FreezeEvents	R/W	1.0	Supported
Properties	common long	OpenResult	Read only	1.5	Supported
Properties	common long	OutputID	Read only	1.0	Not Applicable
Properties	common long	PowerNotify	R/W	1.3	Not Applicable
Properties	common long	PowerState	Read only	1.3	Not Applicable
Properties	common long	ResultCode	Read only	1.0	Supported
Properties	common long	ResultCodeExtended	Read only	1.0	Supported
Properties	common long	State	Read only	1.0	Not Applicable
Properties	common string	ControlObject Description	Read only	1.0	Not Applicable
Properties	common long	ControlObjectVersion	Read only	1.0	Not Applicable
Properties	common string	ServiceObject Description	Read only	1.0	Supported
Properties	common long	ServiceObjectVersion	Read only	1.0	Not Applicable
Properties	common string	DeviceDescription	Read only	1.0	Supported
Properties	common string	DeviceName	Read only	1.0	Supported
Properties	specific bool	CapISO	Read only	1.0	Supported
Properties	specific bool	CapJISOne	Read only	1.0	Supported
Properties	specific bool	CapJISTwo	Read only	1.0	Supported
Properties	specific bool	CapTransmitSentinels	Read only	1.5	Supported

	Category Type	Name	Mutability	OPOS APG Version	VFD .SO
Properties	specific long	TracksToRead	R/W	1.0	Supported
Properties	specific bool	DecodeData	R/W	1.0	Not Applicable
Properties	specific bool	ParseDecodeData	R/W	1.0	Supported
Properties	specific long	ErrorReportType	R/W	1.2	Not Applicable
Properties	specific string	Track1Data	Read only	1.0	Supported
Properties	specific string	Track2Data	Read only	1.0	Supported
Properties	specific string	Track3Data	Read only	1.0	Supported
Properties	specific string	Track4Data	Read only	1.5	Not Applicable
Properties	specific string	AccountNumber	Read only	1.0	Supported
Properties	specific string	ExpirationDate	Read only	1.0	Supported
Properties	specific string	Title	Read only	1.0	Supported
Properties	specific string	FirstName	Read only	1.0	Supported
Properties	specific string	MiddleInitial	Read only	1.0	Supported
Properties	specific string	Surname	Read only	1.0	Supported
Properties	specific string	Suffix	Read only	1.0	Supported
Properties	specific string	ServiceCode	Read only	1.0	Supported
Properties	specific binary	Track1 DiscretionaryData	Read only	1.0	Supported
Properties	specific binary	Track2 DiscretionaryData	Read only	1.0	Supported
Properties	specific bool	TransmitSentinels	R/W	1.5	Supported
Methods	common	Open	-	1.0	Supported
Methods	common	Close	-	1.0	Supported
Methods	common	Claim	-	1.0	Supported
Methods	common	ClaimDevice	-	1.5	Supported
Methods	common	Release	-	1.0	Supported
Methods	common	ReleaseDevice	-	1.5	Supported
Methods	common	CheckHealth	-	1.0	Not Applicable
Methods	common	ClearInput	-	1.0	Supported
Methods	common	ClearOutput	-	1.0	Not Applicable
Methods	common	DirectIO	-	1.0	Not Applicable
Events	common	DataEvent	-	1.0	Supported
Events	common	DirectIOEvent	-	1.0	Not Applicable
Events	common	ErrorEvent	-	1.0	Not Applicable
Events	common	OutputCompleteEvent	-	1.0	Not Applicable
Events	common	StatusUpdateEvent	-	1.0	Not Applicable

### 3-2-4. MSR: GIGA-TMS MJR243R (RS-232)

#### 3-2-4-1. Command List

##### 1. MSR Registry Operation

Registry Path: [HKEY\_LOCAL\_MACHINE\SOFTWARE\OLEforRetail\ServiceOPOS\MSRMJR243]

Registry Name	Default Data	Notes
CapISO	1	Capability for reading ISO track data
CapJISOne	1	(reserved)
CapJISTwo	1	(reserved)
CapTransmitSentinels	1	Capability for reading Transmit Sentinels
Debug	0	Enable the tracing, and create a log file
Description	GIGATMS MSR POS	Description for SO driver
DeviceName	MJR243	Devive Name for CO open
FileName	(NULL)	(reserved)
HardwareProvider	0	(reserved)
Model	MJR243	Device model name
Parity	None	Parity for the communication port
Port	COM4	Comport
Protocol	Hardware	Communication Control
Baudrate	19200	RS232 baudrate



## 2. OPOS MSR Service Object and Method Relations

Method	Status of support by the driver	Notes
Open	○	-
Close	○	-
Claim	○	-
ClaimDevice	○	-
Release	○	-
ReleaseDevice	○	-
ClearInput	○	-
ClearInputProperties	○	-
DataEvent	○	-
Claimed	○	Read only
DataCount	○	Read only
DataEventEnabled	○	R/W
DeviceEnabled	○	R/W
FreezeEvents	○	R/W
OpenResult	○	Read only
ResultCode	○	Read only
ResultCodeExtended	○	Read only
State	○	Read only
ControlObjectDescription	○	Read only
ControlObjectVersion	○	Read only
ServiceObjectDescription	○	Read only
ServiceObjectVersion	○	Read only
DeviceDescription	○	Read only
DeviceName	○	Read only
CapISO	○	Read only
CapTransmitSentinels	○	Read only
AccountNumber	○	Read only
DecodeData	○	R/W
ExpirationDate	○	Read only
FirstName	○	Read only
MiddleInitial	○	Read Only
ParseDecodeData	○	R/W

<b>Method</b>	<b>Status of support by the driver</b>	<b>Notes</b>
ServiceCode	○	Read Only
Suffix	○	Read Only
Surname	○	Read Only
Title	○	Read Only
Track1Data	○	Read Only
Track1DiscretionaryData	○	Read Only
Track2Data	○	Read Only
Track2DiscretionaryData	○	Read Only
Track3Data	○	Read Only
TracksToRead	○	R/W
TransmitSentinels	○	R/W

### 3-2-4-2. OPOS MSR Register

The **OPOS MSR Register** program sets up the registry information of MSRHK reader for OPOS program uses.

#### 1. Installation

Below steps guide you to install the **OPOS MSR Register** program.

- Insert the setup CD
- Run the setup file **OPOSMSR\_Setup.exe** located in the Software folder of CD.
- This setup also installs the **OPOS MSR Tester** program.
- Follow the wizard instructions to complete the installation.

#### 2. Launching Program

Below steps guide you to load the **OPOS MSR Register** program.

- Click *OPOS* folder from the path *Start/Programs/GIGA-TMS*.
- Click **OPOS MSR Register** to launch the program.

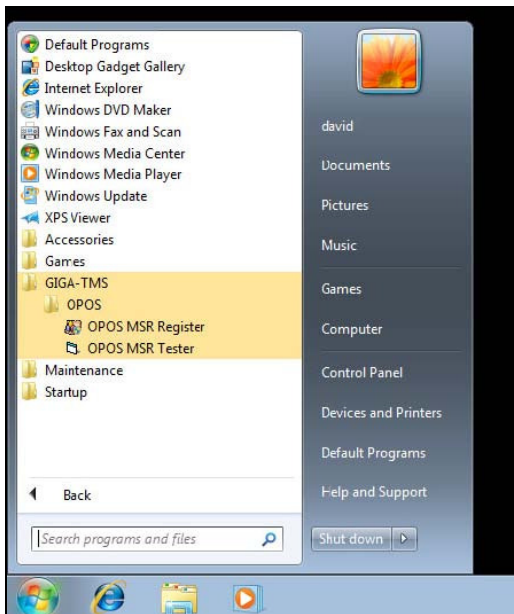

## 3. Configuration of OPOS MSR Register program

## a.) Main screen buttons/items:

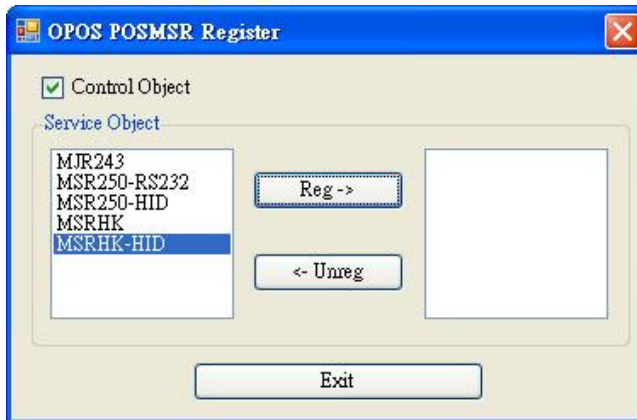

Button/Item	Description
Control Object	(Check box) Register the OPOSMSR.ocx common control object driver. This needs to be checked to run the OPOS MSR Tester program.
Service Object	(Left pane) The Service Object driver types. So far only four types are supported. Each type support specific MSR readers. For more details, please refer to the section <i>OPOS MSR Service Object and Method Relations</i> .
Service Object	(Right pane) The registered MSR with specified device name.
Reg→	Create a new device name for selected MSR.
← Unreg	Remove selected device name from registry.
Exit	End the program.

## b.) Follow the steps below to register the MSRHK OPOS information.

Step 1: Select an item in **Service Object** List box (left pane). Make sure the correct item is selected.

Step 2: Click **Reg→** button

Step 3: In the **OPOS MSR Setting** screen, enter the device name and click **OK**.

c.) Example 1. MAGTEK USB HID

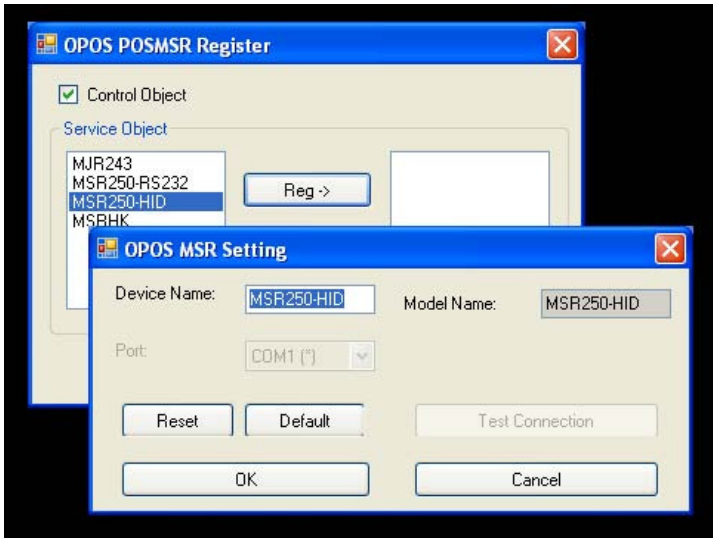

d.) Example 2. PROMAG MSR/MJR PART -NO, Keyboard mode.



e.) Example 3. PROGRAM MSR PART -NO, HID mode.

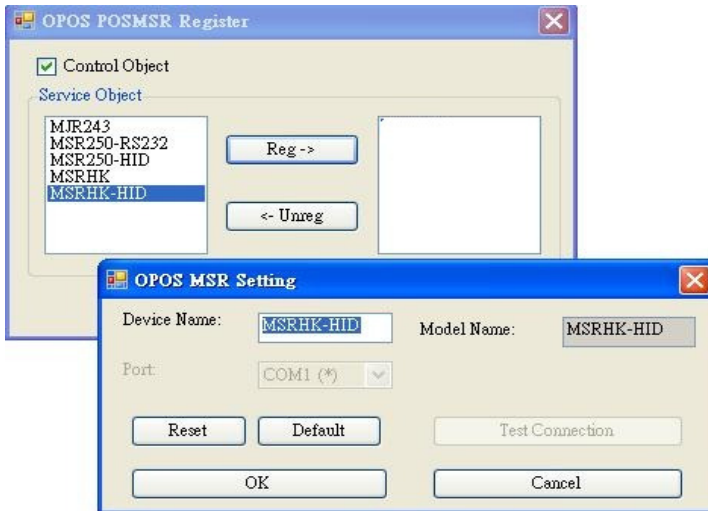

If your system doesn't have any other common control driver, then click Control Object check box.

**Note:** To run the **OPOPS MSR Tester** program, the Control Object must be checked.

#### 4. MJR243 type

Key Name	Type	Default Value	Note
CapISO	string	1	Capability for reading ISO track data
CapJISOne	string	1	(reserved)
CapJISTwo	string	1	(reserved)
CapTransmitSentinels	string	1	Capability for reading Transmit Sentinels
Debug	string	0	Enable the tracing, and create a log file
Description	string	GIGATMS MSR POS	Description for SO driver
DeviceName	string	MJR243	Devive Name for CO open
FileName	string	(NULL)	(reserved)

Key Name	Type	Default Value	Note
HardwareProvider	string	0	(reserved)
Model	string	MJR243	Device model name
Parity	string	None	Parity for the communication port
Port	string	COM4	Comport Number
Protocol	string	Hardware	Communication Control
Baudrate	string	19200	RS232 baudrate

### 5. OPOS APIs support list

	Category Type	Name	Mutability	OPOS APG Version	MSR .SO
Properties	common bool	AutoDisable	R/W	1.2	Not Applicable
Properties	common long	BinaryConversion	R/W	1.2	Not Applicable
Properties	common bool	CapCompare FirmwareVersion	Read only	1.9	Not Applicable
Properties	common long	CapPowerReporting	Read only	1.3	Not Applicable
Properties	common bool	CapStatisticsReporting	Read only	1.8	Not Applicable
Properties	common bool	CapUpdateFirmware	Read only	1.9	Not Applicable
Properties	common bool	CapUpdateStatistics	Read only	1.8	Not Applicable
Properties	common string	CheckHealthText	Read only	1.0	Not Applicable
Properties	common bool	Claimed	Read only	1.0	Supported
Properties	common long	DataCount	Read only	1.2	Supported
Properties	common bool	DataEventEnabled	R/W	1.0	Supported
Properties	common bool	DeviceEnabled	R/W	1.0	Supported
Properties	common bool	FreezeEvents	R/W	1.0	Supported
Properties	common long	OpenResult	Read only	1.5	Supported
Properties	common long	OutputID	Read only	1.0	Not Applicable
Properties	common long	PowerNotify	R/W	1.3	Not Applicable
Properties	common long	PowerState	Read only	1.3	Not Applicable
Properties	common long	ResultCode	Read only	1.0	Supported
Properties	common long	ResultCodeExtended	Read only	1.0	Supported
Properties	common long	State	Read only	1.0	Supported
Properties	common string	ControlObject Description	Read only	1.0	Supported
Properties	common long	ControlObjectVersion	Read only	1.0	Supported
Properties	common	ServiceObject	Read only	1.0	Supported

	Category Type	Name	Mutability	OPOS APG Version	MSR .SO
	string	Description			
Properties	common long	ServiceObjectVersion	Read only	1.0	Supported
Properties	common string	DeviceDescription	Read only	1.0	Supported
Properties	common string	DeviceName	Read only	1.0	Supported
Properties	specific bool	CapISO	Read only	1.0	Supported
Properties	specific bool	CapJISOOne	Read only	1.0	Not Applicable
Properties	specific bool	CapJISTwo	Read only	1.0	Not Applicable
Properties	specific bool	CapTransmit Sentinels	Read only	1.5	Supported
Properties	specific long	CapWriteTracks	Read only	1.1	Not Applicable
Properties	specific string	AccountNumber	Read only	1.0	Supported
Properties	specific bool	DecodeData	R/W	1.0	Supported
Properties	specific long	EncodingMaxLength	Read only	1.1	Not Applicable
Properties	specific long	ErrorReportType	R/W	1.2	Not Applicable
Properties	specific string	ExpirationDate	Read only	1.0	Supported
Properties	specific string	FirstName	Read only	1.0	Supported
Properties	specific string	MiddleInitial	Read only	1.0	Supported
Properties	specific bool	ParseDecodeData	R/W	1.0	Supported
Properties	specific string	ServiceCode	Read only	1.0	Supported
Properties	specific string	Suffix	Read only	1.0	Supported
Properties	specific string	Surname	Read only	1.0	Supported
Properties	specific string	Title	Read only	1.0	Supported
Properties	specific binary	Track1Data	Read only	1.0	Supported
Properties	specific binary	Track1 DiscretionaryData	Read only	1.0	Supported
Properties	specific binary	Track2Data	Read only	1.0	Supported
Properties	specific binary	Track2 DiscretionaryData	-	1.0	Supported
Properties	specific binary	Track3Data	Read only	1.0	Supported
Properties	specific binary	Track4Data	Read only	1.5	Not Applicable
Properties	specific long	TracksToRead	R/W	1	Supported



	Category Type	Name	Mutability	OPOS APG Version	MSR .SO
Properties	specific long	TracksToWrite	R/W	1.1	Not Applicable
Properties	specific bool	TransmitSentinels	R/W	1.5	Supported
Methods	common	Open	-	1	Supported
Methods	common	Close	-	1	Supported
Methods	common	Claim	-	1	Supported
Methods	common	ClaimDevice	-	1.5	Supported
Methods	common	Release	-	1	Supported
Methods	common	ReleaseDevice	-	1.5	Supported
Methods	common	CheckHealth	-	1	Not Applicable
Methods	common	ClearInput	-	1	Supported
Methods	common	ClearInput Properties	-	1.1	Supported
Methods	common	ClearOutput	-	1	Not Applicable
Methods	common	DirectIO	-	1	Not Applicable
Methods	common	Compare FirmwareVersion	-	1.9	Not Applicable
Methods	common	ResetStatistics	-	1.8	Not Applicable
Methods	common	RetrieveStatistics	-	1.8	Not Applicable
Methods	common	UpdateFirmware	-	1.9	Not Applicable
Methods	common	UpdateStatistics	-	1.8	Not Applicable
Events	common	DataEvent	-	1.0	Supported
Events	common	DirectIOEvent	-	1.0	Not Applicable
Events	common	ErrorEvent	-	1.0	Not Applicable
Events	common	OutputCompleteEvent	-	1.0	Not Applicable
Events	common	StatusUpdateEvent	-	1.0	Not Applicable

### 3-2-4-3. OPOS MSR Tester

The **OPOS MSR Tester** program is used to get the track data of MSRHK reader via the OPOS driver. Before running the program, make sure the device name registry information for MSRHK reader has been already created by OPOS MSR Register program.

#### 1. Installation

The installation of **OPOS MSR Tester** program goes together with OPOS MSR Register program.

#### 2. Launching Program

Below steps guide you to load the **OPOS MSR Tester** program.

- Click *OPOS* folder from the path *Start\Programs\GIGA -TMS*.
- Click **OPOS MSR Tester** to launch the program.

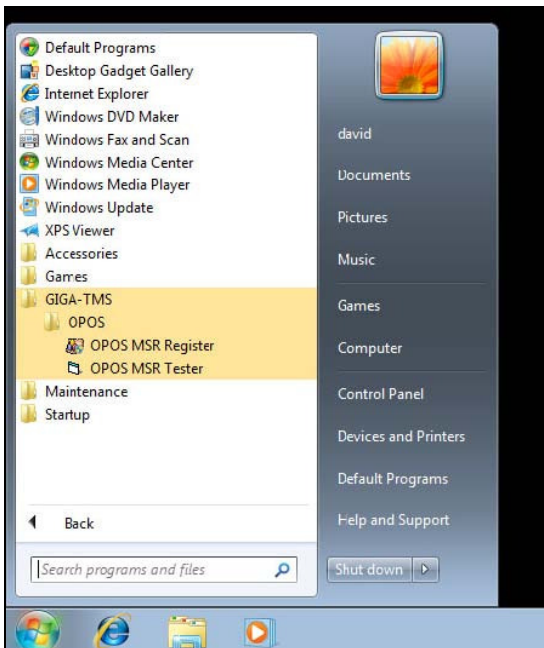

## 3. Configuration for OPOS MSR Tester Program

## a.) Main screen buttons/items:

Button/Item	Description
Device Name	(Combo box) Enter the device name that to be loaded to the program.
Track Data	(Text boxes) Show the raw and parsed track data.
Clear	(Button) Clear all the track data in the text boxes.
Open	(Button) Open the OPOS driver and ready to get track data.
Close	(Button) Close the OPOS driver.
Message	(Text box) Display the result message of running the OPOS driver.

## b.) To start using OPOS driver to get track data, follow the steps below.

Step 1: Entering the **Device Name**.

Step 2: Clicking **Open** button.

Step 3: Swiping card to get track data.

c.) Example 1. MAGTEK USB HID.

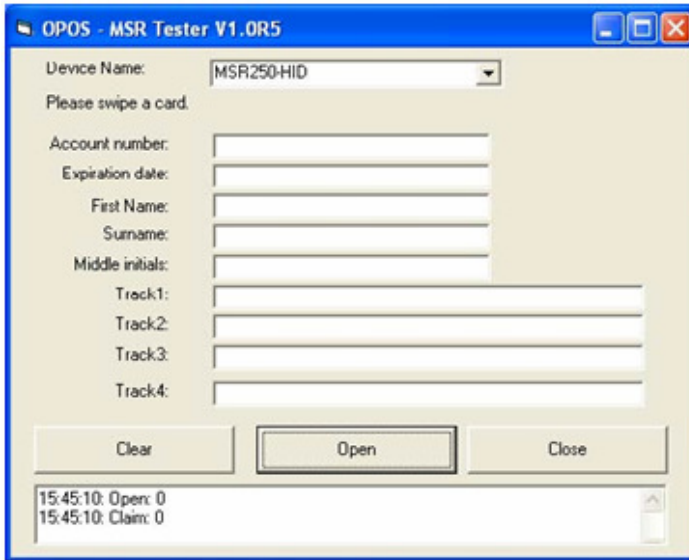

d.) Example 2. PROMAG MSR/MJR PART -NO, Keyboard mode

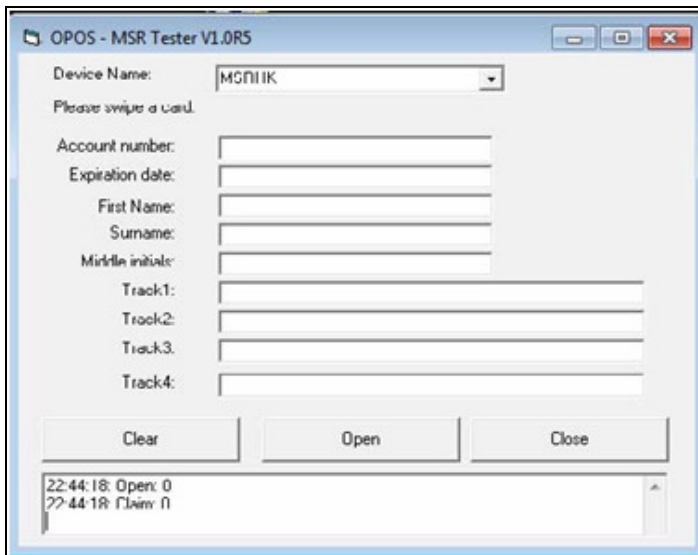

e.) Example 3. PROMAG MSR PART -NO, HID mode

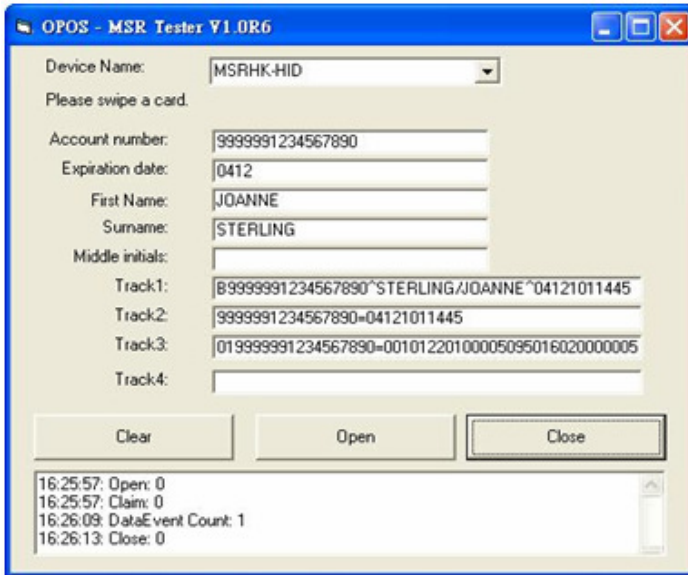

### 3-3. API

#### 3-3-1. API Package Content

You can find API Package files in the enclosed Manual/Driver CD. Depending on machine types, the API Package may include the following files.

Function DLL			
Directory	Function	File Name	Description
ProxAPI standard\	multilangXML.dll		Driver to open XML file
	Initial.xml		XML file to initiate the API Package
	ProxAP.exe		API program executable file
	XML Files\Model Name*\Initial.xml		XML file for each model
	Version.ini		Version information

Sample Program		
Directory	Contents / File Name	Description
DEMO PROJECT\	DEMO PROJECT\GPIO Sample Code	C# VB6 VB.net Source Code
	DEMO PROJECT\Digital Sample Code	C# VB6 VB.net Source Code

### 3-3-2. API Procedure

Take **VB2005 .NET** for example.

1. First you must declare a function. You may create a module in your project and fill in the function.

Example: Cash drawer

```
Declare Function GetCashDrawerStatus Lib CashDrawer.dll (ByVal num_drawer as short) As Boolean
```

```
Declare Function CashDrawerOpen Lib CashDrawer.dll (ByVal num_drawer as short) As Boolean
```

2. Then create a button to call API Function.

- a.) Call Cash drawer open event:

```
Private Sub cash_btn1_Click (ByVal Sender As System.Object, ByVal e As System.EventArgs) Handles cash_btn1.Click  
CashDrawerOpen(1), "1" specifies the cash drawer 1 port  
CashDrawerOpen(2), "2" specifies the cash drawer 2 port  
Timer1.start
```

- b.) Detect Cash drawer status:

A timer event can be created.

```
Private Sub Timer1_Tick (ByVal Sender As System.Object,ByVal e As System.EventArgs) Handles Timer1.Tick  
Dim Receive_Status1 as Boolean  
Dim Receive_Status2 as Boolean  
Receive_Status1 = CashDrawerOpen(&H1)  
If Receive_Status1 = true then  
Text1.text = "cash drawer1 open" 'enter text into textbox.  
Else
```

```
Text1.text = "cash drawer1 close" 'enter text into textbox.
End if
=====
    Receive_Status2 = CashDrawerOpen(&H2)
    If Receive_Status2 = true then
        Text2.text = "cash drawer2 open" 'enter text into textbox.
    Else
        Text2.text = "cash drawer2 close" 'enter text into textbox.
    End if
=====
End sub
```



### 3-3-3. Sample Code

1. VB Declaration Method

Declare Function GetCashDrawerStatus Lib CashDrawer.dll (ByVal num\_drawer as short) As Boolean

Declare Function CashDrawerOpen Lib CashDrawer.dll (ByVal num\_drawer as short) As Boolean

- Call Function

**Open cash drawer:**

CashDrawerOpen(1)

**Open cash drawer1**

CashDrawerOpen(2)

**Open cash drawer2**

**Check cash drawer status:**

Dim receive\_status as Boolean

**Check cash drawer1 status**

Receive\_Status = CashDrawerOpen(&H1)

**Check cash drawer2 status**

Receive\_Status = CashDrawerOpen(&H2)

## 2. C# Declaration Method

```
Public class PortAccess
{
[DllImport("CashDrawer.dll",EntryPoint = "Initial_CashDrawer")]
Public static extern void Initial_CashDrawer();
[DllImport("CashDrawer.dll",EntryPoint= "GetCashDrawerStatus")]
Public static extern bool GetCashDrawerStatus()
[DllImport("CashDrawer.dll",EntryPoint = "CashDrawerOpen")]
Public static extern bool CashDrawerOpen(short num_drawer);}
```

- Call Function

### **Open cash drawer1**

```
PortAccess.CashDrawerOpen(0x01); //check cash drawer1 status
```

### **Open cash drawer2**

```
PortAccess.CashDrawerOpen(0x02); //check cash drawer2 status
```

```
Bool bstatus;
```

```
bstatus = PortAccess.GetCashDrawerStatus(0x01);
```

```
bstatus = PortAccess.GetCashDrawerStatus(0x02); //Before get cash drawer status,  
need to initial cash drawer first
```

3. VB.NET extern function:

```
Declare Function Digital_Initial Lib "Digital.dll" ( ) As Long
Declare Function Digital_Set Lib "Digital.dll"(ByVal hex_value As Short) As Long
Declare Function Digital_Get Lib "Digital.dll" ( ) As Short
```

```
Declare Function GPIO_Initial Lib "GPIO.dll" ( ) As Long
Declare Function GPIO_SetPort Lib "GPIO.dll"(ByVal direct As long)
Declare Function GPIO_Set Lib "GPIO.dll"(ByVal dout_value As long) As Boolean
Declare Function GPIO_Get Lib "GPIO.dll"() As Short
```

```
Declare Function GetCashDrawerStatus Lib CashDrawer.dll (ByVal num_drawer as
short) As Boolean
Declare Function CashDrawerOpen Lib CashDrawer.dll (ByVal num_drawer as short)
As Boolean
```

4. VB 6 extern function:

```
Declare Function CashDrawerOpen Lib "CashDrawer.dll" (ByVal num_drawer As
Integer) As Boolean
Declare Function GetCashDrawerStatus Lib "CashDrawer.dll" (ByVal num_drawer
As Integer) As Boolean
```

**Note:** VB.net short = integer VB6

### 3-3-4. Cash Drawer

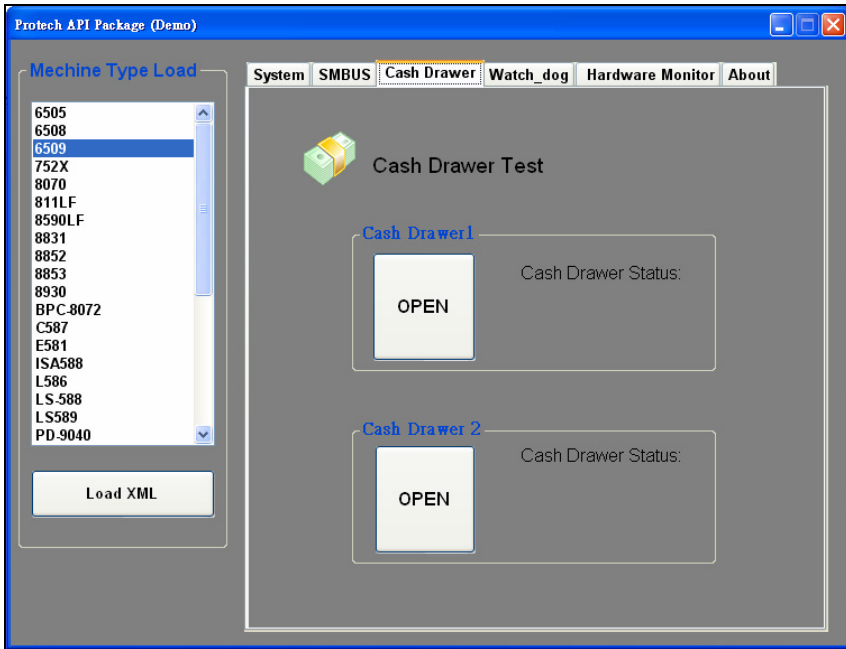

Button/Item	Description				
OPEN (button)	Tap to open the cash drawer.				
Cash Drawer Status	<p>Cash drawer status will be displayed after <b>OPEN</b> is tapped.</p> <ul style="list-style-type: none"> <li>Drawer is closed as shown:           <table border="1" data-bbox="793 1095 1007 1208"> <tr> <td>Cash Drawer Status:</td> </tr> <tr> <td style="text-align: center;"><b>Close</b></td> </tr> </table> </li> <li>Drawer is open as shown:           <table border="1" data-bbox="793 1229 1007 1333"> <tr> <td>Cash Drawer Status:</td> </tr> <tr> <td style="text-align: center;"><b>Open</b></td> </tr> </table> </li> </ul>	Cash Drawer Status:	<b>Close</b>	Cash Drawer Status:	<b>Open</b>
Cash Drawer Status:					
<b>Close</b>					
Cash Drawer Status:					
<b>Open</b>					

### **3-3-7. API Function**

The API program-related sample programs, developed in VB.Net and C#, are provided for easy use of the API Package. Refer to the main API functions listed as below.

<b>API Function</b>		<b>DLL</b>	
<b>Cash Drawer</b>	CashDrawerOpen	multilangXML.dll	CashDrawer.dll
	GetCashDrawerStatus		

### 3-3-8. Cash Drawer Function

<b>CashDrawerOpen</b>
-----------------------

```
bool CashDrawerOpen (short num_drawer);
```

Purpose: Open the cash drawer API.  
Value: num\_drawer = 1 (Open the Cash Drawer1)  
num\_drawer = 2 (Open the Cash Drawer2)  
Return: True (1) on success, False (0) on failure

Example: CashDrawerOpen(0x01); // Open the Cash Drawer1

<b>GetCashDrawerStatus</b>
----------------------------

```
bool GetCashDrawerStatus (short num_drawer);
```

Purpose: Get the cash drawer status.  
Value: num\_drawer = 1 (Get the Cash Drawer1 status)  
num\_drawer = 2 (Get the Cash Drawer2 status)  
Return: True (1) on success, False (0) on failure

Example: Short data;  
data= GetCashDrawerStatus(0x01); // Get the Cash Drawer1 status  
if (data)  
MsgBox("open1"); // Cash Drawer1 status "Open"  
Else  
MsgBox("close1"); // Cash Drawer1 status "Close"  
Endif

## 3-4. BIOS Operation

### 3-4-1. Introduction

The board PA-6225 uses an AMI Aptio BIOS that is stored in the Serial Peripheral Interface Flash Memory (SPI Flash) and can be updated. The SPI Flash contains the BIOS Setup program, Power-on Self-Test (POST), the PCI auto-configuration utility, LAN EEPROM information, and Plug and Play support.

Aptio is AMI's BIOS firmware based on the UEFI (Unified Extensible Firmware Interface) Specifications and the Intel Platform Innovation Framework for EFI. The UEFI specification defines an interface between an operating system and platform firmware. The interface consists of data tables that contain platform-related information, boot service calls, and runtime service calls that are available to the operating system and its loader. These provide standard environment for booting an operating system and running pre-boot applications. Following illustration shows Extensible Firmware Interface's position in the software stack.

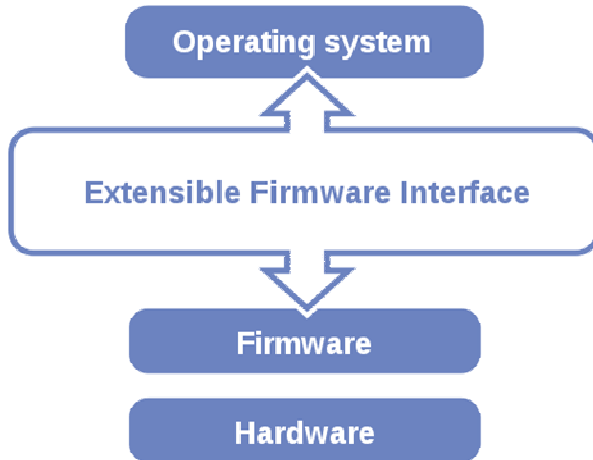

EFI BIOS provides an user interface allow users the ability to modify hardware configuration, e.g. change system date and time, enable or disable a system component, decide bootable device priorities, setup personal password, etc., which is convenient for modifications and customization of the computer system and allows technicians another method for finding solutions if hardware has any problems.

The BIOS Setup program can be used to view and change the BIOS settings for the computer. The BIOS Setup program is accessed by pressing the <Del> or <ESC> key after the POST memory test begins and before the operating system boot begins. The settings are shown below.



### **3-4-2. Entering Setup**

When the system is powered on, the BIOS will enter the Power-On Self Test (POST) routines and the following message will appear on the lower screen:



**POST screen**

As long as this message is present on the screen you may press the <Del> key (the one that shares the decimal point at the bottom of the number keypad) to access the Setup program. In a moment, the main menu of the Aptio Setup Utility will appear on the screen:

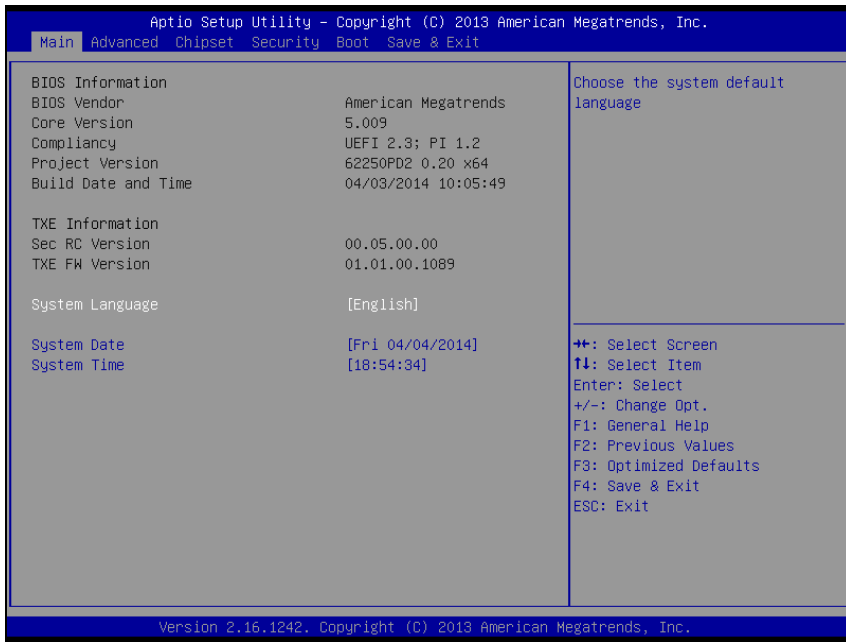
**BIOS setup program initial screen**

You may move the cursor by up/down keys to highlight the individual menu items. As you highlight each item, a brief description of the highlighted selection will appear at the bottom of the screen.

## 3-4-3. Main

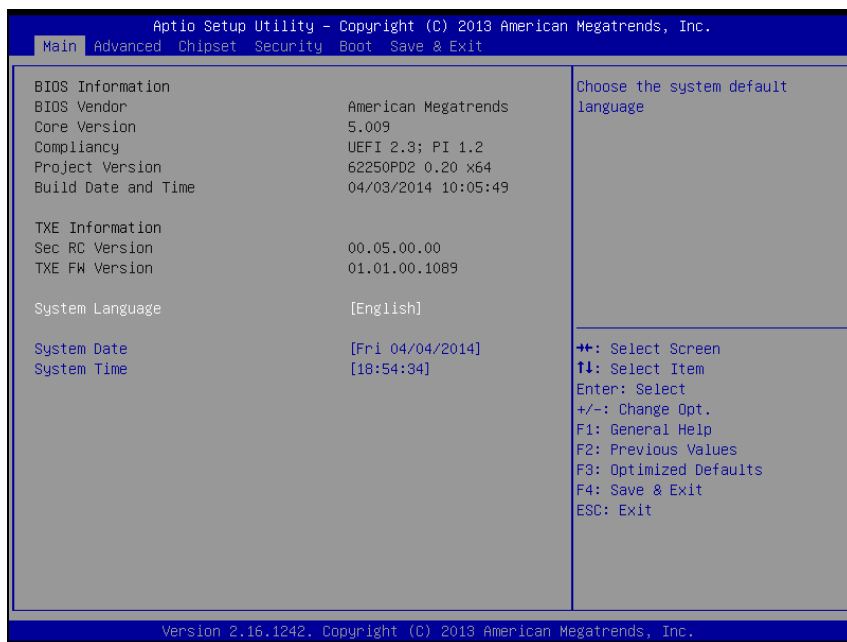

Main screen

BIOS Setting	Options	Description/Purpose
BIOS Vendor	No changeable options	Displays the BIOS vendor.
Core Version	No changeable options	Displays the current BIOS core version.
Compliance	No changeable options	Displays the current UEFI version.
Project Version	No changeable options	Displays the version of the BIOS currently installed on the platform.
Build Date and Time	No changeable options	Displays the date of current BIOS version.
Sec RC Version	No changeable options	Displays the current Sec RC version.
TXE FW Version	No changeable options	Displays the current TXE Version

<b>BIOS Setting</b>	<b>Options</b>	<b>Description/Purpose</b>
System Language	English	BIOS Setup language.
System Date	month, day, year	Specifies the current date.
System Time	hour, minute, second	Specifies the current time.

## 3-4-4. Advanced

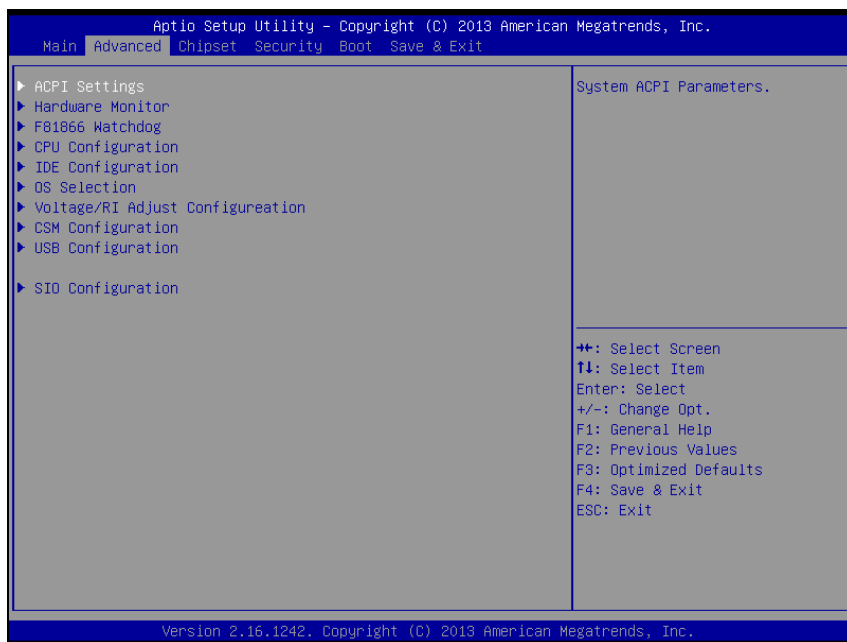

Advanced screen

BIOS Setting	Options	Description/Purpose
ACPI Settings	Sub-Menu	System ACPI Parameters.
Hardware Monitor	Sub-Menu	Monitor hardware status
F81866 Watchdog	Sub-Menu	F81866 Watchdog Parameters.
CPU Configuration	Sub-Menu	CPU Configuration. Parameters.
IDE Configuration	Sub-Menu	SATA Configuration Parameters.
OS Selection	Sub-Menu	OS Selection
Voltage/RI Adjust Configuration	Sub-Menu	Voltage/RI Adjust settings.
CSM Configuration	Sub-Menu	Configure Option ROM execution, boot options filters, etc..
USB Configuration	Sub-Menu	USB Configuration Parameters.
SIO Configuration	Sub-Menu	System Super IO Chip Configuration.

## 3-4-4-1. ACPI Settings

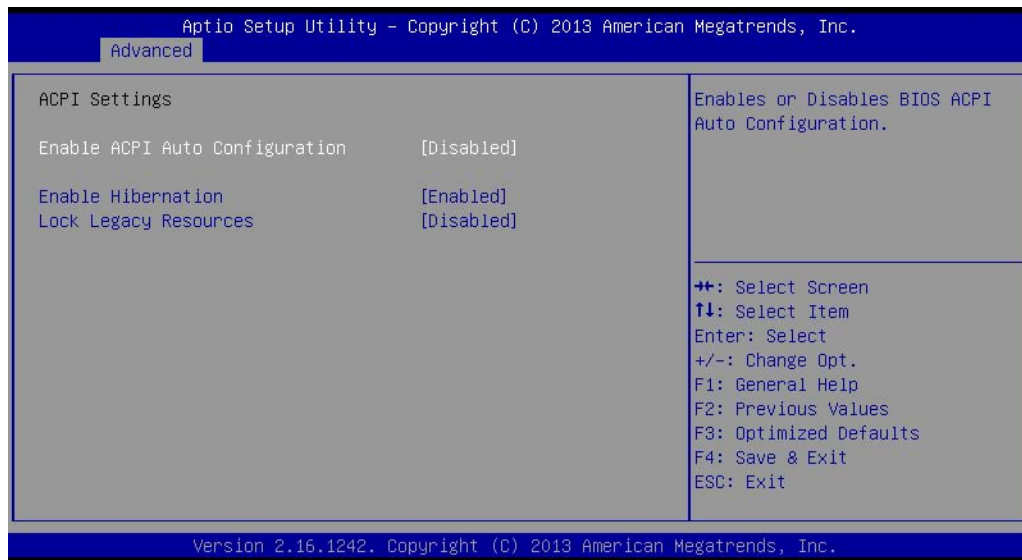

ACPI Settings screen

BIOS Setting	Options	Description/Purpose
Enable ACPI Auto Configuration	- Disabled - Enabled	Enables or Disables ACPI feature.
Enable Hibernation	- Disabled - Enabled	Enables or Disables System ability to Hibernate (OS/S4 Sleep State). This option may be not effective with some OS.
Lock Legacy Resources.	- Disabled - Enabled	Enables or Disables Lock of Legacy Resources.

## 3-4-4-2. Hardware Monitor

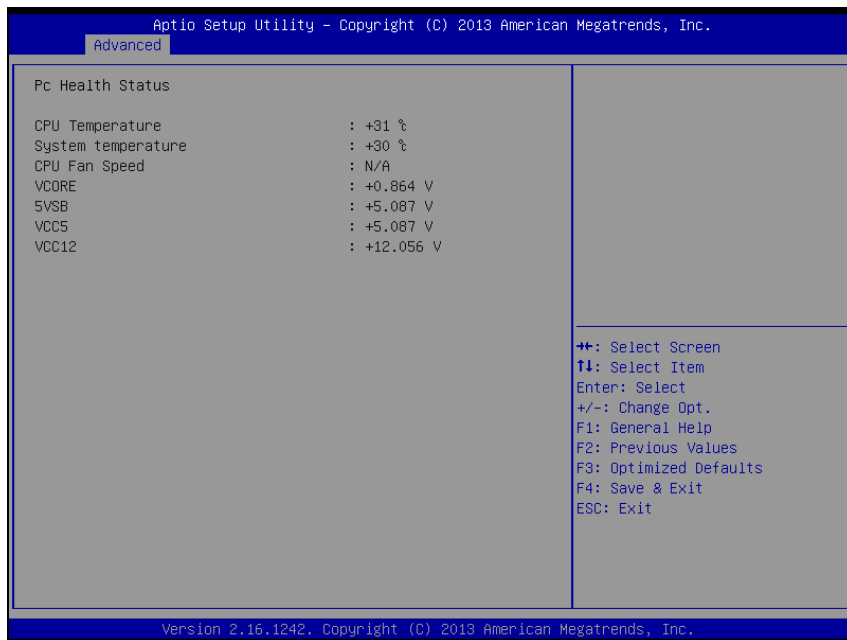

Hardware Monitor screen

BIOS Setting	Options	Description/Purpose
CPU Temperature	No changeable options	Displays processor's temperature.
System Temperature	No changeable options	Displays system's temperature
CPU Fan Speed	No changeable options	Displays Fan's speed
VCORE	No changeable options	Displays voltage level of the +VCORE in supply.
5VSB	No changeable options	Displays voltage level of the +VSB5 in supply.
VCC5	No changeable options	Displays voltage level of the + VCC5 in supply.
VCC12	No changeable options	Displays voltage level of the + VCC12 in supply.

## 3-4-4-3. F81866 Watchdog

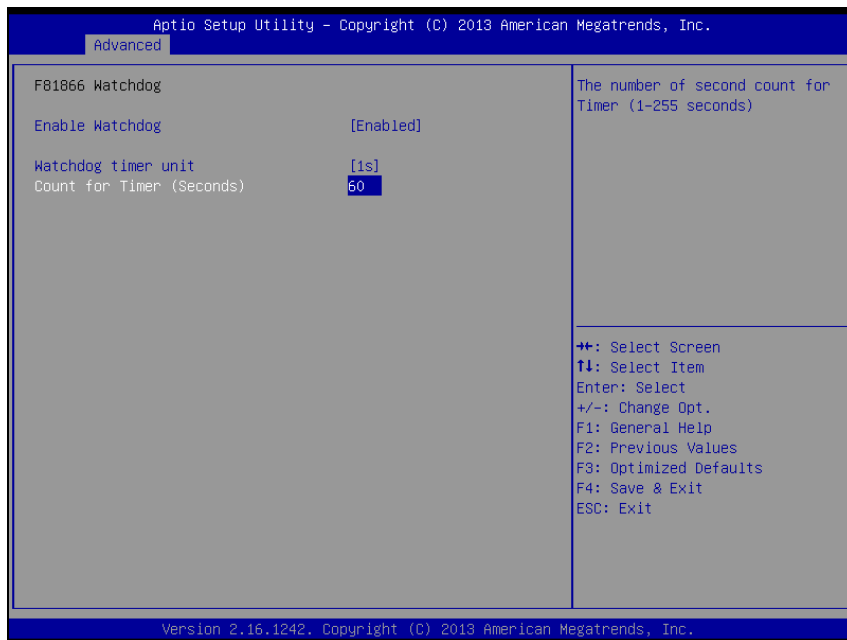

F81866 Watchdog screen

BIOS Setting	Options	Description/Purpose
Enable WatchDog	-Enabled -Disable	Enable/ Disable Watch dog timer.
Watchdog timer unit	-1s -60s	Select seconds or minutes
Count for Timer (Seconds)	Multiple options ranging from 1 to 255	Sets the desired value (seconds) for watchdog timer.



## 3-4-4-4. CPU Configuration

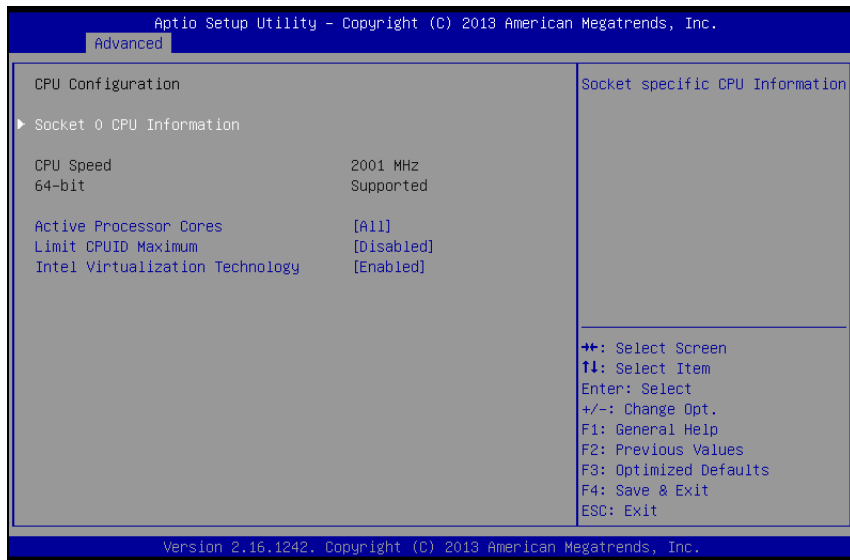

CPU Configuration screen

BIOS Setting	Options	Description/Purpose
CPU Signature	No changeable options	Reports the CPU Signature
Socket 0 CPU Information	Sub-Menu	Report CPU Information
CPU Speed	No changeable options	Reports the current CPU Speed
64-bit	No changeable options	Reports if 64-bit is supported by processor.
Active Processor Cores	- All - 1	Choose the number of cores to be enabled in current processor.
Limit CPUID Maximum	- Disabled - Enabled	Enables for legacy operating systems to boot processors with extended CPUID functions. Set disable for WinXP.
Intel Virtualization Technology	- Disabled - Enabled	When enabled, a VMM can utilize the additional hardware capabilities provided by Vanderpool Technology (VT).

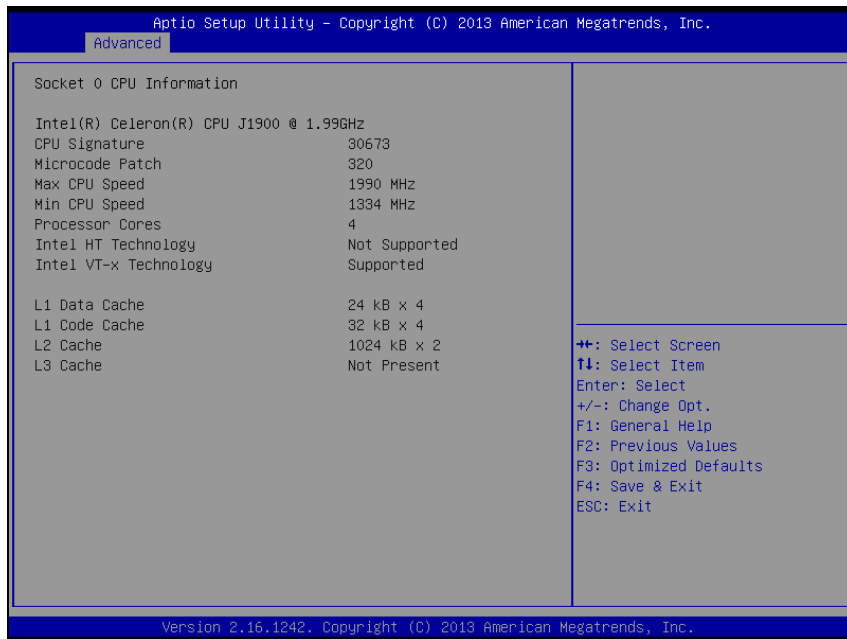

Socket 0 CPU Information screen

BIOS Setting	Options	Description/Purpose
CPU Signature	No changeable options	Reports the CPU Signature
Microcode Patch	No changeable options	Reports the CPU Microcode Patch Version.
Max CPU Speed	No changeable options	Reports the maximum CPU Speed.
Min CPU Speed	No changeable options	Reports the minimum CPU Speed
Processor Cores	No changeable options	Displays number of physical cores in processor.
Intel HT Technology	No changeable options	Reports if Intel Hyper-Threading Technology is supported by processor
Intel VT-x Technology	No changeable options	Reports if Intel VT-x Technology is supported by processor.
L1 Data Cache	No changeable options	Displays size of L1 Data Cache
L1 Code Cache	No changeable options	Displays size of L1 Code Cache
L2 Cache	No changeable options	Displays size of L2 Cache.
L3 Cache	No changeable options	Displays size of L3 Cache.

## 3-4-4-5. IDE Configuration

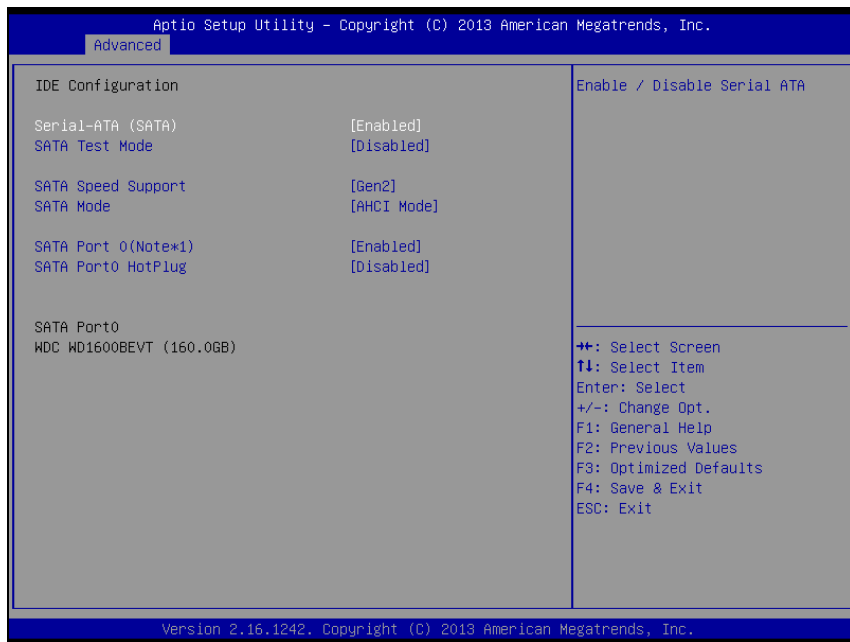

IDE Configuration screen

BIOS Setting	Options	Description/Purpose
Serial-ATA Controller(s)	- Disabled - Enabled	Enable or disable SATA Device.
SATA Test Mode	- Disabled - Enabled	Enable or disable SATA Test Mode.
SATA Speed Support	- GEN1 - GEN2	<ul style="list-style-type: none"> <li>▪ <b>Gen1</b> mode sets the device to 1.5 Gbit/s speed.</li> <li>▪ <b>Gen2</b> mode sets the device to 3 Gbit/s speed (in case it is compatible).</li> </ul>
SATA Mode	- IDE mode - AHCI mode	Configures SATA as following: <ul style="list-style-type: none"> <li>▪ <b>IDE:</b> Set SATA operation mode to IDE mode.</li> <li>▪ <b>AHCI:</b> SATA works as AHCI (Advanced Host Controller Interface) mode for getting better performance.</li> </ul>

<b>BIOS Setting</b>	<b>Options</b>	<b>Description/Purpose</b>
SATA Port 0 (Note*1)	- Disabled - Enabled	Enable or disable SATA port 0 Device.
SATA Port 0 HotPlug	- Disabled - Enabled	Enable or disable SATA port 0 Device HotPlug
SATA Port 0	- [drive]	Displays the drive installed on this SATA port 0. Shows [Empty] if no drive is installed. If mother board support RAID that will show ASMT109x- Conf (0.1GB)

3-4-4-6. OS Selection

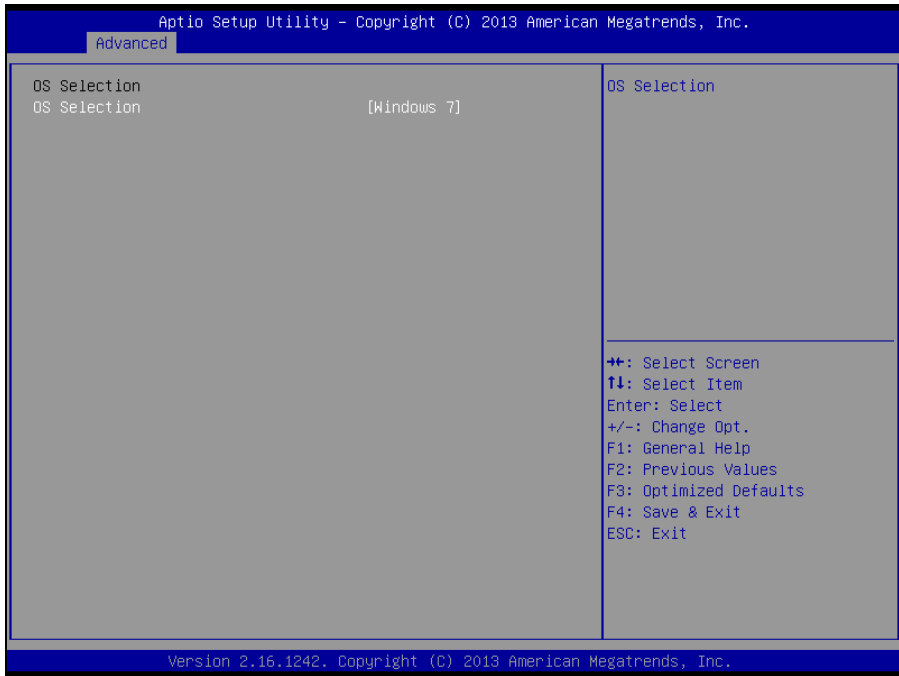

OS Selection screen

BIOS Setting	Options	Description/Purpose
OS Selection	- Windows 8.x - Windows7	Operation System Selection

3-4-4-7. Voltage/RI Adjust Configuration

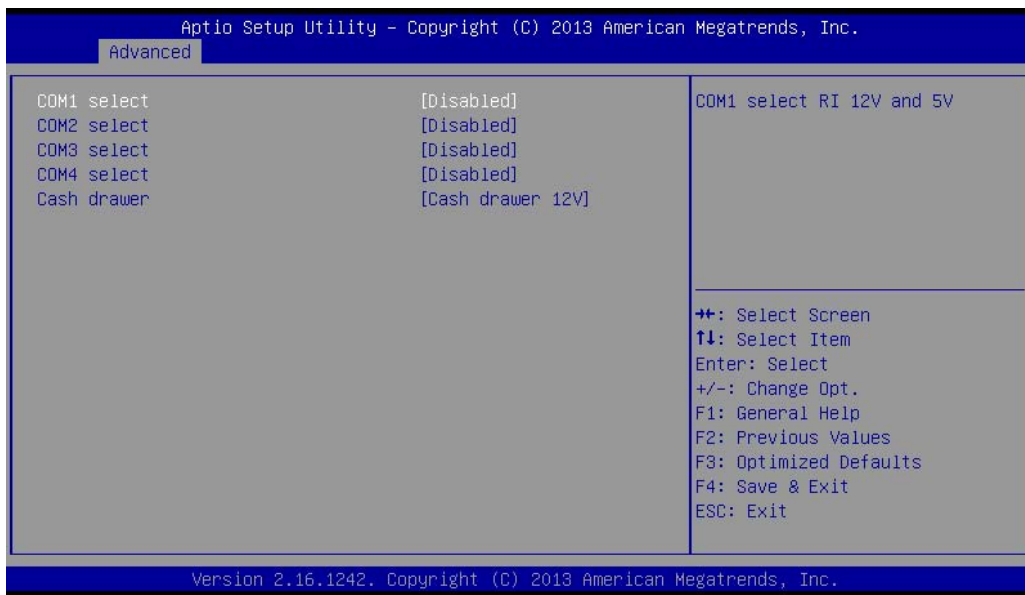

OS Selection screen

BIOS Setting	Options	Description/Purpose
COM1 Select	- Disabled -12V -5V	Select COM1 Port voltage.
COM2 Select	- Disabled -12V -5V	Select COM2 Port voltage.
COM3 Select	- Disabled -12V -5V	Select COM3 Port voltage.
COM4 Select	- Disabled -12V -5V	Select COM4 Port voltage.

BIOS Setting	Options	Description/Purpose
Cash drawer	- Cash drawer 12V - Cash drawer 24V	Select Cash drawer voltage.



OS Selection screen

## 3-4-4-8. CSM Configuration

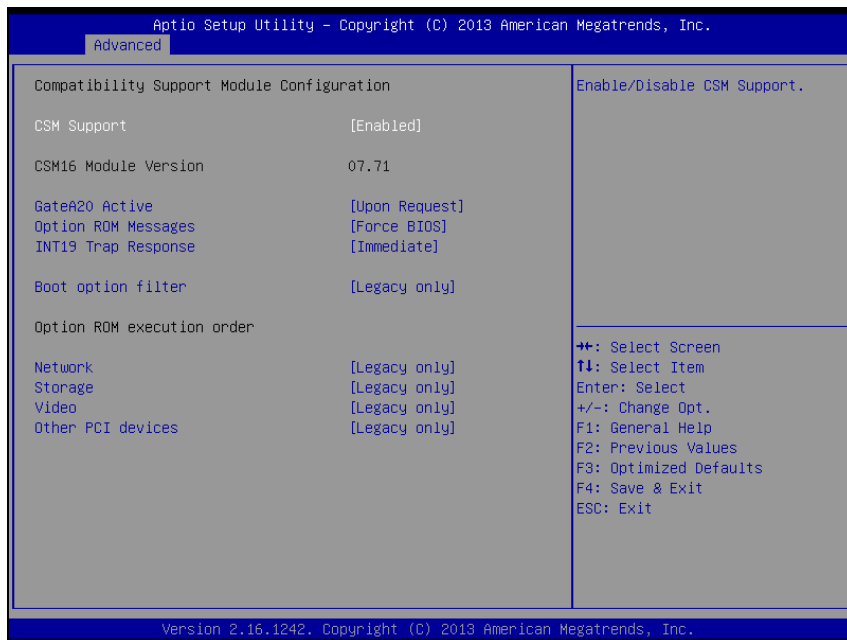

CSM Configuration screen

BIOS Setting	Options	Description/Purpose
CSM Support	- Disabled - Enabled	Disable or Enable CSM support
CSM16 Module Version	No changeable options	Displays the current CSM (Compatibility Support Module) version.
GateA20 Active	- Upon Request - Always	Select Gate A20 operation mode. <ul style="list-style-type: none"> <li>▪ <b>Upon Request:</b> GA20 can be disabled using BIOS services.</li> <li>▪ <b>Always:</b> do not allow disabling GA20; this option is useful when any RT code is executed above 1MB.</li> </ul>



BIOS Setting	Options	Description/Purpose
Option ROM Messages	- Force BIOS - Keep Current	Set display mode for Option ROM messages.
INT19 Trap Response	- Immediate - Postponed	BIOS reaction on INT19 trapping by Option ROM. <ul style="list-style-type: none"> <li>▪ <b>Immediate:</b> Execute the trap right away.</li> <li>▪ <b>Postponed:</b> Execute the trap during legacy boot.</li> </ul>
Boot option filter	- UEFI and Legacy - Legacy only - UEFI only	This option controls what kind of devices system can boot.
Network	- Do not launch - UEFI only - Legacy only - Legacy first - UEFI first	Controls the execution of UEFI or Legacy PXE
Storage	- Do not launch - UEFI only - Legacy only - Legacy first - UEFI first	Controls the execution of UEFI or Legacy Storage
Video	- Do not launch - UEFI only - Legacy only - Legacy first - UEFI first	Controls the execution of UEFI and Legacy Video.
Other PCI devices	- UEFI first - Legacy only	Select launch method for other PCI devices, such as NIC, mass storage or video card.

## 3-4-4-9. USB Configuration

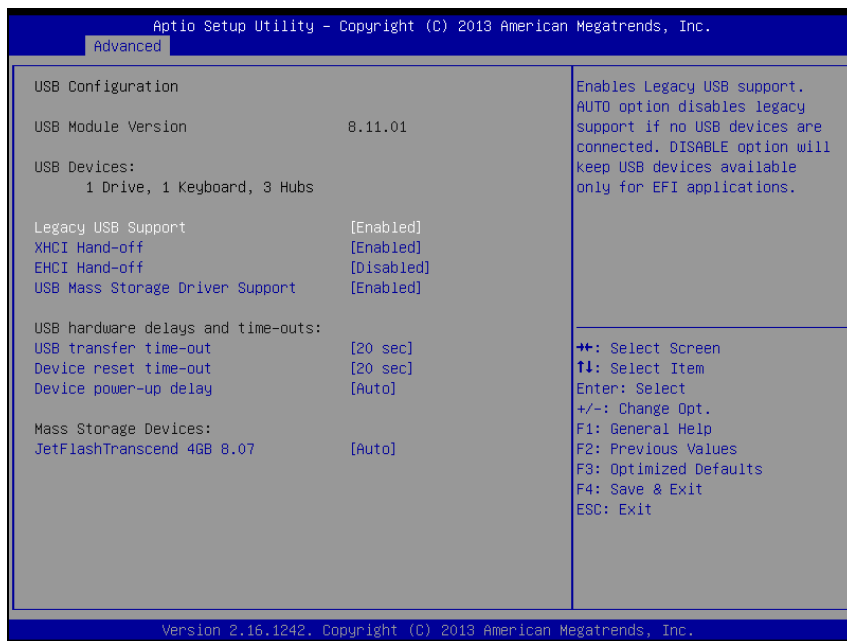

USB Configuration screen

BIOS Setting	Options	Description/Purpose
USB Devices	No changeable options	Displays number of available USB devices.
Legacy USB Support	- Disabled - Enabled - Auto	Enables support for legacy USB.
USB3.0 Support	- Disabled - Enabled	Enable/Disable USB3.0 (XHCI) Controller support.
EHCI Hand-of	- Disabled - Enabled	This is a workaround for OSes w/o EHCI hand-off support.
USB Mass Storage Driver Support	- Disabled - Enabled	Enable/Disable USB mass storage driver support.

<b>BIOS Setting</b>	<b>Options</b>	<b>Description/Purpose</b>
USB transfer time-out	1 / 5 / 10 /20 sec	The time-out value for Control, Bulk, and Interrupt transfers.
Device reset time-out	10 / 20 / 30 / 40 sec	USB mass storage device Start Unit command time-out.
Device power-up delay	- Auto - Manual	Maximum time the device will take before it properly reports itself to the Host Controller. "Auto" uses default value: for a Root port it is 100 ms, for a Hub port the delay is taken from Hub descriptor.
Device power-up delay in seconds	Multiple options ranging from 0 to 40	Delay range is 1..40 seconds, in one second increments
Mass Storage Devices:	- Auto - Floppy - Force FDD - Hard Disk - CD-ROM	Display the device name and choose the device emulation type.

## 3-4-4-10. Super IO Configuration

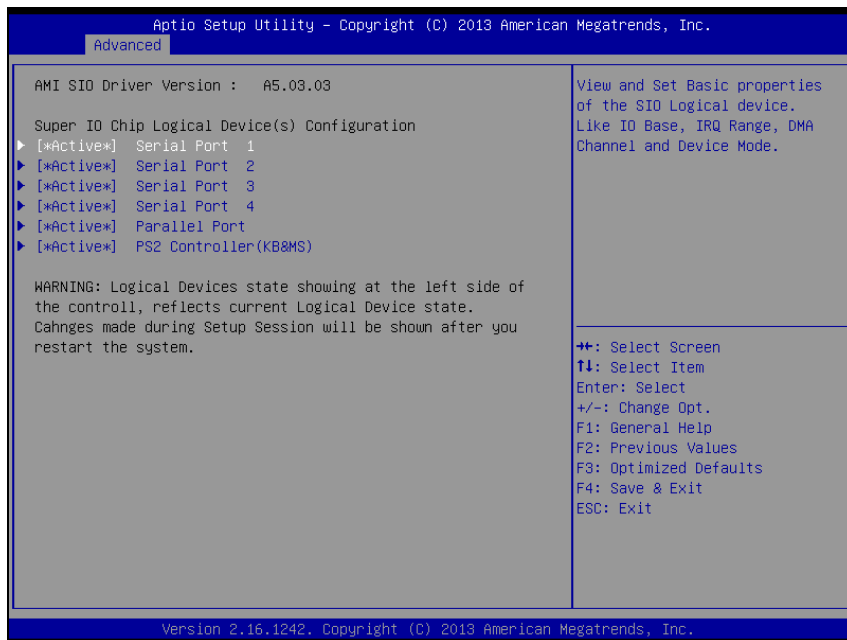

Super IO Configuration screen

BIOS Setting	Options	Description/Purpose
[*Active*] Serial Port 1	Sub-menu	Set Parameters for COM1
[*Active*] Serial Port 2	Sub-menu	Set Parameters for COM2
[*Active*] Serial Port 3	Sub-menu	Set Parameters for COM3
[*Active*] Serial Port 4	Sub-menu	Set Parameters for COM4
[*Active*] Parallel Port	Sub-menu	Set Parameters for LPT port.
[*Active*] PS2 Controller (KB&MS)	Sub-menu	Set Parameters for PS2.

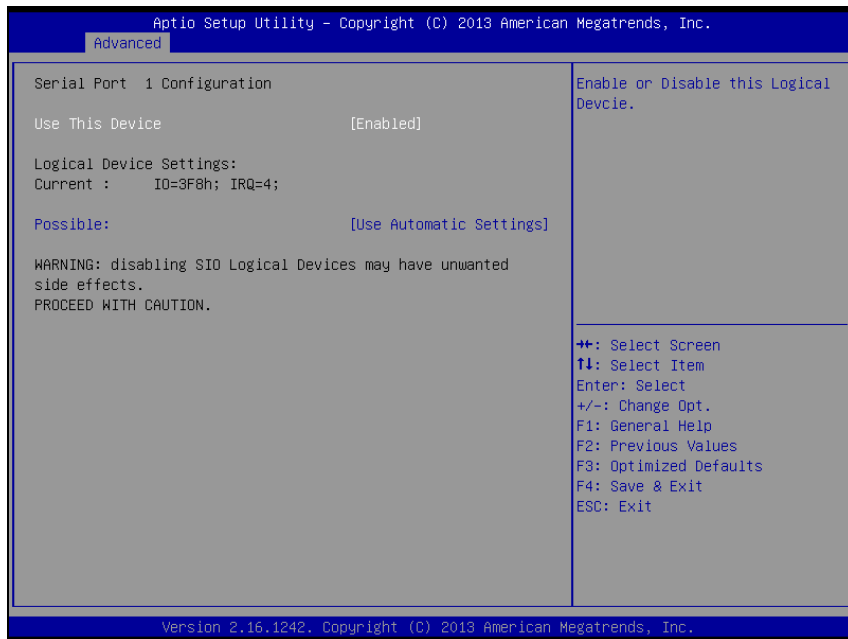

Serial Port 1 Configuration screen

BIOS Setting	Options	Description/ Purpose
Use This Device	- Disabled - Enabled	Enable or disable serial port 1.
Logical device setting	No changeable options	Displays current settings of serial port 2.
Possible:	- Use Automatic Settings - IO=3F8h; IRQ=4 DMA - IO=3F8h; IRQ=3,4,5,6,7,9,10,11,12 DMA - IO=2F8h; IRQ=3,4,5,6,7,9,10,11,12 DMA - IO=3E8h; IRQ=3,4,5,6,7,9,10,11,12 DMA - IO=2E8h; IRQ=3,4,5,6,7,9,10,11,12 DMA	Select IRQ and I/O resource for the serial port 1.

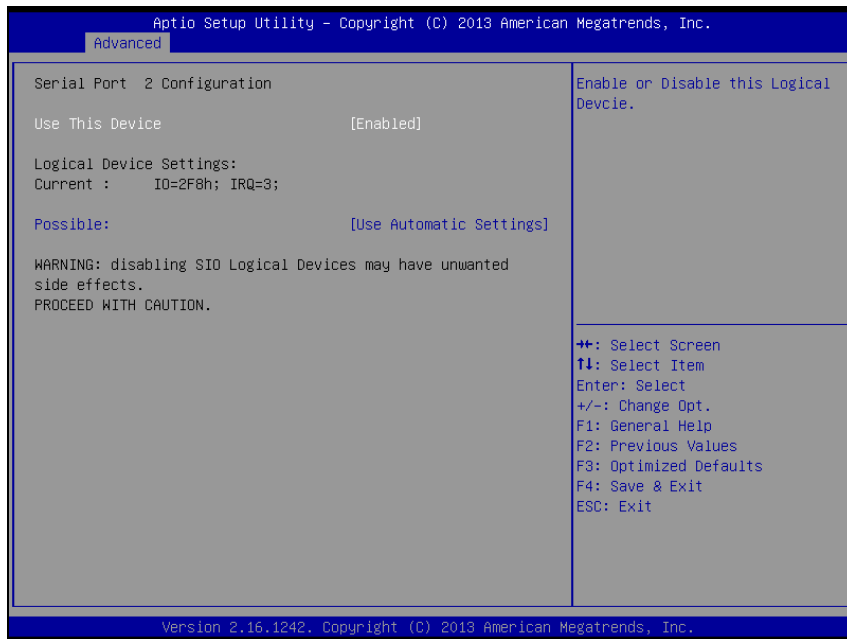

Serial Port 2 Configuration screen

BIOS Setting	Options	Description/ Purpose
Use This Device	-Disabled -Enabled	Enable or disable serial port 2.
Logical device setting	No changeable options	Displays current settings of serial port 2.
Possible:	-Use Automatic Settings -IO=2F8h; IRQ=3 DMA -IO=3F8h; IRQ=3,4,5,6,7,9,10,11,12 DMA -IO=2F8h; IRQ=3,4,5,6,7,9,10,11,12 DMA -IO=3E8h; IRQ=3,4,5,6,7,9,10,11,12 DMA -IO=2E8h; IRQ=3,4,5,6,7,10,11,12 DMA	Select IRQ and I/O resource for the serial port 2

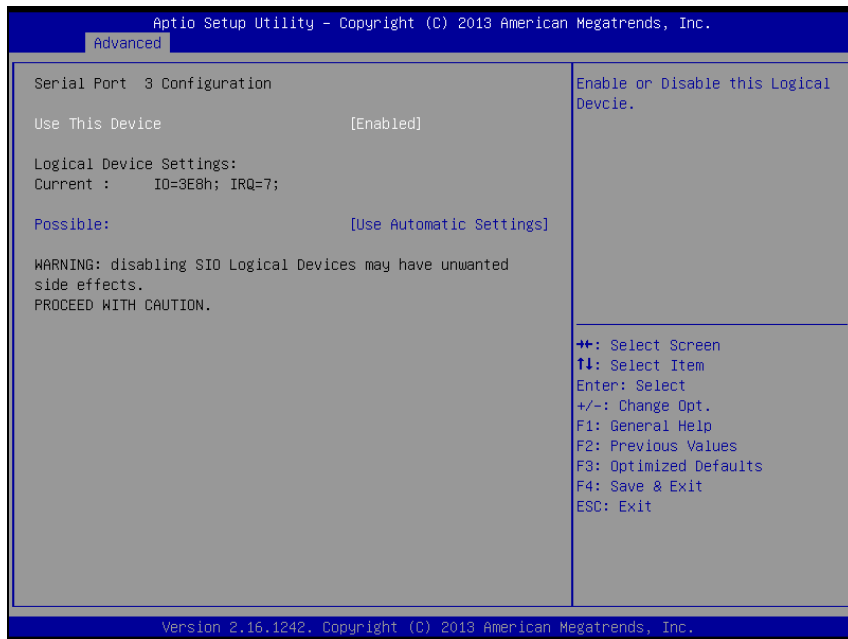

Serial Port 3 Configuration screen

BIOS Setting	Options	Description/ Purpose
Use This Device	- Disabled - Enabled	Enable or disable serial port 3.
Logical device setting Current	No changeable options	Displays current settings of serial port 3.
Possible:	- Use Automatic Settings - IO=3E8h; IRQ=7 DMA - IO=3F8h; IRQ=3,4,5,6,7,9,10,11,12 DMA - IO=2F8h; IRQ=3,4,5,6,7,9,10,11,12 DMA - IO=3E8h; IRQ=3,4,5,6,7,9,10,11,12 DMA - IO=2E8h; IRQ=3,4,5,6,7,9,10,11,12 DMA - IO=2F0h; IRQ=3,4,5,6,7,9,10,11,12 DMA - IO=2E0h; IRQ=3,4,5,6,7,9,10,11,12 DMA	Select IRQ and I/O resource for the serial port 3

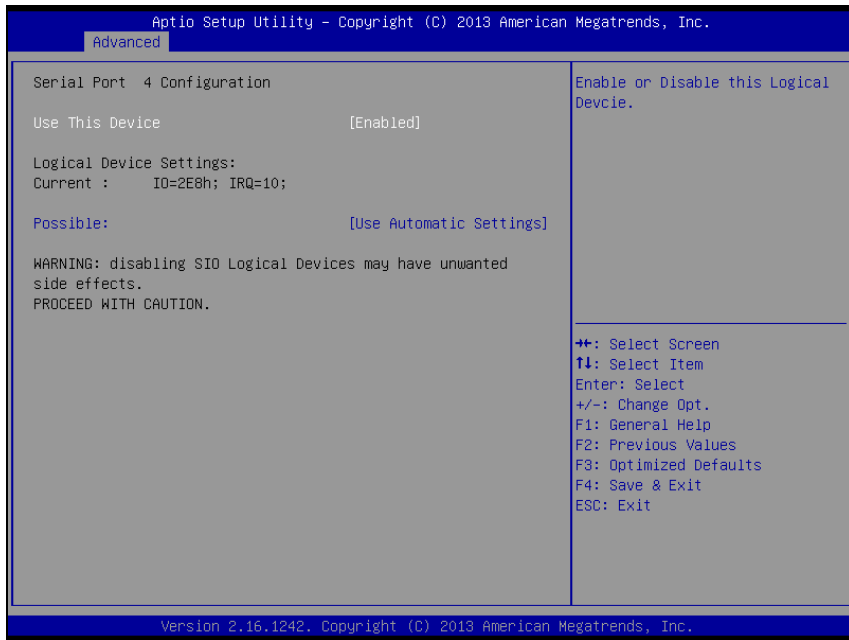

Serial Port 4 Configuration screen

BIOS Setting	Options	Description/ Purpose
Use This Device	-Disabled -Enabled	Enable or disable serial port 4.
Logical device setting Current	No changeable options	Displays current settings of serial port 4.
Possible:	- Use Automatic Settings - IO=2E8h; IRQ=7 DMA - IO=3F8h; IRQ=3,4,5,6,7,9,10,11,12 DMA - IO=2F8h; IRQ=3,4,5,6,7,9,10,11,12 DMA - IO=3E8h; IRQ=3,4,5,6,7,9,10,11,12 DMA - IO=2E8h; IRQ=3,4,5,6,7,9,10,11,12 DMA - IO=2F0h; IRQ=3,4,5,6,7,9,10,11,12 DMA - IO=2E0h; IRQ=3,4,5,6,7,9,10,11,12 DMA	Select IRQ and I/O resource for the serial port 4



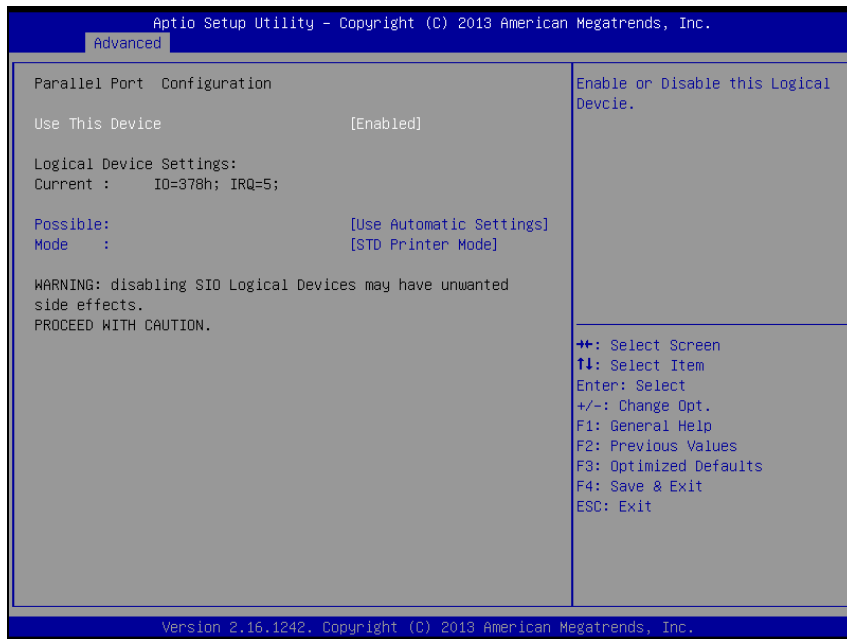

Parallel Port Configuration screen

BIOS Setting	Options	Description/Purpose
User This Device	- Disabled - Enabled	Enable or disable the printer port.
Logical device setting Current	No changeable options	Displays current settings of the printer port.
Possible:	- Use Automatic Settings -IO=378h; IRQ=5 -IO=378h; IRQ=5,6,7,9,10,11,12 -IO=278h; IRQ=5,6,7,9,10,11,12 -IO=3BCh; IRQ=5,6,7,9,10,11,12	Select IRQ and I/O resource for the printer port.

BIOS Setting	Options	Description/Purpose
Mode	- STD Printer Mode - SPP Mode - EPP-1.9 and SPP Mode - EPP-1.7 and SPP Mode - ECP Mode - ECP and EPP 1.9 Mode - ECP and EPP 1.7 Mode	Selects the mode for the parallel port. Not available if the parallel port is disabled. <ul style="list-style-type: none"><li>▪ <b>SPP</b> is Standard Parallel Port mode, a bi-directional mode for printers.</li><li>▪ <b>EPP</b> is Enhanced Parallel Port mode, a high-speed bi-directional mode for non-printer peripherals.</li><li>▪ <b>ECP</b> is Enhanced Capability Port mode, a high-speed bi-directional mode for printers and scanners.</li></ul>

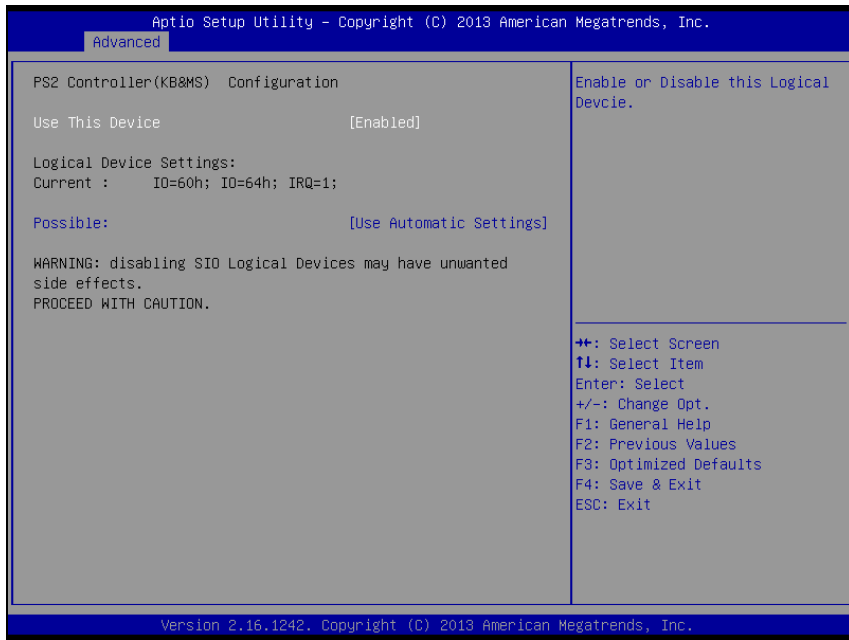

**PS2 Controller (KB & MS) Configuration screen**

BIOS Setting	Options	Description/Purpose
Use This Device	-Disabled -Enabled	Enable or disable the PS2.
Logical device setting Current	No changeable options	Displays current settings of the printer port.
Possible:	- Use Automatic Settings -IO=60h; IO=60h; IRQ=1	Select IRQ and I/O resource for the printer port.

## 3-4-5. Chipset

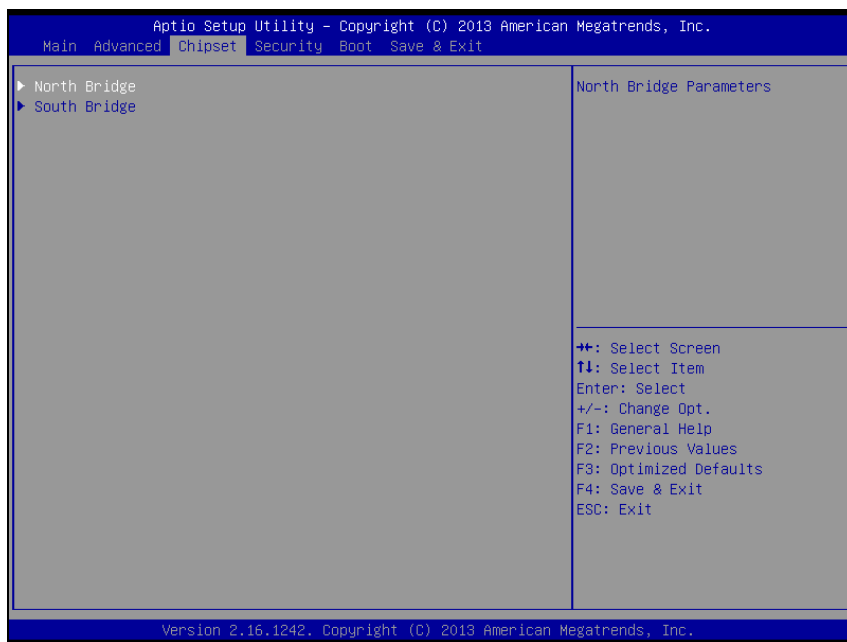

Chipset screen

BIOS Setting	Options	Description/Purpose
North Bridge	Sub-menu	Sets Parameter for (North Bridge) configuration.
South Bridge	Sub-menu	Sets Parameter for (South Bridge) configuration.

## 3-4-5-1. North Bridge

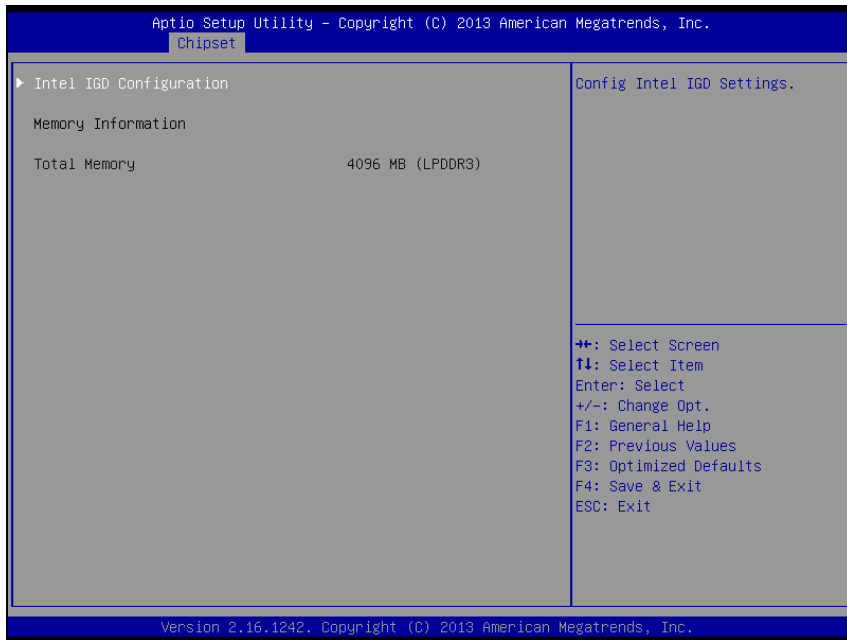

North Bridge screen

BIOS Setting	Options	Description/Purpose
Intel IGD Configuration	Sub-menu	Configure Graphic Settings.
Memory Information	No changeable options	Displays the DRAM information on platform.
Total Memory	No changeable options	Displays the DRAM size

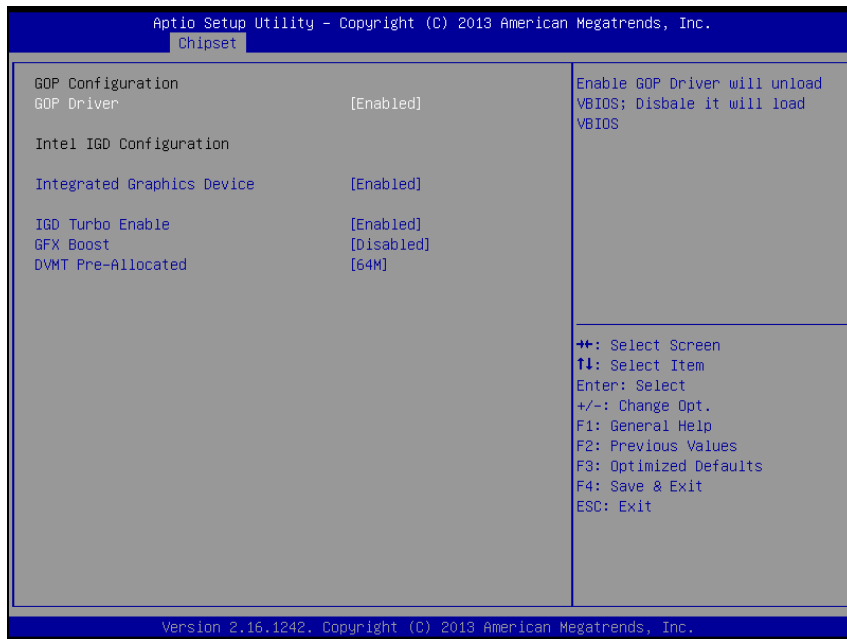

Intel IGD Configuration screen

BIOS Setting	Options	Description/Purpose
GOP Driver	- Disabled - Enabled	Enable or disable GOP Driver for UEFI OS
Intel IGD Configuration	No changeable options	Displays the IGD information on platform.
Integrated Graphics Device	- Disabled - Enabled	<ul style="list-style-type: none"> <li>▪ <b>Enabled:</b> Enable Integrated Graphics Device (IGD) when selected as the Primary Video Adaptor.</li> <li>▪ <b>Disabled:</b> Always disable IGD"</li> </ul>
IGD Turbo Enable	- Disabled - Enabled	Enable or disable IGD Turbo
GFX Boost	- Disabled - Enabled	Enable or disable GFX Boost accelerated graphics processing

<b>BIOS Setting</b>	<b>Options</b>	<b>Description/Purpose</b>
DVMT Pre-Allocated	- 32M - 64M - 96M - 128M - 256M - 512M	Select DVMT 5.0 Pre-Allocated (Fixed) Graphics Memory size used by the Internal Graphics Device.

## 3-4-5-2. South Bridge

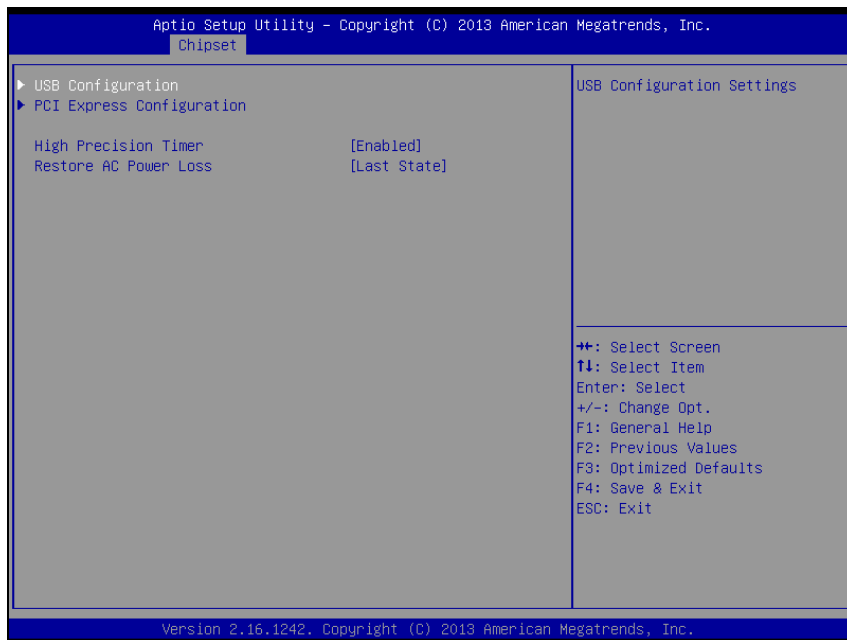

South Bridge screen

BIOS Setting	Options	Description/Purpose
USB Configuration	Sub-menu	Configure USB parameters.
PCI Express Configuration	Sub-menu	Configure PCH PCIE parameters
High Precision Timer	- Disabled - Enabled	Enable or disable the HPET (High Precision Event Timer)
Restore AC Power Loss	- Power Off - Power On - Last State	Select AC power state when power is re-applied after a power failure. <ul style="list-style-type: none"> <li>▪ <b>Power Off</b> keeps power off till the power button is pressed.</li> <li>▪ <b>Power On</b> makes system power on after system restores AC power to the board.</li> <li>▪ <b>Last State</b> brings system back to the last power state before AC remove.</li> </ul>



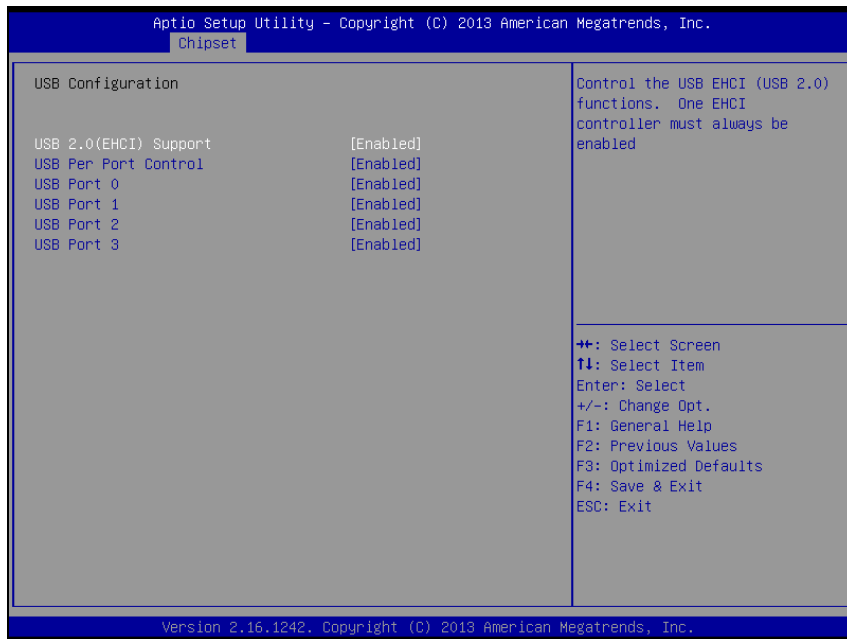

USB Configuration screen

BIOS Setting	Options	Description/Purpose
USB 2.0 (EHCI) Support	- Disabled - Enabled	(XHCI Mode need set disabled.) Enables Enhanced Host Controller Interface 1 for high-speed USB functions (USB 2.0).
USB Per Port Control	- Disabled - Enabled	Enabled or Disabled per USB port
USB Port 0	- Disabled - Enabled	Enabled or Disabled USB port 0
USB Port 1	- Disabled - Enabled	Enabled or Disabled USB port 1
USB Port 2	- Disabled - Enabled	Enabled or Disabled USB port 2
USB Port 3	- Disabled - Enabled	Enabled or Disabled USB port 3

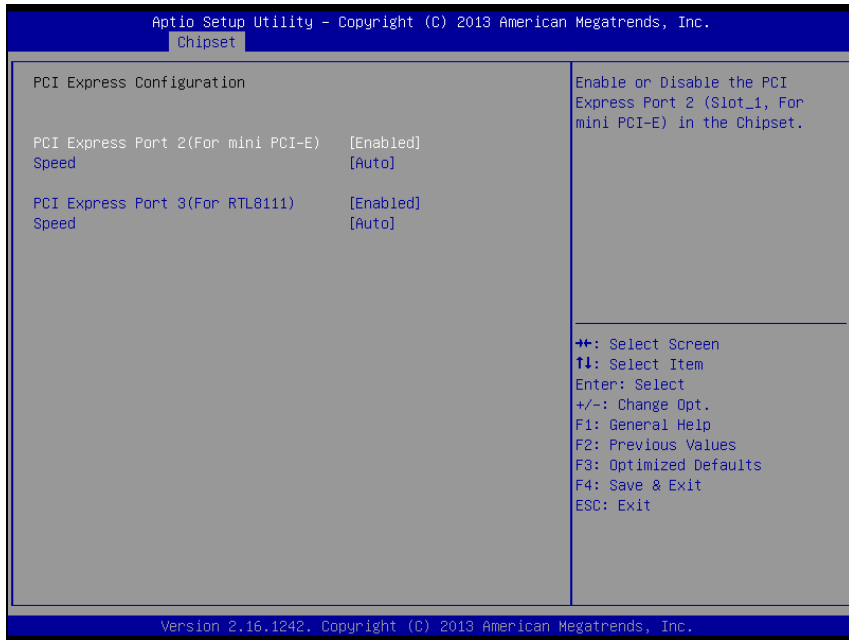

PCI Express Configuration screen

BIOS Setting	Options	Description/Purpose
PCI Express Port 2(For mini PCI-E)	- Disabled - Enabled	Enabled or Disabled PCI Express port 2
speed	- Auto - Gen1 - Gen2	Selection PCI Express port 2 Speed
PCI Express Port 3(For RTL8111)	- Disabled - Enabled	Enabled or Disabled PCI Express port 3
speed	- Auto - Gen1 - Gen2	Selection PCI Express port 3 Speed

## 3-4-6. Security

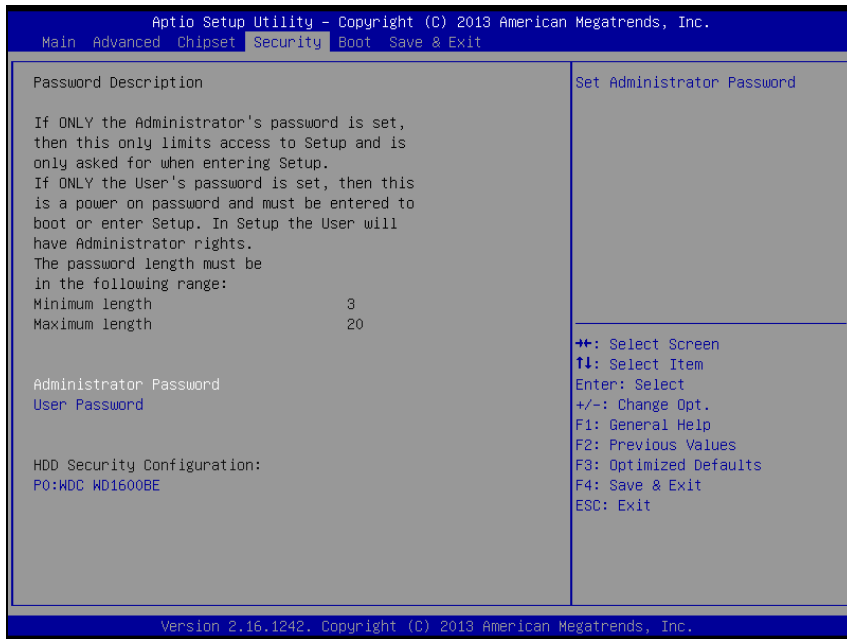

Security screen

BIOS Setting	Options	Description/Purpose
Administrator Password	Password can be 3-20 alphanumeric characters.	Specifies the administrator password.
User Password	Password can be 3-20 alphanumeric characters.	Specifies the user password.
HDD Security Configuration:	Sub-menu	Set HDD password.

## 3-4-7. Boot

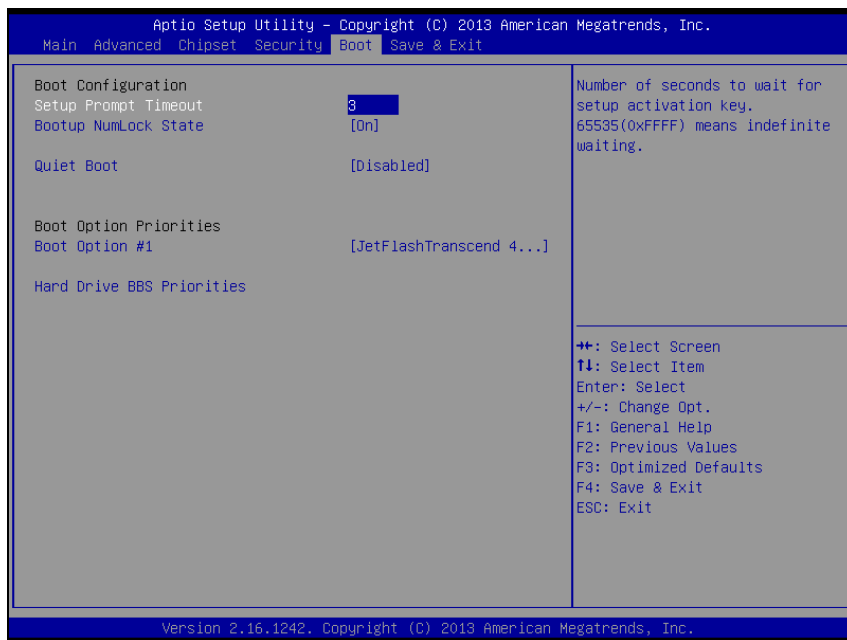

Boot screen

BIOS Setting	Options	Description/Purpose
Setup Prompt Timeout	Numeric	Number of seconds to wait for setup activation key.
Bootup NumLock State	- On - Off	Specifies the power-on state of the NumLock Key.
Quiet Boot	- Disabled - Enabled	Enable/Disable Quiet Boot Options
Boot Option #1~#n	- [Drive(s)] - Disabled	Allows setting boot option listed in Hard Drive BBS Priorities.
Hard Drive BBS Priorities	Sub-Menu	Allow user to select boot order of available drive(s)

## 3-4-7-1. Hard Drive BBS Priorities

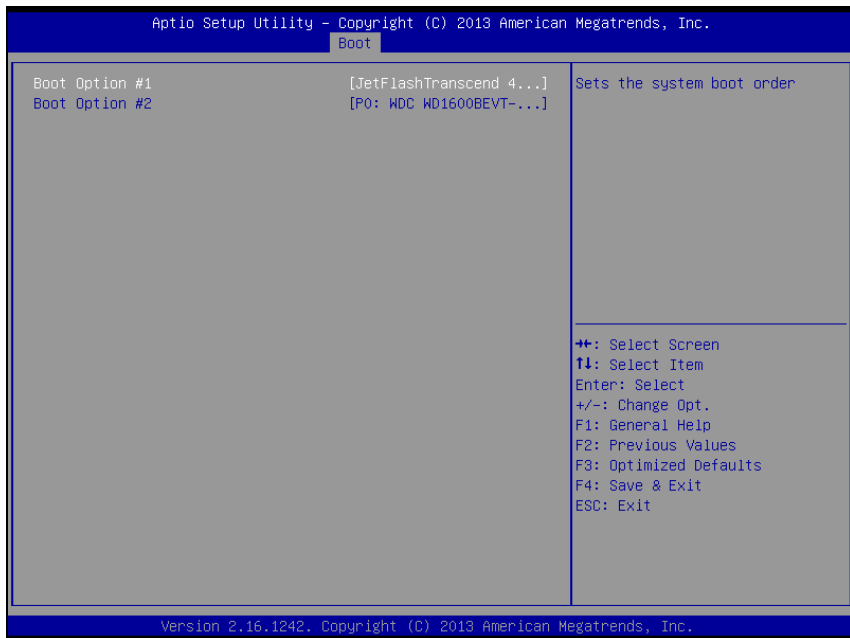

Hard drive BBS priorities screen

BIOS Setting	Options	Description/Purpose
Boot Option #1 - #n	- [Drive(s)] - Disabled	Change the boot order of available drive(s).

## 3-4-8. Save &amp; Exit

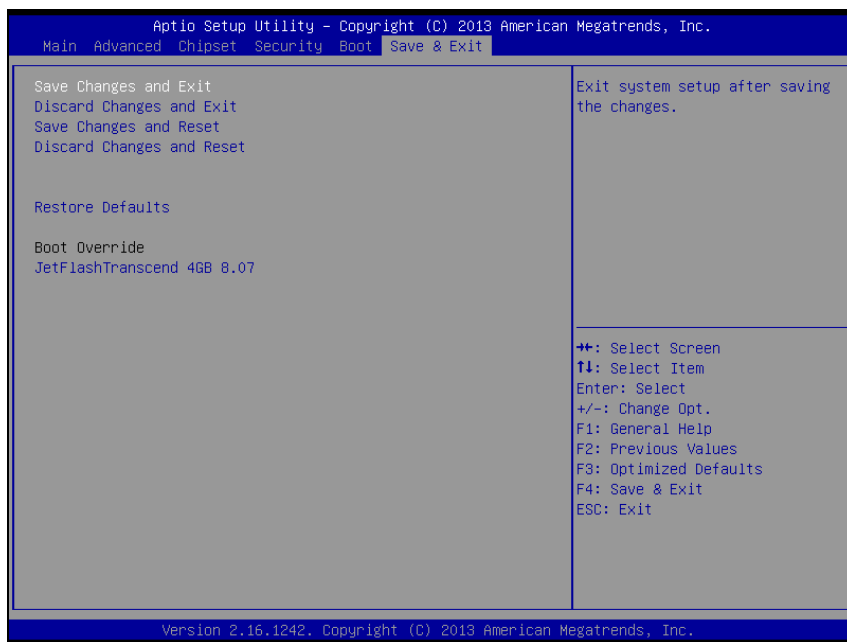

Save &amp; Exit screen

BIOS Setting	Options	Description/Purpose
Save Changes and Exit	No changeable options	Exits and saves the changes in NVRAM.
Discard Changes and Exit	No changeable options	Exits without saving any changes made in BIOS settings.
Save Changes and Reset	No changeable options	Saves the changes in NVRAM and resets.
Discard Changes and Reset	No changeable options	Resets without saving any changes made in BIOS settings.
Restore Defaults	No changeable options	Loads the optimized defaults for BIOS settings.
Boot Override	- [Drive(s)]	Forces to boot from selected [drive(s)].

## **3-5. WATCHDOG TIMER CONFIGURATION**

The I/O port address of the watchdog timer is 2E (hex) and 2F (hex). 2E (hex) is the address port. 2F (hex) is the data port. User must first assign the address of register by writing address value into address port 2E (hex), then write/read data to/from the assigned register through data port 2F (hex).

### **3-5-1. Configuration Sequence**

To program F81866 configuration registers, the following configuration sequence must be followed:

1. Enter the extended function mode

To place the chip into the Extended Function Mode, two successive writes of 0x87 must be applied to Extended Function Enable Registers (EFERs, i.e. 2Eh or 4Eh).

2. Configure the configuration registers

The chip selects the Logical Device and activates the desired Logical Devices through Extended Function Index Register (EFIR) and Extended Function Data Register (EFDR). The EFIR is located at the same address as the EFER, and the EFDR is located at address (EFIR+1). First, write the Logical Device Number (i.e. 0x07) to the EFIR and then write the number of the desired Logical Device to the EFDR. If accessing the Chip (Global) Control Registers, this step is not required. Secondly, write the address of the desired configuration register within the Logical Device to the EFIR and then write (or read) the desired configuration register through the EFDR.

3. Exit the extended function mode

To exit the Extended Function Mode, writing 0xAA to the EFER is required. Once the chip exits the Extended Function Mode, it is in the normal running mode and is ready to enter the configuration mode.

### 3-5-2. Code Example for Watchdog Timer

Enable watchdog timer and set the timeout interval as 30 seconds.

```
;----- Enter to extended function mode -----  
mov    dx,    2eh  
mov    al,    87h  
out    dx,    al  
out    dx,    al  
;----- Select Logical Device 7 of watchdog timer -----  
mov    al,    07h  
out    dx,    al  
inc    dx  
mov    al,    07h  
out    dx,    al  
;----- Enable Watch dog feature -----  
mov    al,    030h  
out    dx,    al  
inc    dx  
mov    al,    01h  
out    dx,    al  
;----- Enable Watch PME-----  
dec    dx  
mov    al,    0FAh  
out    dx,    al  
inc    dx  
in     al,    dx  
and    al,    51h  
out    dx,    al  
;----- Set second as counting unit -----  
dec    dx  
mov    al,    0f5h  
out    dx,    al  
inc    dx
```



```
in    al,    dx
and   al,    30h
out   dx,    al
```

*;----- Set timeout interval as 30seconds and start counting -----*

```
dec   dx
mov   al,    0f6h
out   dx,    al
inc   dx
mov   al,    1Eh
out   dx,    al
```

*;----- Exit the extended function mode -----*

```
dec   dx
mov   al,    0aah
out   dx,    al
```

## 3-6. BIOS UPDATE INSTRUCTIONS

### 3-6-1. Before System BIOS UPDATE

1. Prepare a bootable media (e.g. USB storage device) which can boot system to DOS prompt.
2. Download and save the BIOS file (e.g. [62250PD2.bin](#)) to the bootable device.
3. Copy AMI flash utility – AFUDOS.exe (V3.03) into the bootable device
4. Make sure the target system can first boot to the bootable device.
  - a. Connect the bootable USB device.
  - b. Turn on the computer and press <Del> or <Esc> key during boot to enter BIOS setup menu.
  - c. System will go into the BIOS setup menu.
  - d. Select [Boot] menu as the picture shows below.
  - e. Select [Hard Drive BBS Priorities], set the USB bootable device as the 1<sup>st</sup> boot device.
  - f. Press <F4> key to save configuration and exit the BIOS setup menu.



### 3-6-2. AFUDOS Command for System BIOS Update

AFUDOS.exe is aforementioned AMI firmware update utility; the command line is shown as below:

AFUDOS <ROM File Name> [option1] [option2]...

You can type `AFUDOS /?` to see all the definition of each control options. The recommended options for BIOS ROM update consist of following parameters:

`/P`: program main BIOS image

`/B`: program Boot Block

`/N`: program NVRAM

`/X`: don't check ROM ID

### 3-6-3. BIOS Update Procedure

1. Use the bootable USB device to boot up system into the MS-DOS command prompt
2. Type in `AFUDOS 6225xxxx.bin /p /b /n /x` and press enter to start the flash procedure

**Note:** `xxxx` means the BIOS revision part, ex. 0PD2...

3. During the update procedure, you will see the BIOS update process status and its percentage. **Beware!** Do not turn off or reset your computer before the update is complete, or it may crash the BIOS ROM and make the system unable to boot up next time. The whole update process may take up to 3 minutes.
4. After the BIOS update is complete, the messages from AFUDOS utility should be like the figure shown below.

```
C:\AFU\3.04>afudos.exe 62250PD2.BIN /p /b /n /x
+-----+
|                                     |
|             AMI Firmware Update Utility v3.04.00             |
|   Copyright (C)2012 American Megatrends Inc. All Rights Reserved.   |
+-----+
Reading flash ..... done
- ME Data Size checking . ok
- FFS checksums ..... ok
Erasing Boot Block ..... done
Updating Boot Block ..... done
Verifying Boot Block ..... done
Erasing Main Block ..... done
Updating Main Block ..... done
Verifying Main Block ..... done
Erasing NURAM Block ..... done
Updating NURAM Block ..... done
Verifying NURAM Block ..... done

C:\AFU\3.04>
C:\AFU\3.04>_
```

5. You can restart the system and boot up with new BIOS now
6. Update is complete after restart
7. Verify during the following boot that BIOS version displayed at the initialization screen has changed.



Version 2.16.1242. Copyright (C) 2013 American Megatrends, Inc.  
BIOS Date: 04/03/2014 10:05:49 Ver: 62250PD2  
Press <DEL> or <ESC> to enter setup.

B2

## 3-7. SYSTEM RESOURCE MAP

### 3-7-1. D6!\* , &&F5 ŽF6

#### Interrupt Map

IRQ	ASSIGNMENT
0	System timer
1	Standard PS/2 Keyboard
3	Communications Port (COM2)
4	Communications Port (COM1)
5	Printer Port (LPT1)
7	Communications Port (COM3)
7	Communications Port (COM4)
8	High precision event timer
16	Intel® Pentium® processor N- and J-series / Intel® Celeron® processor N- and J-series PCI Express - Root Port 1 - 0F48
17	Intel® Pentium® processor N- and J-series / Intel® Celeron® processor N- and J-series PCI Express - Root Port 2 - 0F4A
18	Intel® Pentium® processor N- and J-series / Intel® Celeron® processor N- and J-series PCI Express - Root Port 3 - 0F4C
19	Intel® Pentium® processor N- and J-series / Intel® Celeron® processor N- and J-series PCI Express - Root Port 4 - 0F4E
19	Intel® Pentium® processor N- and J-series / Intel® Celeron® processor N- and J-series AHCI - 0F23
81 ~ 511	Microsoft ACPI-Compliant System
4294967291	Intel® HD Graphics
4294967292	Intel® USB 3.0 eXtensible Host Controller - 0100 (Microsoft)
4294967293	Intel® Trusted Execution Engine Interface
4294967294	Realtek PCIe GBE Family Controller

## DMA Channels Map

TIMER CHANNEL	ASSIGNMENT
Channel 4	Direct memory access controller

## I/O Map

I/O MAP	ASSIGNMENT
0x00000000-0x0000006F	PCI Express Root Complex
0x00000020-0x00000021	Programmable interrupt controller
0x00000024-0x00000025	Programmable interrupt controller
0x00000028-0x00000029	Programmable interrupt controller
0x0000002C-0x0000002D	Programmable interrupt controller
0x0000002E-0x0000002F	Motherboard resources
0x00000030-0x00000031	Programmable interrupt controller
0x00000034-0x00000035	Programmable interrupt controller
0x00000038-0x00000039	Programmable interrupt controller
0x0000003C-0x0000003D	Programmable interrupt controller
0x00000040-0x00000043	System timer
0x0000004E-0x0000004F	Motherboard resources
0x00000050-0x00000053	System timer
0x00000060-0x00000060	Standard PS/2 Keyboard
0x00000061-0x00000061	Motherboard resources
0x00000063-0x00000063	Motherboard resources
0x00000064-0x00000064	Standard PS/2 Keyboard
0x00000065-0x00000065	Motherboard resources
0x00000067-0x00000067	Motherboard resources
0x00000070-0x00000070	Motherboard resources
0x00000070-0x00000070	System CMOS/real time clock
0x00000078-0x000000CF7	PCI Express Root Complex

I/O MAP	ASSIGNMENT
0x00000080-0x0000008F	Motherboard resources
0x00000092-0x00000092	Motherboard resources
0x000000A0-0x000000A1	Programmable interrupt controller
0x000000A4-0x000000A5	Programmable interrupt controller
0x000000A8-0x000000A9	Programmable interrupt controller
0x000000AC-0x000000AD	Programmable interrupt controller
0x000000B0-0x000000B1	Programmable interrupt controller
0x000000B2-0x000000B3	Motherboard resources
0x000000B4-0x000000B5	Programmable interrupt controller
0x000000B8-0x000000B9	Programmable interrupt controller
0x000000BC-0x000000BD	Programmable interrupt controller
0x000002E8-0x000002EF	Communications Port (COM4)
0x000002F8-0x000002FF	Communications Port (COM2)
0x00000378-0x0000037F	Printer Port (LPT1)
0x000003B0-0x000003BB	Intel® HD Graphics
0x000003C0-0x000003DF	Intel® HD Graphics
0x000003E8-0x000003EF	Communications Port (COM3)
0x000003F8-0x000003FF	Communications Port (COM1)
0x00000400-0x0000047F	Motherboard resources
0x000004D0-0x000004D1	Programmable interrupt controller
0x00000500-0x000005FE	Motherboard resources
0x00000600-0x0000061F	Motherboard resources
0x00000680-0x0000069F	Motherboard resources
0x00000A00-0x00000A0F	Motherboard resources
0x00000A10-0x00000A1F	Motherboard resources
0x00000A20-0x00000A2F	Motherboard resources
0x00000D00-0x0000FFFF	PCI Express Root Complex
0x0000164E-0x0000164F	Motherboard resources
0x0000E000-0x0000E0FF	Realtek PCIe GBE Family Controller



I/O MAP	ASSIGNMENT
0x0000E000-0x0000E0FF	Intel® Pentium® processor N- and J-series / Intel® Celeron® processor N- and J-series PCI Express - Root Port 4 - 0F4E
0x0000F000-0x0000F01F	Intel® Pentium® processor N- and J-series / Intel® Celeron® processor N- and J-series Platform Control Unit - SMBus Port - 0F12
0x0000F020-0x0000F03F	Intel® Pentium® processor N- and J-series / Intel® Celeron® processor N- and J-series AHCI - 0F23
0x0000F040-0x0000F043	Intel® Pentium® processor N- and J-series / Intel® Celeron® processor N- and J-series AHCI - 0F23
0x0000F050-0x0000F057	Intel® Pentium® processor N- and J-series / Intel® Celeron® processor N- and J-series AHCI - 0F23
0x0000F060-0x0000F063	Intel® Pentium® processor N- and J-series / Intel® Celeron® processor N- and J-series AHCI - 0F23
0x0000F070-0x0000F077	Intel® Pentium® processor N- and J-series / Intel® Celeron® processor N- and J-series AHCI - 0F23
0x0000F080-0x0000F087	Intel® HD Graphics

## Memory Map

MEMORY MAP	ASSIGNMENT
0xE0000000-0xFFFFFFFF	Motherboard resources
0xFED01000-0xFED01FFF	Motherboard resources
0xFED03000-0xFED03FFF	Motherboard resources
0xFED04000-0xFED04FFF	Motherboard resources
0xFED0C000-0xFED0FFFF	Motherboard resources
0xFED08000-0xFED08FFF	Motherboard resources
0xFED1C000-0xFED1CFFF	Motherboard resources
0xFEE00000-0xFEEFFFFFFF	Motherboard resources
0xFE000000-0xFEFFFFFFF	Motherboard resources
0xD0604000-0xD0604FFF	Realtek PCIe GBE Family Controller
0xD0600000-0xD0603FFF	Realtek PCIe GBE Family Controller
0xD0600000-0xD0603FFF	Intel® Pentium® processor N- and J-series / Intel® Celeron® processor N- and J-series PCI Express - Root Port 4 - 0F4E
0xFED00000-0xFED003FF	High precision event timer
0xC0000000-0xD0711FFE	PCI Express Root Complex
0xC0000000-0xD0711FFE	Intel® HD Graphics
0xD0000000-0xD03FFFFF	Intel® HD Graphics
0xD0700000-0xD070FFFF	Intel® USB 3.0 eXtensible Host Controller - 0100 (Microsoft)
0xD0710000-0xD071001F	Intel® Pentium® processor N- and J-series / Intel® Celeron® processor N- and J-series Platform Control Unit - SMBus Port - 0F12
0xD0500000-0xD05FFFFF	Intel® Trusted Execution Engine Interface
0xD0400000-0xD04FFFFF	Intel® Trusted Execution Engine Interface
0xD0711000-0xD07117FF	Intel® Pentium® processor N- and J-series / Intel® Celeron® processor N- and J-series AHCI - 0F23

<b>MEMORY MAP</b>	<b>ASSIGNMENT</b>
0xE00000D0-0xE00000DB	Intel® Sideband Fabric Device
0xFF000000-0xFFFFFFFF	Intel® 82802 Firmware Hub Device
0xA0000-0xBFFFF	PCI Express Root Complex
0xA0000-0xBFFFF	Intel® HD Graphics
0xC0000-0xDFFFF	PCI Express Root Complex
0xE0000-0xFFFFF	PCI Express Root Complex

**3-7-& D6!\*, &&F7**

.

**Interrupt Map**

<b>IRQ</b>	<b>ASSIGNMENT</b>
IRQ 1	Standard PS/2 Keyboard
IRQ 19	Standard AHCI 1.0 Serial ATA Controller
IRQ 19	PCI standard PCI-to-PCI bridge
IRQ 0	System timer
IRQ 8	High precision event timer
IRQ 4294967294	Intel(R) Celeron(R) Processor J1900
IRQ 4	Communications Port (COM1)
IRQ 3	Communications Port (COM2)
IRQ 7	Communications Port (COM3)
IRQ 10	Ethernet Controller
IRQ 10	Communications Port (COM4)
IRQ 23	Standard Enhanced PCI to USB Host Controller
IRQ 16	PCI standard PCI-to-PCI bridge
IRQ 22	High Definition Audio Controller
IRQ 17	PCI standard PCI-to-PCI bridge
IRQ 81	Microsoft ACPI-Compliant System
IRQ 82	Microsoft ACPI-Compliant System
IRQ 83	Microsoft ACPI-Compliant System
IRQ 84	Microsoft ACPI-Compliant System
IRQ 85	Microsoft ACPI-Compliant System
IRQ 86	Microsoft ACPI-Compliant System

<b>IRQ</b>	<b>ASSIGNMENT</b>
IRQ 87	Microsoft ACPI-Compliant System
IRQ 88	Microsoft ACPI-Compliant System
IRQ 89	Microsoft ACPI-Compliant System
IRQ 90	Microsoft ACPI-Compliant System
IRQ 91	Microsoft ACPI-Compliant System
IRQ 92	Microsoft ACPI-Compliant System
IRQ 93	Microsoft ACPI-Compliant System
IRQ 94	Microsoft ACPI-Compliant System
IRQ 95	Microsoft ACPI-Compliant System
IRQ 96	Microsoft ACPI-Compliant System
IRQ 97	Microsoft ACPI-Compliant System
IRQ 98	Microsoft ACPI-Compliant System
IRQ 99	Microsoft ACPI-Compliant System
IRQ 100	Microsoft ACPI-Compliant System
IRQ 101	Microsoft ACPI-Compliant System
IRQ 102	Microsoft ACPI-Compliant System
IRQ 103	Microsoft ACPI-Compliant System
IRQ 104	Microsoft ACPI-Compliant System
IRQ 105	Microsoft ACPI-Compliant System
IRQ 106	Microsoft ACPI-Compliant System
IRQ 107	Microsoft ACPI-Compliant System
IRQ 108	Microsoft ACPI-Compliant System
IRQ 109	Microsoft ACPI-Compliant System
IRQ 110	Microsoft ACPI-Compliant System
IRQ 111	Microsoft ACPI-Compliant System
IRQ 112	Microsoft ACPI-Compliant System
IRQ 113	Microsoft ACPI-Compliant System
IRQ 114	Microsoft ACPI-Compliant System

<b>IRQ</b>	<b>ASSIGNMENT</b>
IRQ 115	Microsoft ACPI-Compliant System
IRQ 116	Microsoft ACPI-Compliant System
IRQ 117	Microsoft ACPI-Compliant System
IRQ 118	Microsoft ACPI-Compliant System
IRQ 119	Microsoft ACPI-Compliant System
IRQ 120	Microsoft ACPI-Compliant System
IRQ 121	Microsoft ACPI-Compliant System
IRQ 122	Microsoft ACPI-Compliant System
IRQ 123	Microsoft ACPI-Compliant System
IRQ 124	Microsoft ACPI-Compliant System
IRQ 125	Microsoft ACPI-Compliant System
IRQ 126	Microsoft ACPI-Compliant System
IRQ 127	Microsoft ACPI-Compliant System
IRQ 128	Microsoft ACPI-Compliant System
IRQ 129	Microsoft ACPI-Compliant System
IRQ 130	Microsoft ACPI-Compliant System
IRQ 131	Microsoft ACPI-Compliant System
IRQ 132	Microsoft ACPI-Compliant System
IRQ 133	Microsoft ACPI-Compliant System
IRQ 134	Microsoft ACPI-Compliant System
IRQ 135	Microsoft ACPI-Compliant System
IRQ 136	Microsoft ACPI-Compliant System
IRQ 137	Microsoft ACPI-Compliant System
IRQ 138	Microsoft ACPI-Compliant System
IRQ 139	Microsoft ACPI-Compliant System
IRQ 140	Microsoft ACPI-Compliant System
IRQ 141	Microsoft ACPI-Compliant System
IRQ 142	Microsoft ACPI-Compliant System

<b>IRQ</b>	<b>ASSIGNMENT</b>
IRQ 143	Microsoft ACPI-Compliant System
IRQ 144	Microsoft ACPI-Compliant System
IRQ 145	Microsoft ACPI-Compliant System
IRQ 146	Microsoft ACPI-Compliant System
IRQ 147	Microsoft ACPI-Compliant System
IRQ 148	Microsoft ACPI-Compliant System
IRQ 149	Microsoft ACPI-Compliant System
IRQ 150	Microsoft ACPI-Compliant System
IRQ 151	Microsoft ACPI-Compliant System
IRQ 152	Microsoft ACPI-Compliant System
IRQ 153	Microsoft ACPI-Compliant System
IRQ 154	Microsoft ACPI-Compliant System
IRQ 155	Microsoft ACPI-Compliant System
IRQ 156	Microsoft ACPI-Compliant System
IRQ 157	Microsoft ACPI-Compliant System
IRQ 158	Microsoft ACPI-Compliant System
IRQ 159	Microsoft ACPI-Compliant System
IRQ 160	Microsoft ACPI-Compliant System
IRQ 161	Microsoft ACPI-Compliant System
IRQ 162	Microsoft ACPI-Compliant System
IRQ 163	Microsoft ACPI-Compliant System
IRQ 164	Microsoft ACPI-Compliant System
IRQ 165	Microsoft ACPI-Compliant System
IRQ 166	Microsoft ACPI-Compliant System
IRQ 167	Microsoft ACPI-Compliant System
IRQ 168	Microsoft ACPI-Compliant System
IRQ 169	Microsoft ACPI-Compliant System
IRQ 170	Microsoft ACPI-Compliant System

<b>IRQ</b>	<b>ASSIGNMENT</b>
IRQ 171	Microsoft ACPI-Compliant System
IRQ 172	Microsoft ACPI-Compliant System
IRQ 173	Microsoft ACPI-Compliant System
IRQ 174	Microsoft ACPI-Compliant System
IRQ 175	Microsoft ACPI-Compliant System
IRQ 176	Microsoft ACPI-Compliant System
IRQ 177	Microsoft ACPI-Compliant System
IRQ 178	Microsoft ACPI-Compliant System
IRQ 179	Microsoft ACPI-Compliant System
IRQ 180	Microsoft ACPI-Compliant System
IRQ 181	Microsoft ACPI-Compliant System
IRQ 182	Microsoft ACPI-Compliant System
IRQ 183	Microsoft ACPI-Compliant System
IRQ 184	Microsoft ACPI-Compliant System
IRQ 185	Microsoft ACPI-Compliant System
IRQ 186	Microsoft ACPI-Compliant System
IRQ 187	Microsoft ACPI-Compliant System
IRQ 188	Microsoft ACPI-Compliant System
IRQ 189	Microsoft ACPI-Compliant System
IRQ 190	Microsoft ACPI-Compliant System
IRQ 11	SM Bus Controller
IRQ 18	PCI standard PCI-to-PCI bridge

### **DMA Channels Map**

Channel 3 Printer Port (LPT1)
-------------------------------



**I/O Map**

<b>I/O MAP</b>	<b>ASSIGNMENT</b>
0x00000060-0x00000060	Standard PS/2 Keyboard
0x00000064-0x00000064	Standard PS/2 Keyboard
0x00000020-0x00000021	Programmable interrupt controller
0x00000024-0x00000025	Programmable interrupt controller
0x00000028-0x00000029	Programmable interrupt controller
0x0000002C-0x0000002D	Programmable interrupt controller
0x00000030-0x00000031	Programmable interrupt controller
0x00000034-0x00000035	Programmable interrupt controller
0x00000038-0x00000039	Programmable interrupt controller
0x0000003C-0x0000003D	Programmable interrupt controller
0x000000A0-0x000000A1	Programmable interrupt controller
0x000000A4-0x000000A5	Programmable interrupt controller
0x000000A8-0x000000A9	Programmable interrupt controller
0x000000AC-0x000000AD	Programmable interrupt controller
0x000000B0-0x000000B1	Programmable interrupt controller
0x000000B4-0x000000B5	Programmable interrupt controller
0x000000B8-0x000000B9	Programmable interrupt controller
0x000000BC-0x000000BD	Programmable interrupt controller
0x000004D0-0x000004D1	Programmable interrupt controller
0x0000F070-0x0000F077	Standard AHCI 1.0 Serial ATA Controller
0x0000F060-0x0000F063	Standard AHCI 1.0 Serial ATA Controller
0x0000F050-0x0000F057	Standard AHCI 1.0 Serial ATA Controller
0x0000F040-0x0000F043	Standard AHCI 1.0 Serial ATA Controller
0x0000F020-0x0000F03F	Standard AHCI 1.0 Serial ATA Controller
0x00000040-0x00000043	System timer
0x00000050-0x00000053	System timer
0x0000F080-0x0000F087	Intel(R) Celeron(R) Processor J1900
0x000003B0-0x000003BB	Intel(R) Celeron(R) Processor J1900
0x000003C0-0x000003DF	Intel(R) Celeron(R) Processor J1900

<b>I/O MAP</b>	<b>ASSIGNMENT</b>
0x00000378-0x0000037F	Printer Port (LPT1)
0x000003F8-0x000003FF	Communications Port (COM1)
0x000002F8-0x000002FF	Communications Port (COM2)
0x000003E8-0x000003EF	Communications Port (COM3)
0x0000E000-0x0000E0FF	Ethernet Controller
0x0000E000-0x0000E0FF	PCI standard PCI-to-PCI bridge
0x000002E8-0x000002EF	Communications Port (COM4)
0x00000000-0x0000006F	PCI bus
0x00000078-0x00000CF7	PCI bus
0x00000D00-0x0000FFFF	PCI bus
0x00000070-0x00000077	System CMOS/real time clock
0x00000070-0x00000077	Motherboard resources
0x00000A00-0x00000A0F	Motherboard resources
0x00000A10-0x00000A1F	Motherboard resources
0x00000A20-0x00000A2F	Motherboard resources
0x0000002E-0x0000002F	Motherboard resources
0x0000004E-0x0000004F	Motherboard resources
0x00000061-0x00000061	Motherboard resources
0x00000063-0x00000063	Motherboard resources
0x00000065-0x00000065	Motherboard resources
0x00000067-0x00000067	Motherboard resources
0x00000080-0x0000008F	Motherboard resources
0x00000092-0x00000092	Motherboard resources
0x000000B2-0x000000B3	Motherboard resources
0x00000680-0x0000069F	Motherboard resources
0x00000400-0x0000047F	Motherboard resources
0x00000500-0x000005FE	Motherboard resources
0x00000600-0x0000061F	Motherboard resources
0x0000F000-0x0000F01F	SM Bus Controller

I/O MAP	ASSIGNMENT
0x0000E000-0x0000E0FF	Intel® Pentium® processor N- and J-series / Intel® Celeron® processor N- and J-series PCI Express - Root Port 4 - 0F4E
0x0000F000-0x0000F01F	Intel® Pentium® processor N- and J-series / Intel® Celeron® processor N- and J-series Platform Control Unit - SMBus Port - 0F12
0x0000F020-0x0000F03F	Intel® Pentium® processor N- and J-series / Intel® Celeron® processor N- and J-series AHCI - 0F23
0x0000F040-0x0000F043	Intel® Pentium® processor N- and J-series / Intel® Celeron® processor N- and J-series AHCI - 0F23
0x0000F050-0x0000F057	Intel® Pentium® processor N- and J-series / Intel® Celeron® processor N- and J-series AHCI - 0F23
0x0000F060-0x0000F063	Intel® Pentium® processor N- and J-series / Intel® Celeron® processor N- and J-series AHCI - 0F23
0x0000F070-0x0000F077	Intel® Pentium® processor N- and J-series / Intel® Celeron® processor N- and J-series AHCI - 0F23
0x0000F080-0x0000F087	Intel® HD Graphics

## Memory Map

MEMORY MAP	ASSIGNMENT
0xFF000000-0xFFFFFFFF	Intel(R) 82802 Firmware Hub Device
0xD0706000-0xD07067FF	Standard AHCI 1.0 Serial ATA Controller
0xFED00000-0xFED003FF	High precision event timer
0xD0000000-0xD03FFFFFF	Intel(R) Celeron(R) Processor J1900
0xC0000000-0xCFFFFFFF	Intel(R) Celeron(R) Processor J1900
0xC0000000-0xCFFFFFFF	PCI bus
0xA0000-0xBFFFF	Intel(R) Celeron(R) Processor J1900
0xA0000-0xBFFFF	PCI bus
0xD0604000-0xD0604FFF	Ethernet Controller
0xD0600000-0xD0603FFF	Ethernet Controller
0xD0600000-0xD0603FFF	PCI standard PCI-to-PCI bridge
0xD0705000-0xD07053FF	Standard Enhanced PCI to USB Host Controller
0xC0000-0xDFFFF	PCI bus
0xE0000-0xFFFF	PCI bus
0xE0000000-0xEFFFFFFF	Motherboard resources
0xFED01000-0xFED01FFF	Motherboard resources
0xFED03000-0xFED03FFF	Motherboard resources
0xFED04000-0xFED04FFF	Motherboard resources
0xFED0C000-0xFED0FFFF	Motherboard resources
0xFED08000-0xFED08FFF	Motherboard resources
0xFED1C000-0xFED1CFFF	Motherboard resources
0xFEE00000-0xFEEFFFFFFF	Motherboard resources
0xFE000000-0xFEFFFFFFF	Motherboard resources
0xD0700000-0xD0703FFF	High Definition Audio Controller
0xD0704000-0xD070401F	SM Bus Controller
0xD0500000-0xD05FFFFFF	PCI Encryption/Decryption Controller
0xD0400000-0xD04FFFFFF	PCI Encryption/Decryption Controller

# ***SYSTEM DIAGRAMS***

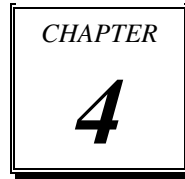

This appendix contains exploded diagrams and part numbers of the PA-6810 system.

Sections included:

- Exploded Diagram for Storage
- Exploded Diagram for System Top Module
- Exploded Diagram for MSR
- Exploded Diagram for i-Button
- Exploded Diagram for Fingerprint
- Exploded Diagram for RFID
- Exploded Diagram for System Bottom Case
- Exploded Diagram for VFD
- Exploded Diagram for Printer

## EXPLODED DIAGRAM FOR STORAGE

### Assembly

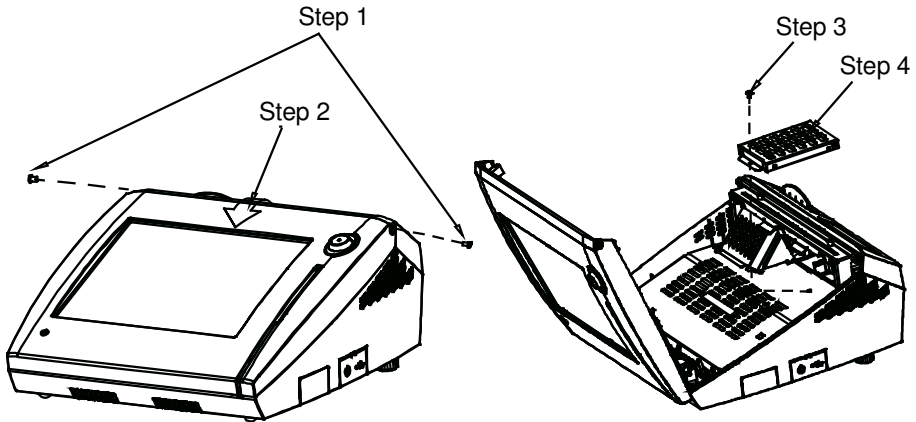

## EXPLODED DIAGRAM FOR HDD

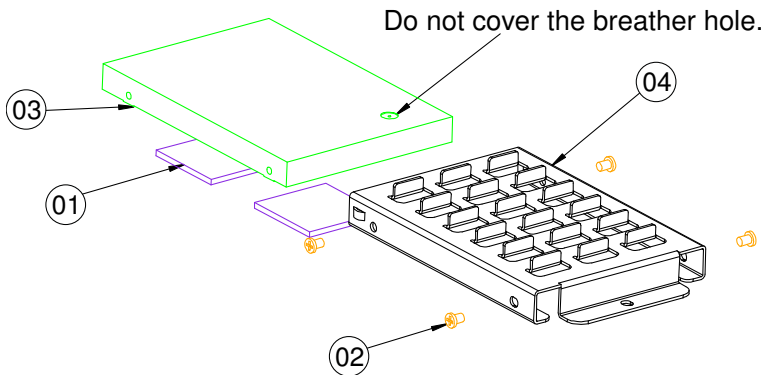

NO.	COMPONENT NAME	PART NO.	Q'TY
1	THERMAL PAD	81-006-83030004	2
2	SCREW	22-272-30004318	4
3	2.5" HDD OR SSD	--	1
4	HDD HOLDER	20-029-01001165	1

**EXPLODED DIAGRAM FOR SSD**

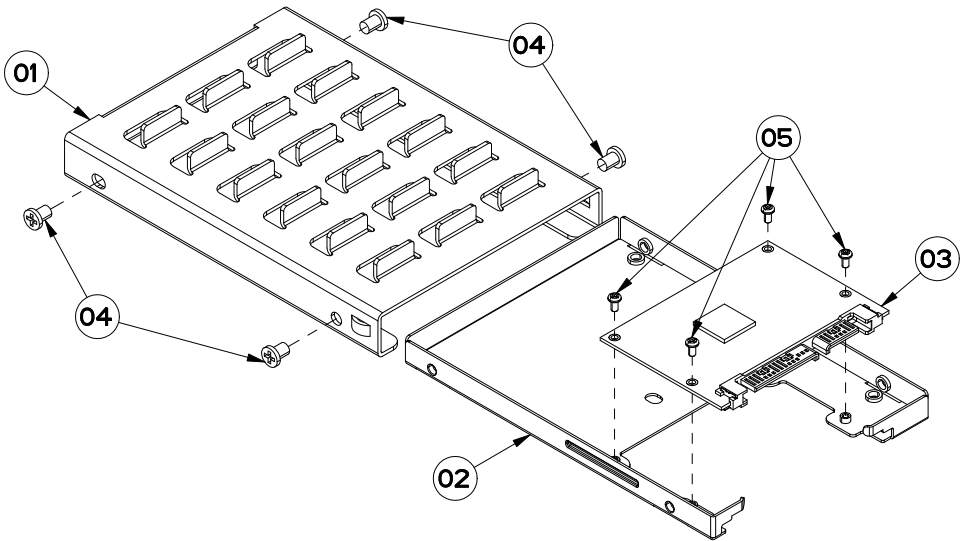

NO.	COMPONENT NAME	PART NO.	Q'TY
1	HDD HOLDER	20-029-01001165	1
2	SSD BRACKET	80-006-03001199	1
3	SSD	***-***-*****	1
4	SCREW	22-272-30004318	4
5	SCREW	22-222-16003015	4

## EXPLODED DIAGRAM FOR SYSTEM TOP MODULE

### Basic Construction

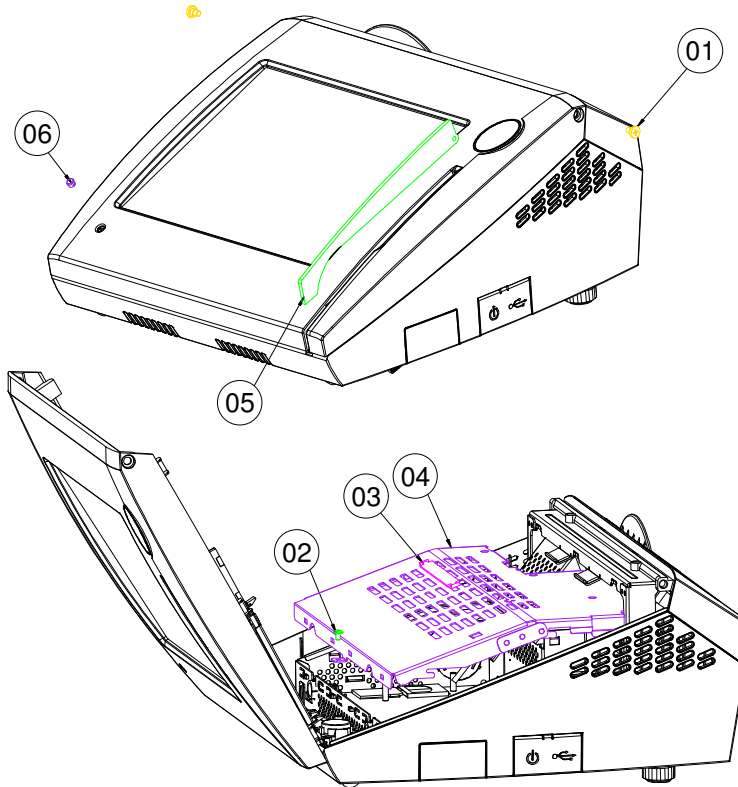

NO.	COMPONENT NAME	PART NO.	Q'TY
1	SCREW	22-272-40004311	2
2	SCREW	22-242-30005311	1
3	PULLER	30-080-04100000	1
4	INSIDE BOX TOP COVER	20-004-03001199	1
5	MSR EVA (FOR W/O MSR)	90-013-15100199	1
6	LED LENS	30-012-02100000	1



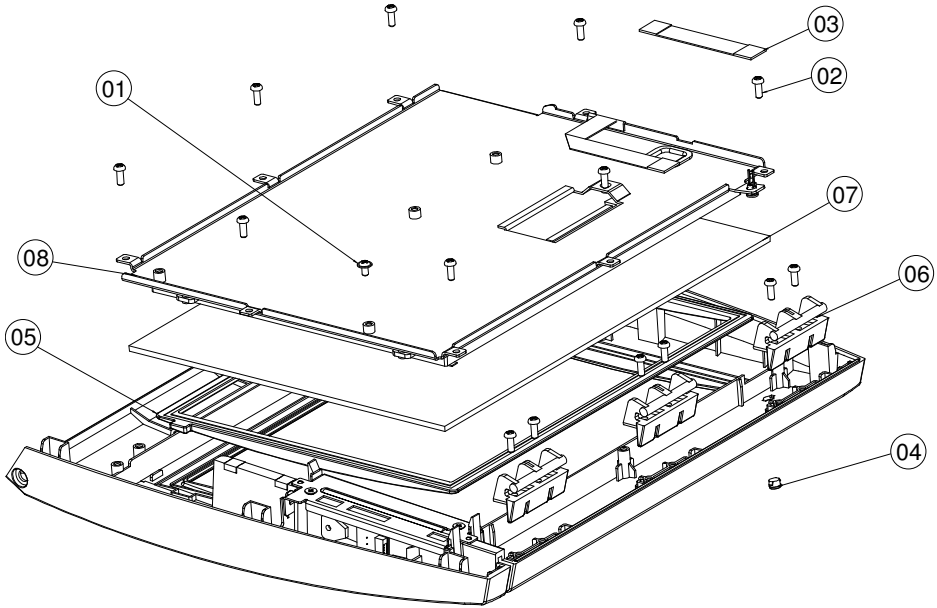

NO.	COMPONENT NAME	PART NO.	Q'TY
1	SCREW	22-242-30005311	1
2	SCREW	22-122-30080011	14
3	TOUCH CABLE	27-043-12402071	1
4	LED LENS	30-012-02100000	1
5	LCD RUBBER	30-013-01100199	1
6	HINGE	30-002-09130220	3
7	TOUCH PANEL	52-380-01510401	1
8	LCD ASSY (as Panel Module exploded drawing)	--	--

1024 x 768 LCD Panel

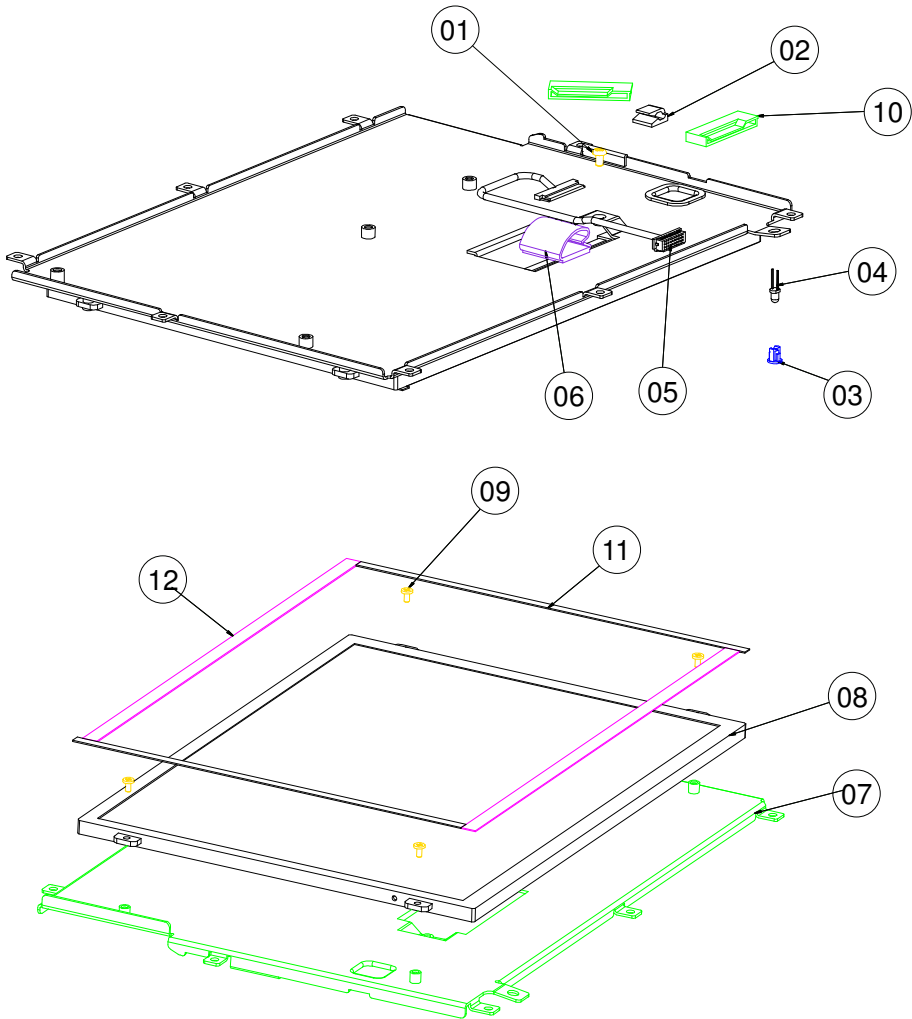

NO.	COMPONENT NAME	PART NO.	Q'TY
1	SCREW	22-230-30005811	1
2	CABLE CLAMP	30-059-04100000	1
3	LED HOUSING	30-014-04100165	1
4	LED CABLE	27-018-19704071	1
5	LVDS CABLE	27-020-16505111	1
6	CABLE CLAMP	30-023-04300010	1
7	CPT LCD HOLDER	20-029-03003199	1
8	CPT 10.4" LCD	52-351-01104019	1
9	SCREW	22-272-20004011	4
10	WIRE MOUNT	90-042-04200000	2
11	PORON_B	30-013-24700000	2
12	PORON_A	30-013-24600000	2

800 x 600 LCD Panel

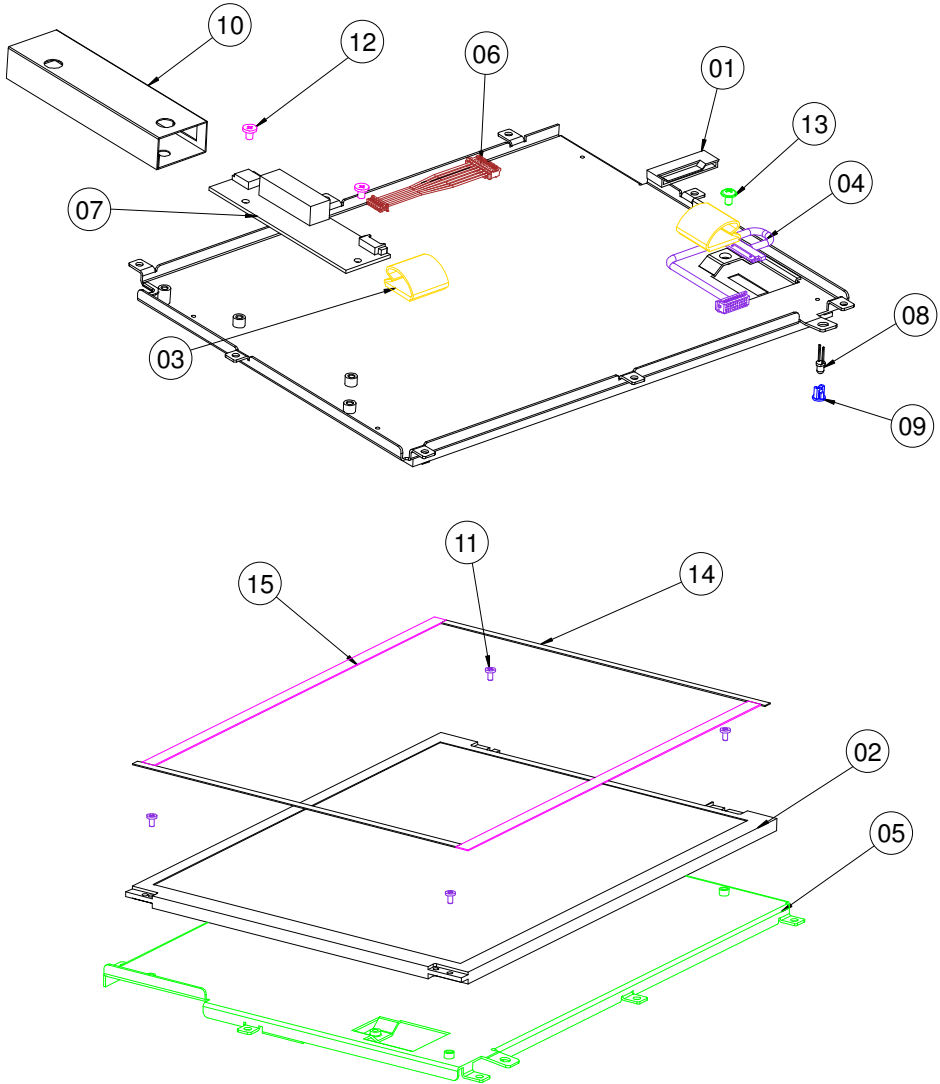

Regarding the part number of the top case hereinafter referred to in some tables, there are multiple options depending on colors and the functions it is made with.

Color	No peripheral accessory on top case	Support RFID	Support i-Button	Support fingerprint
Black	30-003-28610199		30-003-28210199	30-003-28810199
White	30-003-28410199		30-003-28010199	30-003-28810199
Red	30-003-28510199		30-003-28110199	30-003-28910199
Blue	30-003-28710199		30-003-28310199	30-003-28112199

### Front Cover

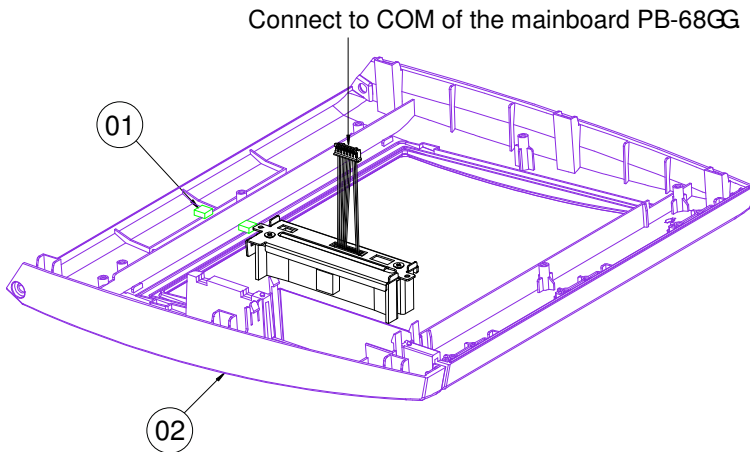

NO.	COMPONENT NAME	PART NO.	Q'TY
1	EVA BLOCK	30-013-15100165	2
2	TOP CASE	DEPENDS	1

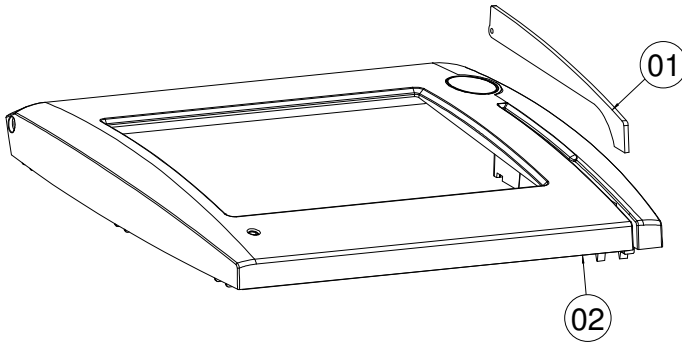

NO.	COMPONENT NAME	PART NO.	Q'TY
1	MSR EVA	90-013-15100199	1
2	TOP CASE	DEPENDS	1

**EXPLODED DIAGRAM FOR MSR**

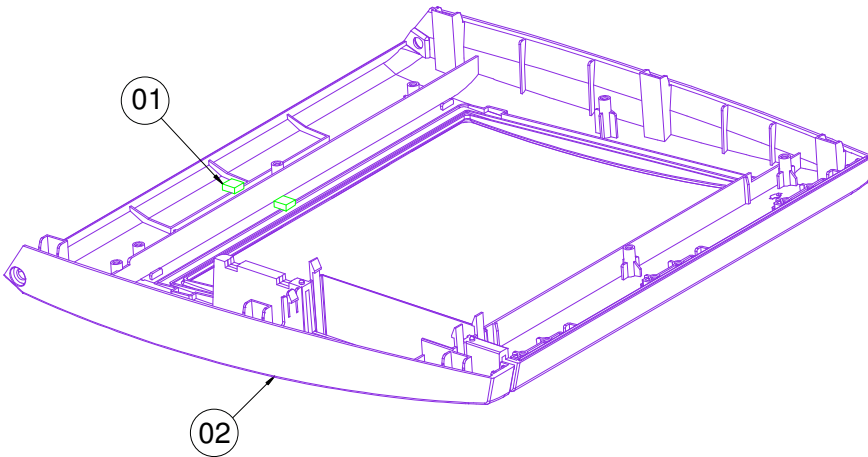

NO.	COMPONENT NAME	PART NO.	Q'TY
1	EVA BLOCK	30-013-15100165	2
2	TOP CASE	DEPENDS	1

**MSR Module**

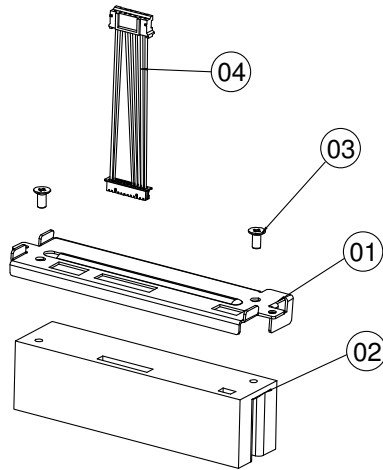

NO.	COMPONENT NAME	PART NO.	Q'TY
1	MSR BRACKET	20-029-03004165	1
	MSR BRAKET (MSR-JAPAN)	20-029-03005165	
2	MSR-SYKING /PS2	52-551-00883000	1
	MSR-IDTECH /PS2	52-151-08333416	
	BUTTON BOARD only /PS2	52-551-00300002	
	MSR-PROTECH /PS2	MB-3012RA-11N	
3	SCREW	22-222-30004011	2
4	MSR CABLE for SYSKING	27-014-16504111	1
	MSR CABLE (for ID TECH)	27-014-16504031	
5	MSR cable for PROTECH	27-014-29606111	1

## EXPLODED DIAGRAM FOR I-BUTTON

### Basic Construction

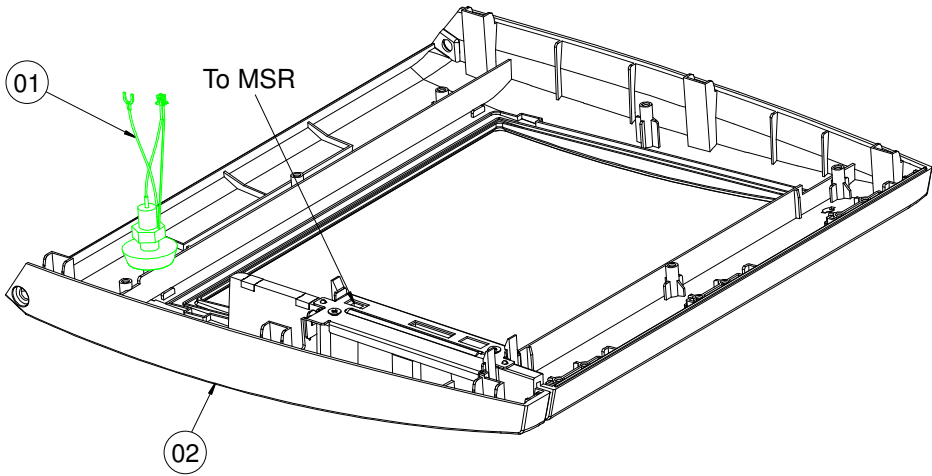

NO.	COMPONENT NAME	PART NO.	Q'TY
1	I-BUTTON ASSY	--	1
2	TOP CASE	DEPENDS	1



**i-Button Module**

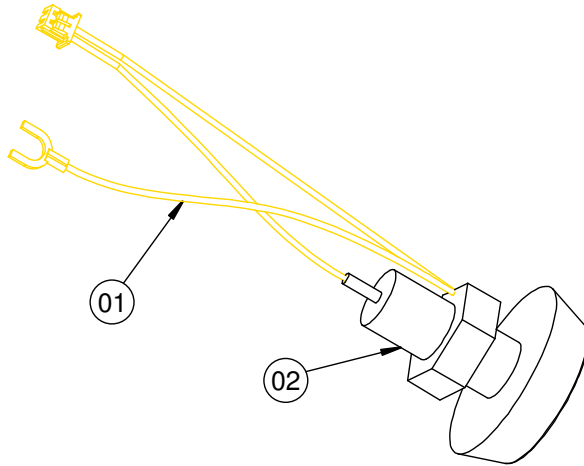

NO.	COMPONENT NAME	PART NO.	Q'TY
1	I BUTTON CABLE	27-022-16503071	1
2	I BUTTON	52-551-00100002	1

## EXPLODED DIAGRAM FOR FINGERPRINT

### Basic Construction

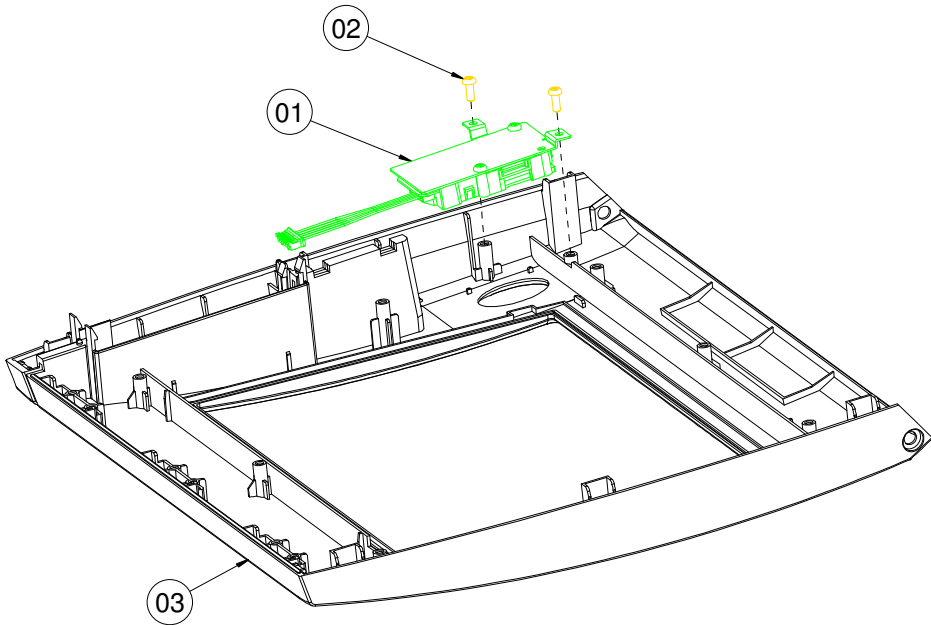

NO.	COMPONENT NAME	PART NO.	Q'TY
1	FINGERPRINTER ASSY	--	1
2	SCREW	22-122-30080011	2
3	TOP CASE	DEPENDS	1

**Fingerprint Module**

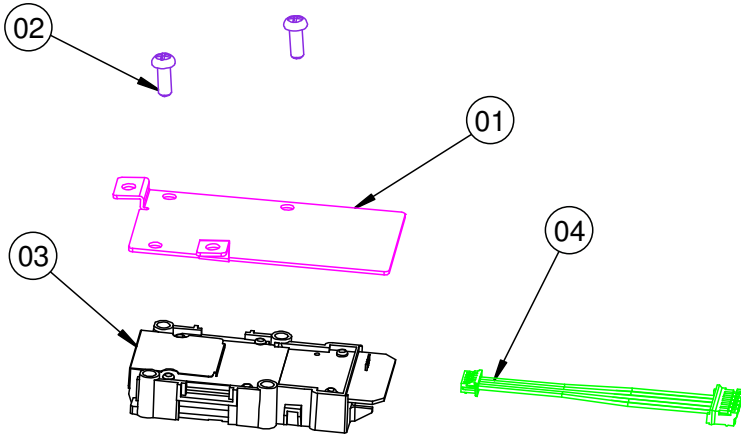

NO.	COMPONENT NAME	PART NO.	Q'TY
1	FINGERPRINTER BRACKET	20-029-03001199	1
2	SCREW	22-122-30080011	2
3	FINGERPRINTER MODULE	52-551-00501205	1
4	FINGERPRINTER CABLE	27-006-16506111	1

## EXPLODED DIAGRAM FOR RFID

### Basic Construction

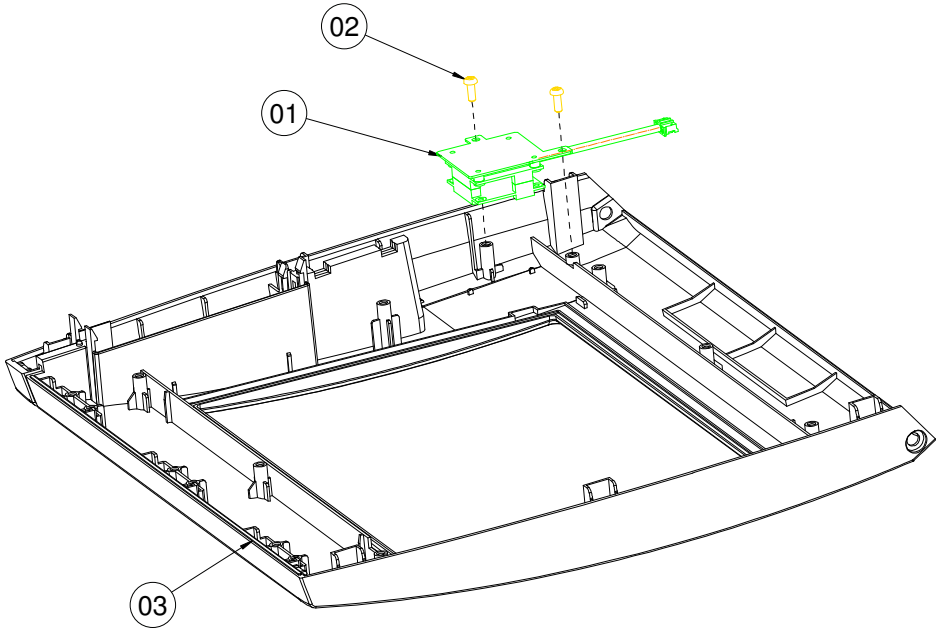

NO.	COMPONENT NAME	PART NO.	Q'TY
1	RFID ASSY	--	1
2	SCREW	22-122-30080011	2
3	TOP CASE	DEPENDS	1

**RFID Module**

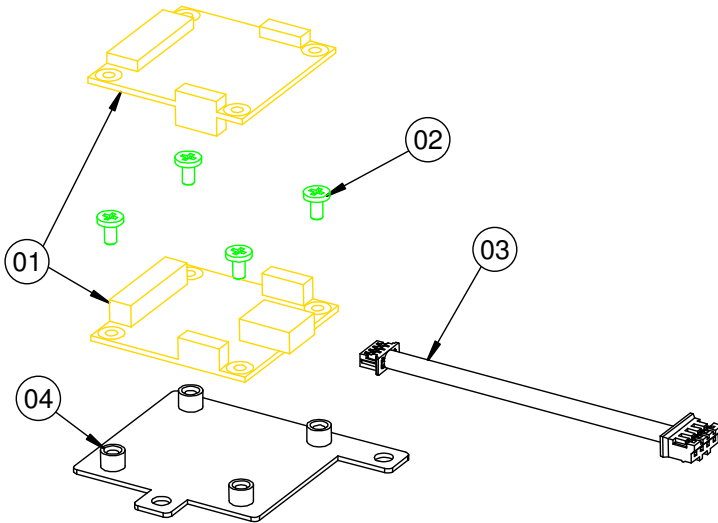

NO.	COMPONENT NAME	PART NO.	Q'TY
1	RFID MOUDLE	--	1
2	SCREW	22-272-20004011	4
3	RFID CABLE	27-068-19907111	1
4	RFID BRACKET	20-006-03001199	1

**EXPLODED DIAGRAM FOR SYSTEM BOTTOM CASE**

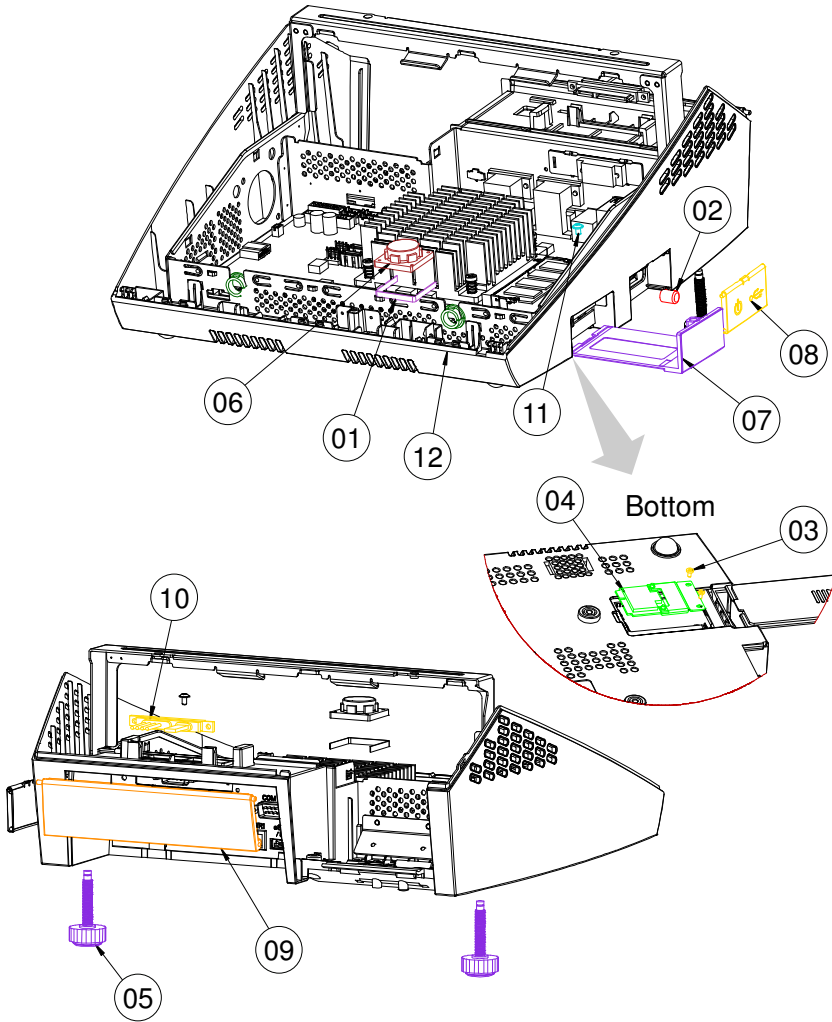

NO.	COMPONENT NAME	PART NO.	Q'TY
1	PORON	90-013-15200181	1
2	SWITCH CAP	30-001-28100099	1
3	SCREW	22-272-20004011	2
4	WIRELESS CARD ASSY	**-*-*****	1
5	FOOT	22-289-60035007	2
6	SPEAKER	13-500-08280018	1
7	MINI PCI DOOR	30-007-28110199	1
8	POWER COVER	30-002-28210199	1
9	IO COVER	30-002-28110199	1
10	SATA HDD CABLE	27-012-16504081	1
11	SCREW	22-242-30005311	1
12	INSIDE BOX ASSY 1	**-*-*****	1

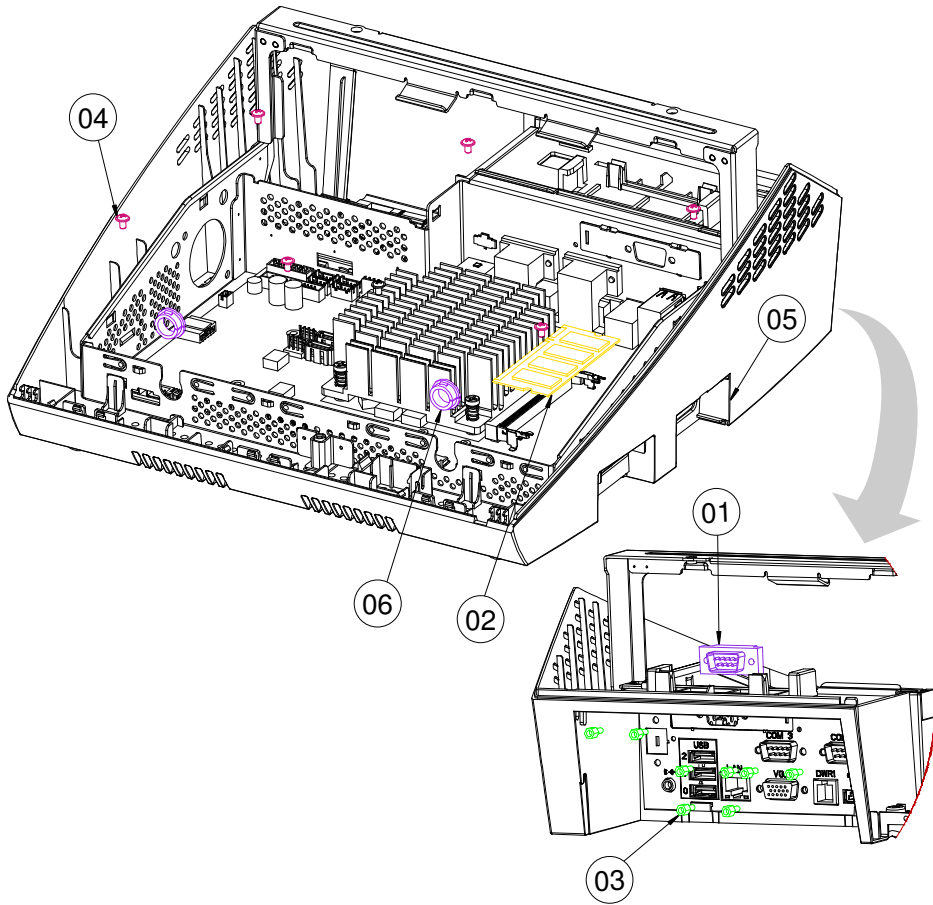

NO.	COMPONENT NAME	PART NO.	Q'TY
1	COM CABLE	27-024-16502031	1
2	RAM	**-*-**-*-*-*-*-*	1
3	No.4 Boss	22-692-40048051	8
4	SCREW	22-242-30005311	7
5	INSIDE BOX ASSY 2	**-*-**-*-*-*-*-*	1
6	OPEN CLOSED BUSHING	30-026-04300000	2



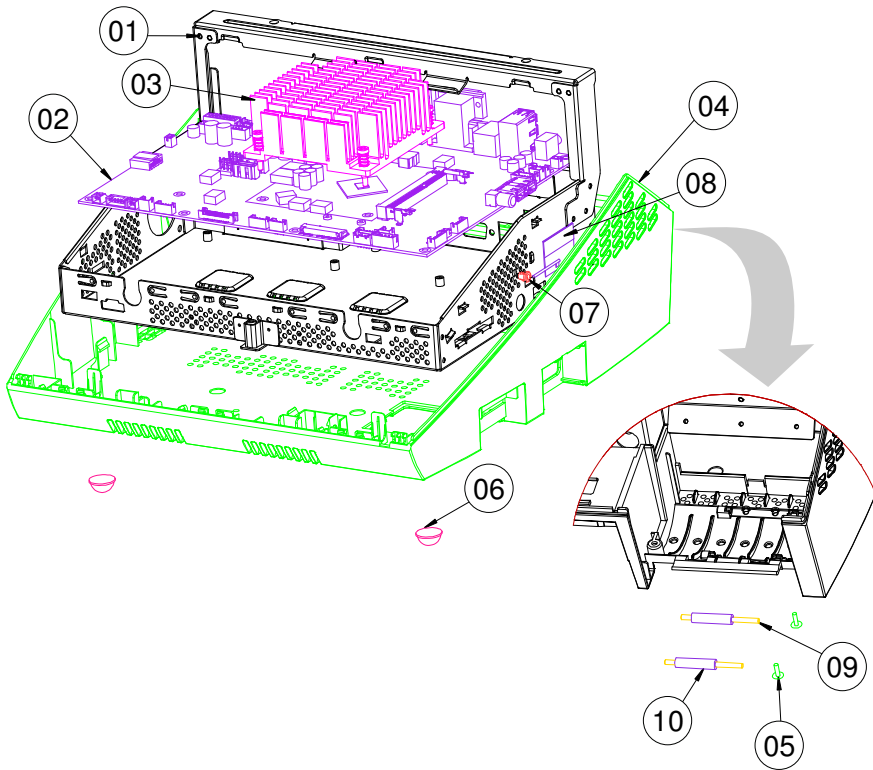

NO.	COMPONENT NAME	PART NO.	Q'TY
1	INSIDE BOX ASSY	20-040-03001296	1
2	PCBA	PB-6822	1
3	HEAT SINK MODULE	--	1
4	BOTTOM CASE	30-001-28110220	1
5	CANOE CLIP	30-076-04200000	2
6	RUBBER FOOT	30-004-01500000	2
7	SNAP BUSHING	30-026-04100008	1
8	WIRELESS ANTENA	27-029-00003072	1
9	ROLLER PIN	20-045-19012199	2
10	ROLLER	30-041-04100165	2

Cash Drawer2 Port

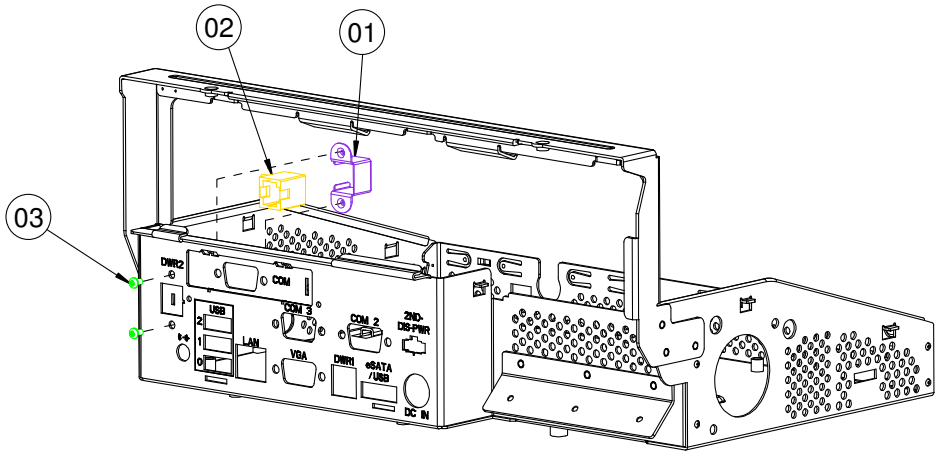

NO.	COMPONENT NAME	PART NO.	Q'TY
1	RJ-11 HOLDER	80-029-03002165	1
2	CASH DRAWER CABLE	27-026-16505111	1
3	SCREW	22-232-25004011	2

COM Port

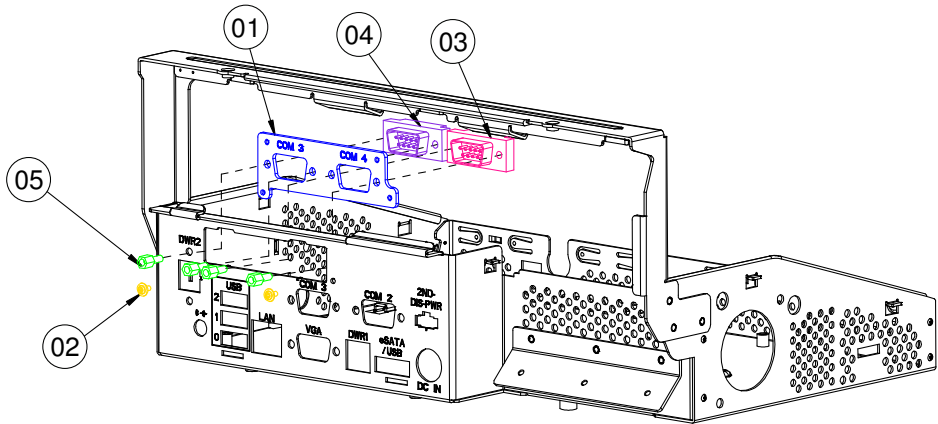

NO.	COMPONENT NAME	PART NO.	Q'TY
1	COM PORT PLATE	20-005-03001220	1
2	SCREW	22-272-20004011	2
3	COM CABLE-B	27-024-16502031	1
4	COM CABLE-A	27-024-20804031	1
5	No.4 Boss	22-692-40048051	4

Parallel Port (Optional)

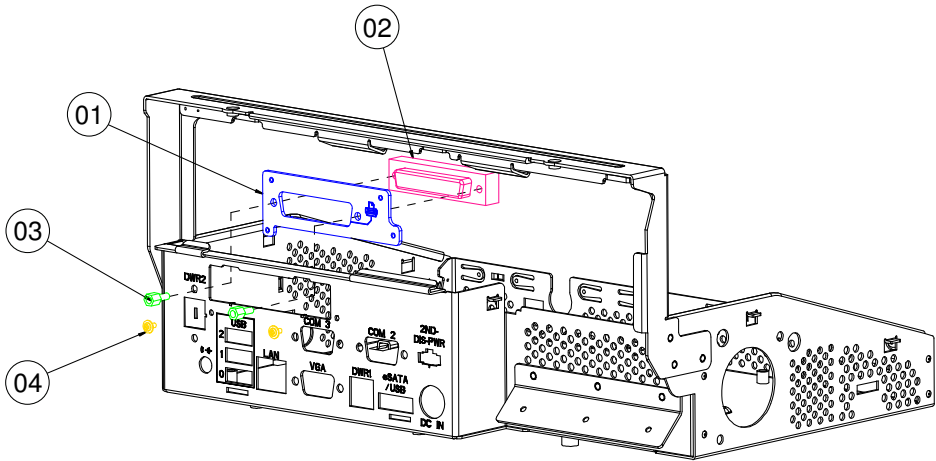

NO.	COMPONENT NAME	PART NO.	Q'TY
1	LPT PORT PLATE	20-005-03002220	1
2	LPT CABLE	27-004-22005111	1
3	No.4 Boss	22-692-40048051	2
4	SCREW	22-232-20004311	2

## EXPLODED DIAGRAM FOR VFD

### VFD Module

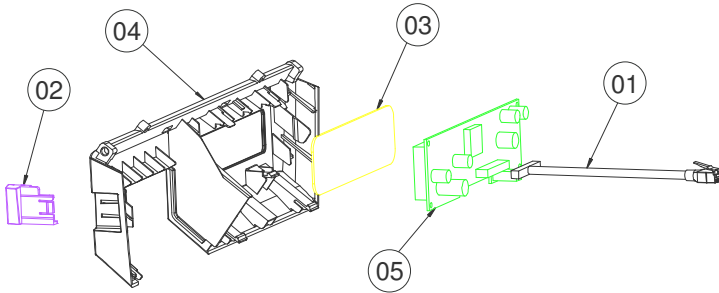

NO.	COMPONENT NAME	PART NO.	Q'TY
1	VFD CABLE		1
2	PRINTER EJECTOR WITH PRINTER	30-002-28410199	1
3	VFD LENS	30-021-02130199	1
4	VFD COVER	30-002-28910199	1
5	VFD MOUDULE	52-901-17001703	1
		MB-4013RA-11N	

### Without VFD Module

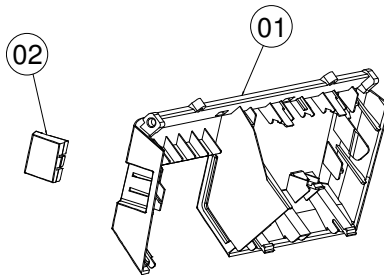

NO.	COMPONENT NAME	PART NO.	Q'TY
1	VFD COVER	30-002-28910199	1
2	PRINTER EJECTOR WO PRINTER	30-002-28510199	1

## EXPLODED DIAGRAM FOR PRINTER

### Printer Control Board

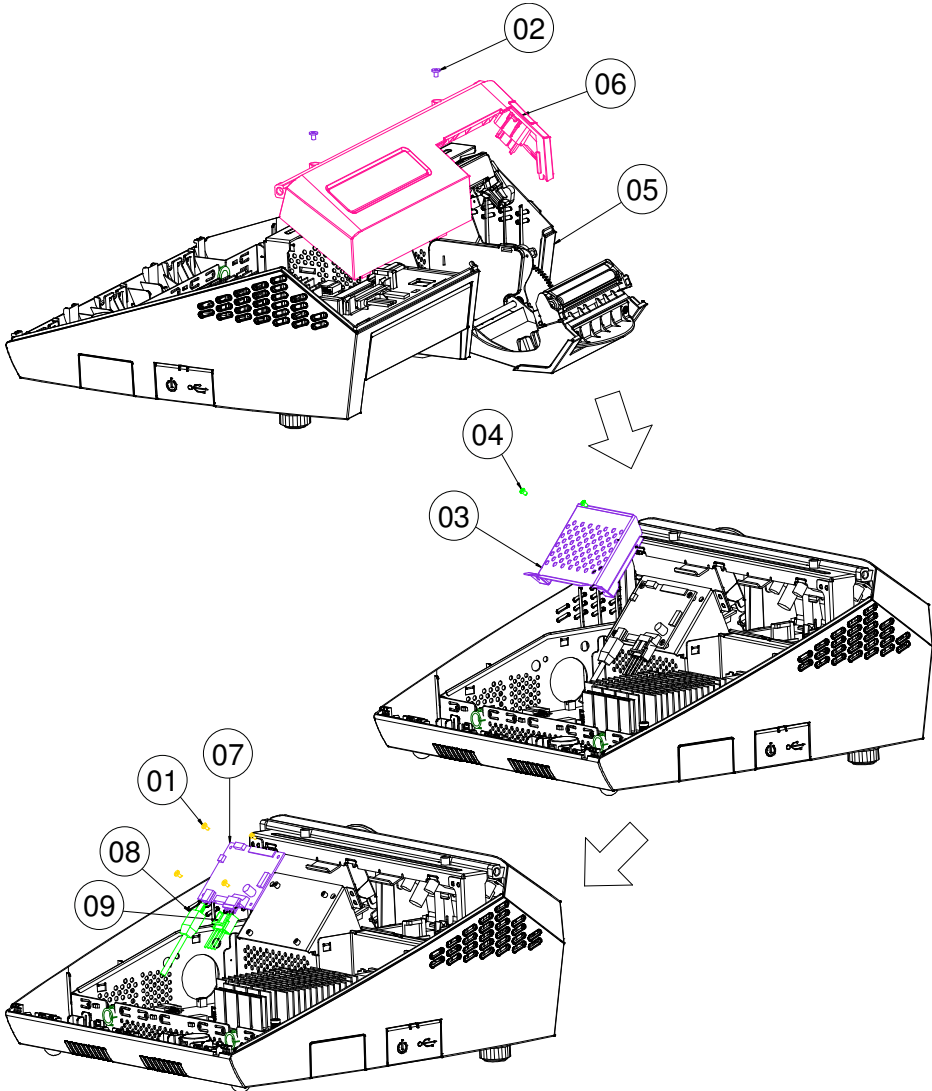

3 Inch Printer

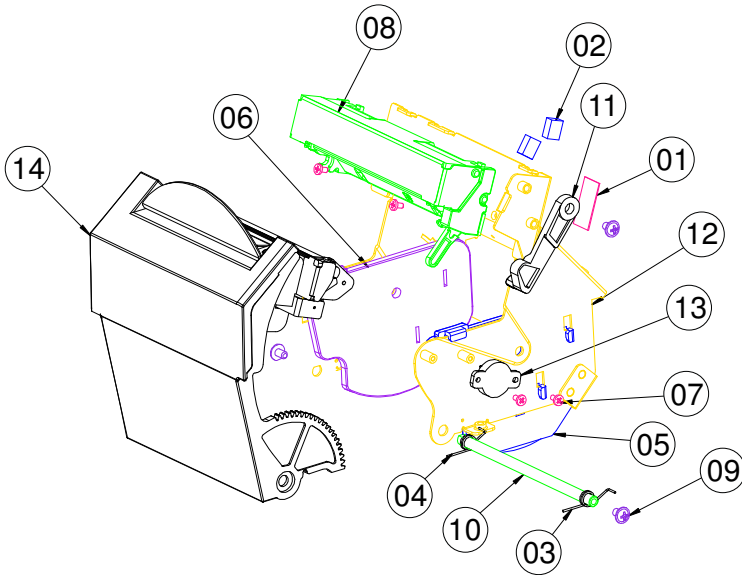

NO.	COMPONENT NAME	PART NO.	Q'TY
1	PC SHEET	90-056-02100199	1
2	EMI SHIELDING GASKET	90-050-31100000	2
3	PRINTER COVER SPRING R	23-000-00000502	1
4	PRINTER COVER SPRING L	23-000-01000502	1
5	3IN SIDE WALL R	30-002-28610199	1
6	3IN SIDE WALL L	30-002-28710199	1
7	SCREW	22-272-20004011	4
8	3IN PRINTER MOUDULE A	52-701-00017003	1
9	SCREW	22-242-30005311	3
10	PAPER COVER PIN	20-045-19011199	1
11	PRINTER ADD ARM	30-002-09110199	1
12	PRINTER BOX3 ASSY	20-040-03002199	1
13	ROTARY DAMPER	30-002-09110000	1
14	3IN PRINTER COVER ASSY	***-***-*****	1

Printer Box

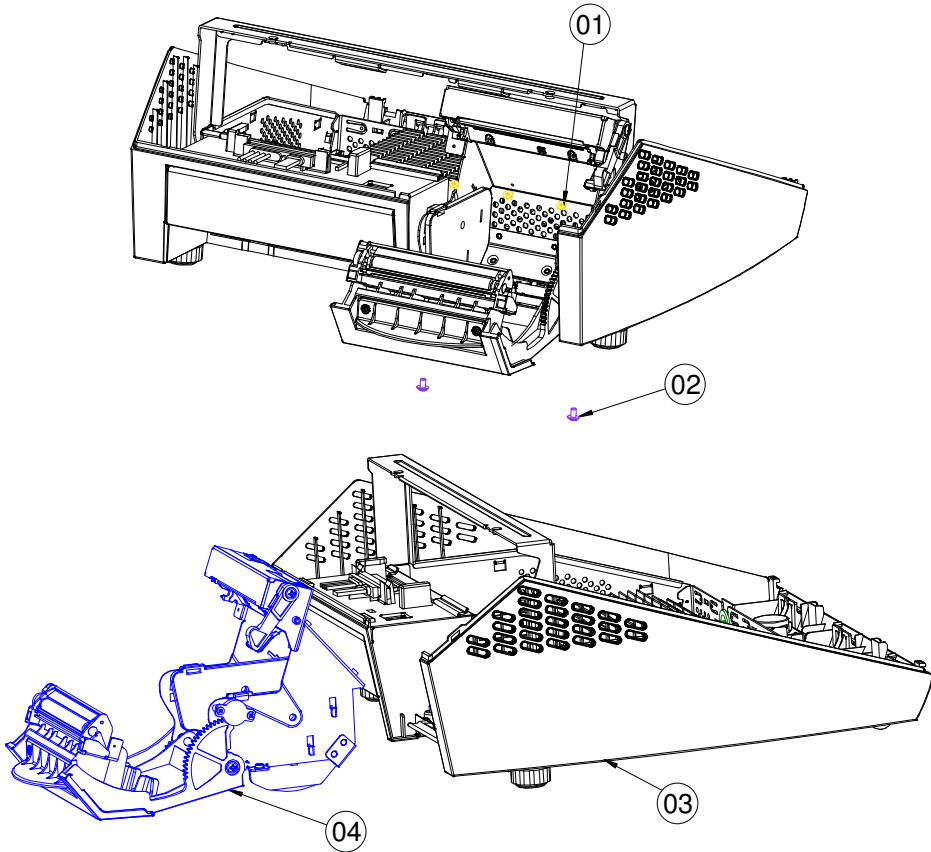

NO.	COMPONENT NAME	PART NO.	Q'TY
1	SCREW	22-222-30004011	3
2	SCREW	22-242-30005311	3
3	BOTTOM CASE ASSY 2	**-*-**-*	1
4	PRINTER_ASSY	**-*-**-*	1



2 Inch Printer

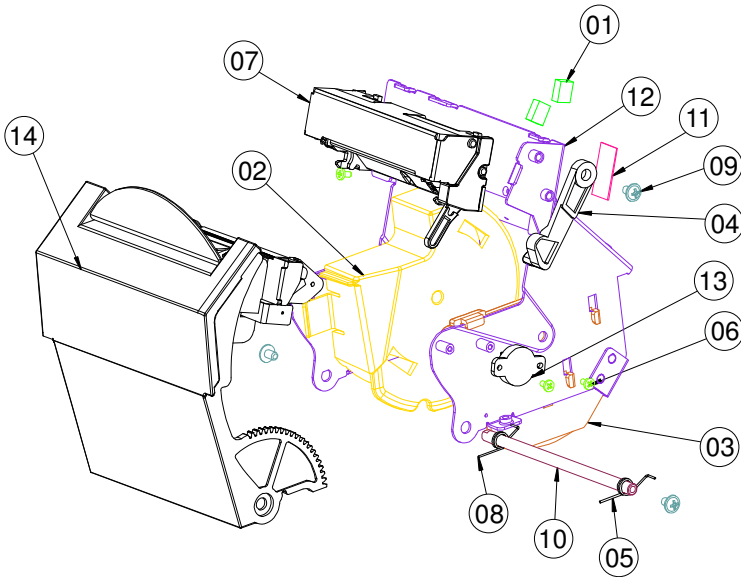

NO.	COMPONENT NAME	PART NO.	Q'TY
1	EMI SHIELDING GASKET	90-050-31100000	2
2	PRINTER 2IN PAPER WALL	30-002-28310199	1
3	3IN SIDE WALL R	30-002-28610199	1
4	PRINTER ADD ARM	30-002-09110199	1
5	PRINTER COVER SPRING R	23-000-00000502	1
6	SCREW	22-272-20004011	3
7	2IN PRINTER MOUDULE A	52-701-00020003	1
8	PRINTER COVER SPRING L	23-000-01000502	1
9	SCREW	22-242-30005311	3
10	PAPER COVER PIN	20-045-19011199	1
11	PC SHEET	90-056-02100199	1
12	PRINTER BOX3 ASSY	20-040-03002199	1
13	ROTARY DAMPER	30-002-09110000	1
14	2IN PRINTER COVER ASSY	***-***-*****	1

2 Inch Printer Cover

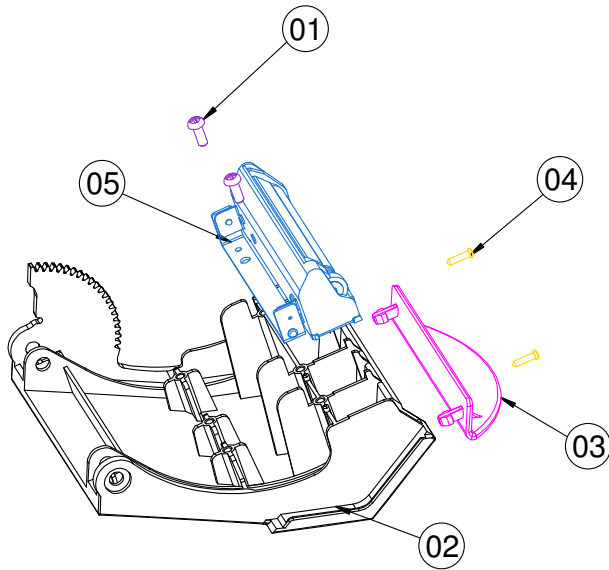

NO.	COMPONENT NAME	PART NO.	Q'TY
1	SCREW	22-122-30080011	2
2	PRINTER DOOR	30-007-28210199	1
3	PAPER HOLDER	30-012-02110165	1
4	SCREW	22-125-20008011	2
5	2IN PRINTER MOUDULE B	52-701-00020003	1

3 Inch Printer

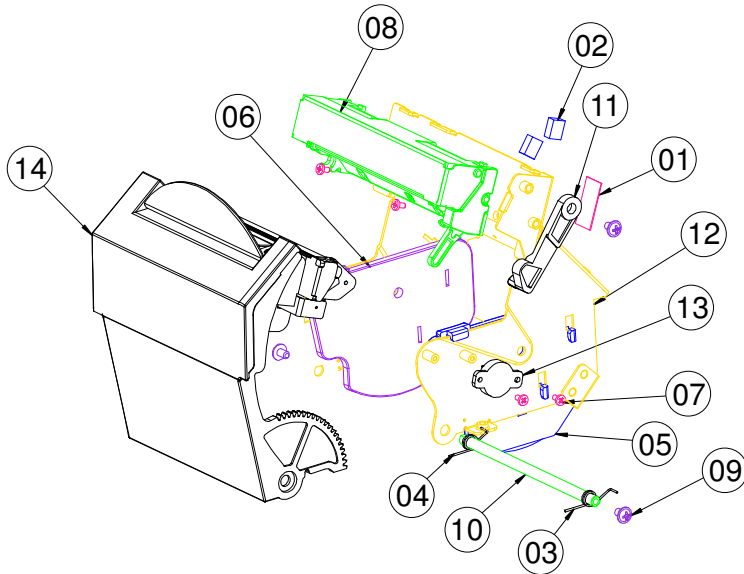

NO.	COMPONENT NAME	PART NO.	Q'TY
1	PC SHEET	90-056-02100199	1
2	EMI SHIELDING GASKET	90-050-31100000	2
3	PRINTER COVER SPRING R	23-000-00000502	1
4	PRINTER COVER SPRING L	23-000-01000502	1
5	3IN SIDE WALL R	30-002-28610199	1
6	3IN SIDE WALL L	30-002-28710199	1
7	SCREW	22-272-20004011	4
8	3IN PRINTER MOUDULE A	52-701-00017003	1
9	SCREW	22-242-30005311	3
10	PAPER COVER PIN	20-045-19011199	1
11	PRINTER ADD ARM	30-002-09110199	1
12	PRINTER BOX3 ASSY	20-040-03002199	1
13	ROTARY DAMPER	30-002-09110000	1
14	3IN PRINTER COVER ASSY	***-***-*****	1

3 Inch Printer Cover

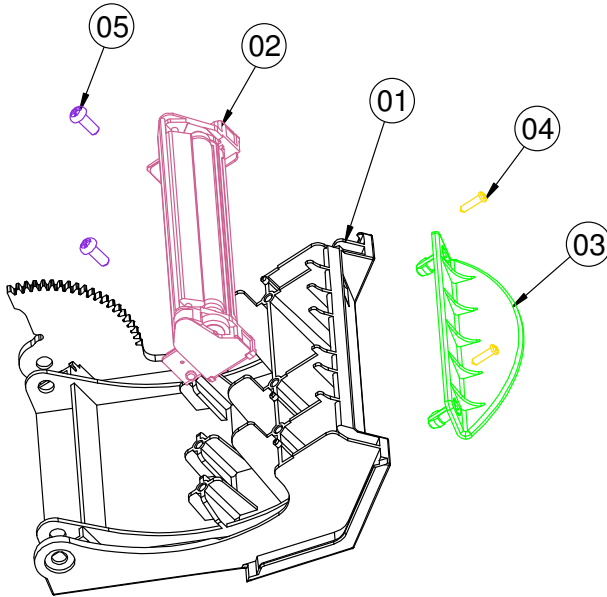

NO.	COMPONENT NAME	PART NO.	Q'TY
1	PRINTER DOOR	30-007-28210199	1
2	3IN PRINTER MOUDULE B	52-701-00017003	1
3	PAPER HOLDER	30-012-02110165	1
4	SCREW	22-125-20008011	2
5	SCREW	22-122-30080011	2