

USER MANUAL

SA-5700

Desktop CPU Book-Sized PC

Powered by Intel® 7th/6th Gen. Core™
With 2DVI, 4COM and 2LAN

SA-5700 M5

SA-5700

Desktop CPU Book-Sized PC

with Intel[®] 7th/6th Gen. Core

COPYRIGHT NOTICE & TRADEMARK

All trademarks and registered trademarks mentioned herein are the property of their respective owners.

This manual is copyrighted in Mar. 2021. You may not reproduce or transmit in any form or by any means, electronic, or mechanical, including photocopying and recording.

DISCLAIMER

This user's manual is meant to assist users in installing and setting up the system. The information contained in this document is subject to change without any notice.

CE NOTICE

This is a class A product. In a domestic environment this product may cause radio interference in which case the user may be required to take adequate measures.

FCC NOTICE

This equipment has been tested and found to comply with the limits for a Class A digital device, pursuant to part 15 of the FCC Rules. These limits are designed to provide reasonable protection against harmful interference when the equipment is operated in a commercial environment. This equipment generates, uses, and can radiate radio frequency energy and, if not installed and used in accordance with the instruction manual, may cause harmful interference to radio communications. Operation of this equipment in a residential area is likely to cause harmful interference in which case the user will be required to correct the interference at his own expense.

You are cautioned that any change or modifications to the equipment not expressly approve by the party responsible for compliance could void your authority to operate such equipment.

	<p>CAUTION: Danger of explosion may occur when the battery is incorrectly replaced. Replace the battery only with the same or equivalent type recommended by the manufacturer. Dispose of used batteries according to the manufacturer's instructions.</p>
--	---

	<p>WARNING: Some internal parts of the system may have high electrical voltage. We strongly recommend that only qualified engineers are allowed to service and disassemble the system. If any damages should occur on the system and are caused by unauthorized servicing, it will not be covered by the product warranty.</p>
---	---

Contents

Revision History	vi
1 Introduction	1-1
1.1 About This Manual	1-2
2 Getting Started	2-1
2.1 Package List.....	2-2
2.2 System Overview	2-3
2.2.1 Front View	2-3
2.2.2 Rear View	2-3
2.2.3 Top View	2-3
2.2.4 Bottom View.....	2-4
2.2.5 Side View	2-4
2.2.6 Quarter View	2-4
2.3 System Specifications	2-5
2.4 Safety Precautions	2-6
3 System Configuration.....	3-1
3.1 External I/O Ports Diagram	3-2
3.1.1 Rear I/O Ports Diagram	3-2
3.2 JUMPER & CONNECTOR QUICK REFERENCE TABLE	3-3
3.3 COMPONENT LOCATIONS	3-5
3.3.1 Top View and Jumper Settings of Main Board BM-2502....	3-5
3.3.2 Bottom View of Main Board BM-2502.....	3-6
3.4 Setting Jumpers	3-7
3.5 Setting Main Board Connectors and Jumpers	3-9

3.5.1	COM1, COM2, COM4 Port Pin9 Definition Selection Guide ...	3-9
3.5.2	COM Ports	3-10
3.5.3	COM1 RS-232/422/485 Selection	3-13
3.5.4	COM1 RS-485 Auto Flow Selection.....	3-14
3.5.5	LAN and USB 3.0 Ports	3-15
3.5.6	LAN2 Port Enable Selection	3-17
3.5.7	4 x 1 USB 2.0 Connectors	3-18
3.5.8	Internal USB 2.0 Connector.....	3-19
3.5.9	Dual DVI-D Ports	3-20
3.5.10	DisplayPort Connector (Optional).....	3-22
3.5.11	HD Audio Connector	3-23
3.5.12	Printer Port Connector (Optional)	3-24
3.5.13	Front Panel Connector.....	3-25
3.5.14	CPU Fan Connector.....	3-26
3.5.15	System Fan Connector	3-26
3.5.16	Half-Sized Mini PCI Express Slots.....	3-27
3.5.17	PCI Express Slots	3-28
3.5.18	SATA 3.0 Connectors	3-30
3.5.19	ATX Power Connectors.....	3-31
3.5.20	AT / ATX Mode Selection	3-32
3.5.21	SPI Connector.....	3-33
3.5.22	SPI Override Protection Selection	3-33
3.5.23	Case Open Detection Connector.....	3-34
3.5.24	Intruder Detection Selection	3-34
3.5.25	Low Pin Count (LPC) Connector	3-35
3.5.26	Clear RTC Data Selection.....	3-35
3.5.27	VCCIO Voltage Selection.....	3-36
3.5.28	BIOS Recovery Mode Selection	3-37

3.5.29	Clear CMOS Data Selection	3-38
4	Software Utilities	4-1
4.1	Introduction.....	4-2
4.2	Installing Intel® Chipset Software Installation Utility.....	4-6
4.2.1	Introduction	4-6
4.2.2	Intel® Chipset Software Installation Utility.....	4-6
4.3	Intel® Management Engine Components Installer Installation ...	4-7
4.4	Intel® USB 3.0 eXtensible Host Controller Utility	4-8
4.5	Installing RAID Driver Utility (Only for Q170, Optional)	4-9
4.6	Installing Graphics Driver Utility	4-11
4.7	Installing LAN Driver Utility.....	4-12
4.8	Installing Sound Driver Utility	4-13
5	BIOS SETUP	5-1
5.1	Introduction.....	5-2
5.2	Accessing Setup Utility.....	5-3
5.3	Main.....	5-7
5.4	Advanced	5-9
5.4.1	Advanced – CPU Configuration.....	5-10
5.4.2	Advanced – SATA Configuration.....	5-12
5.4.3	Advanced – PCH-FW Configuration	5-13
5.4.4	Advanced – ACPI Settings.....	5-14
5.4.5	Advanced – F81866 Super IO Configuration.....	5-15
5.4.6	Advanced – Hardware Monitor	5-23
5.4.6.1	Advanced – Hardware Monitor – Smart Fan Mode Configuration	5-24

5.4.7	Advanced – F81866 Watchdog Configuration	5-25
5.4.8	Advanced – Network Stack Configuration	5-26
5.4.9	Advanced – USB Configuration	5-27
5.5	Chipset	5-28
5.5.1	Chipset – System Agent (SA) Configuration	5-29
5.5.1.1	Chipset – SA Configuration – Memory Configuration..	5-30
5.5.1.2	Chipset – System Agent (SA) Configuration – Graphics Configuration	5-32
5.5.1.3	Chipset –System Agent (SA) Configuration – PEG Port Configuration	5-34
5.5.2	Chipset – PCH-IO Configuration.....	5-35
5.5.2.1	Chipset – PCH-IO Configuration – PCI Express Configuration	5-36
5.6	Security	5-38
5.7	Boot	5-40
5.7.1	Boot – CSM Configuration	5-42
5.8	Save & Exit.....	5-44
Appendix A System Diagrams		A-1
	SA-5700 System Exploded Diagram	A-2
	SA-5700 CPU Heat Sink Exploded Diagram.....	A-4
	SA-5700 SATA HDD Exploded Diagram	A-5
Appendix B Technical Summary		B-1
	System Block Diagram	B-2
	Interrupt Map	B-3
	I/O MAP	B-20
	DMA Channels Map.....	B-22

Memory Map.....	B-23
Configuring WatchDog Timer	B-25
Flash BIOS Update.....	B-27

List of Figures

Figure 3-1. Main Board Component Location (Top View)	3-5
Figure 3-2. Main Board Component Location (Bottom View).....	3-6
Figure 5-1. Extensible Firmware Interface Diagram	5-2
Figure 5-2. POST Screen with AMI Logo.....	5-4

Revision History

The revision history of SA-5700 User Manual is described below:

Version No.	Revision History	Page No.	Date
M1	Initial Release	-	2017/03/10
M2	Revised Section 4.5 Installing RAID Driver Utility (Only for Q170, Optional).	4-9	2017/06/14
	The SA-5700 System Exploded Diagram has been revised.	A-2 to A-3	
	The SA-5700 CPU Heat Sink Exploded Diagram has been revised.	A-4	
	The Flash BIOS Update section in Appendix B has been revised.	B-27 to B-30	
M3	Corrected “DOS” title name to “ Shell ” in the driver locations table of Chapter 4 Software Utilities.	4-2	2017/10/24
	Remove the “BIOS Message” section in Chapter 5 BIOS Setup.	5-6	
M4	In System Specifications section, the Power Supply specification item was modified from ATX 220W to ATX 270W .	2-5	2018/10/05
	The description for the Power Supply part in SA-5700 System Exploded Diagram has been changed from ATX 220W POWER Supply to ATX 270W POWER Supply.	A-3	
M5	Revised the diagram of Top View and Jumper Settings of Main Board BM-2502.	3-5	2021/03/02

1

Introduction

This chapter provides the introduction for the SA-5700 system as well as the framework of the user manual.

The following topic is included:

- About This Manual

1.1 About This Manual

Thank you for purchasing our SA-5700 system. The SA-5700 is an updated system designed to be comparable with the highest performance of IBM AT personal computers. The SA-5700 provides faster processing speed, greater expandability and can handle more tasks than before. This manual is designed to assist you how to install and set up the whole system. It contains 5 chapters and 2 appendixes. Users can configure the system according to their own needs. This user manual is intended for service personnel with strong hardware background. It is not intended for general users.

The following section outlines the structure of this user manual.

Chapter 1 Introduction

This chapter introduces you to the background of this manual.

Chapter 2 Getting Started

This chapter describes the package contents and outlines the system specifications. It also includes the physical illustrations for the SA-5700 system. Read the safety reminders carefully on how to take care of your system properly.

Chapter 3 System Configuration

This chapter outlines the locations of the motherboard components and their respective functions. You will learn how to set the jumpers and configure the system to meet your own needs.

Chapter 4 Software Utilities

This chapter contains helpful information for proper installations of the Intel Chipset Software Installation Utility, Intel Management Engine Components Installer Driver Utility, Intel USB 3.0 Extensible Host Controller Driver Utility, RAID Driver Utility (optional, only for Q170 SKU), Graphics Driver Utility, LAN Driver Utility and Sound Driver Utility.

Chapter 5 AMI BIOS Setup

This chapter indicates you how to change the BIOS configurations.

Appendix A System Assembly Diagrams

This appendix provides the system exploded diagrams and part numbers of SA-5700.

Appendix B Technical Summary

This appendix provides the information about the system block diagram, allocation maps for system resources, Watchdog Timer Configuration and Flash BIOS Update.

2 Getting Started

This chapter provides the information for the SA-5700 system. It describes how to set up the system quickly and outlines the system specifications.

The following topics are included:

- Package List
- System Overview
- System Diagrams
- System Specification
- Safety Precautions

Experienced users can go to Chapter 3 System Configuration on page 3-1 for a quick start.

2.1 Package List

If you discover any of the items listed below are damaged or lost, please contact your local distributor immediately.

Item	Q'ty
SA-5700	1
Manual / Driver DVD	1
Quick Guide	1
Mini Jumper (2 mm)	6
AC Power Cord	1

2.2 System Overview

Unit: mm

2.2.1 Front View

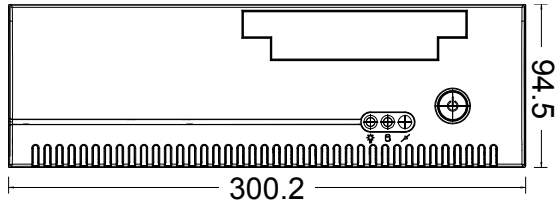

2.2.2 Rear View

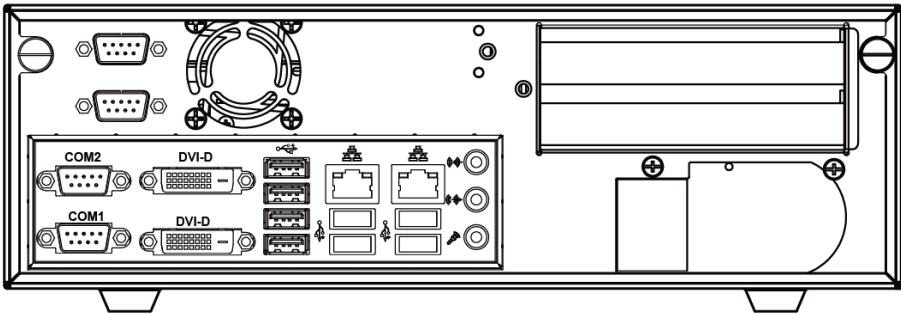

2.2.3 Top View

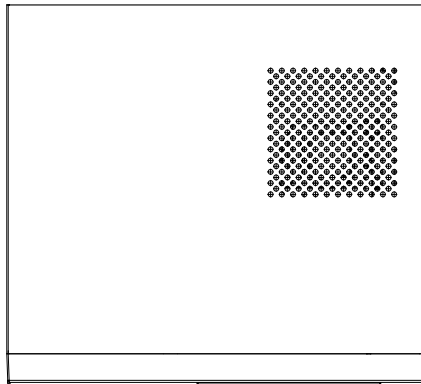

2.2.4 Bottom View



2.2.5 Side View

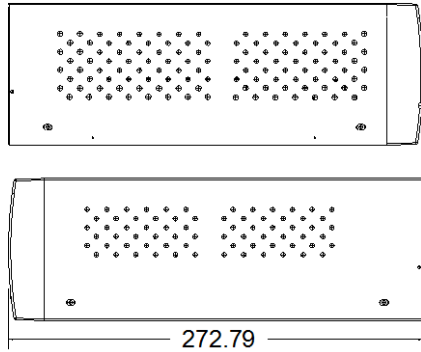

2.2.6 Quarter View

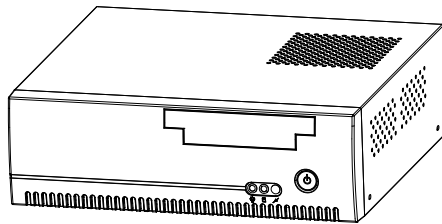

2.3 System Specifications

System	
CPU Support	➤ Intel® 6 th / 7 th Gen. Core™ i3/i5/i7/ Pentium® / Celeron® processor (LGA1151)
Chipset	➤ Intel® H110 / Q170
Memory Support	➤ 2 x DDR4 SO-DIMM sockets (up to 32GB)
Power Supply	➤ ATX 270W
Expansion Slots	➤ 1 x PCIe (x16) slot ➤ 1 x mini PCIe slot
Drive Bay	➤ 2 x 2.5" SATA HDDs ➤ 2 x 2.5" SSDs (optional)
Operating System	➤ Win 7 / Win 8.1 / Win 10 IoT LTSC 2016 / Ubuntu 16.04
System Weight	➤ 5 kg
Dimensions (W x H x D)	➤ 300 x 94 x 270 mm
Certificate	➤ FCC / CE
I/O Ports	
Display	➤ 2 x DVI-D ➤ 1 x DP (optional)
USB	➤ 4 x USB 3.0 ➤ 4 x USB 2.0
Audio	➤ Line-in, Line-out, Mic-in
LAN	➤ 2 x GbE LANs support Wake-on-LAN, PXE ➤ LAN1: Intel® I219 LM ➤ LAN2: Intel® I210 AT
Serial Port	➤ COM1 for RS-232/422/485 ➤ COM2/COM3/COM4 for RS-232 ➤ COM1/COM2/COM4 support +5V / +12V / RI selectable ➤ COM5/COM6 for RS-232 (optional)
Parallel Port	➤ 1 x parallel port (optional)
Environment	
Operating Temperature	➤ HDD: 0°C ~ 40°C (32°F~ 104°F)
Storage Temperature	➤ -20°C ~ 80°C (-4°F~ 176°F)
Humidity	➤ 20%~ 90%

Note: Intel® 7th generation CPU is NOT compatible with Win 7 / Win 8.1.

2.4 Safety Precautions

Before operating this system, read the following information carefully to protect your systems from damages, and extend the life cycle of the system.

1. Check the Line Voltage
 - The operating voltage for the power supply should be within the range of 100V to 240V AC; otherwise the system may be damaged.
2. Environmental Conditions
 - Place your SA-5700 on a sturdy, level surface. Be sure to allow enough space around the system to have easy access needs.
 - Avoid installing your SA-5700 system in extremely hot or cold places.
 - Avoid direct sunlight exposure for a long period of time (for example, in a closed car in summer time. Also avoid the system from any heating device.). Or do not use SA-5700 when it has been left outdoors in a cold winter day.
 - Avoid moving the system rapidly from a hot place to a cold place, and vice versa, because condensation may occur inside the system.
 - Protect your SA-5700 from strong vibrations which may cause hard disk failure.
 - Do not place the system too close to any radio-active device. Radio-active device may cause signal interference.
 - Always shut down the operating system before turning off the power.
3. Handling
 - Avoid placing heavy objects on the top of the system.
 - Do not turn the system upside down. This may cause the hard drive to malfunction.
 - Do not allow any objects to fall into this device.
 - If water or other liquid spills into the device, unplug the power cord immediately.
4. Good Care
 - When the outside case gets stained, remove the stains using neutral washing agent with a dry cloth.
 - Never use strong agents such as benzene and thinner to clean the surface of the case.
 - If heavy stains are present, moisten a cloth with diluted neutral washing agent or alcohol and then wipe thoroughly with a dry cloth.
 - If dust is accumulated on the case surface, remove it by using a special vacuum cleaner for computers.

3

System Configuration

This chapter contains helpful information about the external I/O Ports diagram, and jumper & connector settings, and component locations for the main board.

The following topics are included:

- External I/O Ports Diagram
- Main Board Jumper Settings and Component Locations
- How to Set Jumpers
- Setting Main Board Connectors and Jumpers

3.1 External I/O Ports Diagram

3.1.1 Rear I/O Ports Diagram

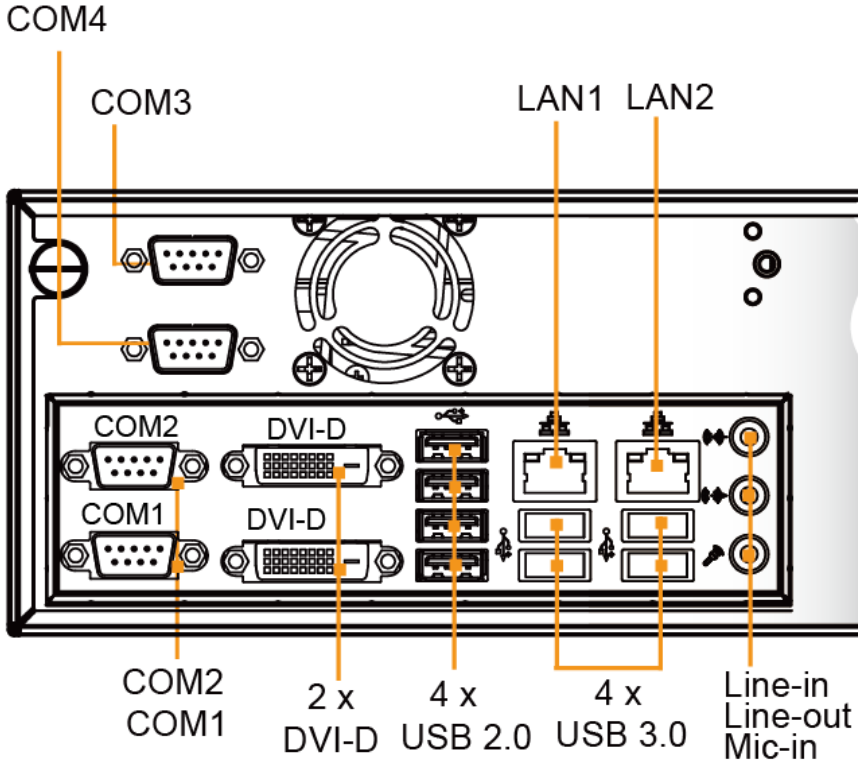

3.2 JUMPER & CONNECTOR QUICK REFERENCE TABLE

JUMPER Description	NAME
Clear CMOS Data Selection	JCMOS1
COM1 Pin9 RI/5V/12V Selection	JP_COM1
COM2 Pin9 RI/5V/12V Selection	JP_COM2
COM4 Pin9 RI/5V/12V Selection	JP_COM4
LAN2 Port Enable Selection	JP_LAN2
VCCIO Voltage Selection	JP1
AT / ATX Mode Selection	JP2 & JP3
Intruder Detection Selection	JP4
BIOS Recovery Mode Selection	JP5
COM1 RS-232/422/485 Selection	JP6
SPI Override Protection Selection	JP9
COM1 RS-485 Auto Flow Selection	JP11
Clear RTC Data Selection	JRTC1

CONNECTOR Description	NAME
COM Ports	COM1, COM2, COM3, COM4
COM3, COM4 Pin Headers	COM3, COM4
(Optional) COM5, COM6 Ports	COM5, COM6
(Optional) COM5, COM6 Pin Headers	COM5, COM6
2 x LAN Ports and 4 x USB 3.0 Ports	LAN1_USB1, LAN2_USB2
4 x 1 USB 2.0 Connectors	USB1
Internal USB 2.0 Connector	USB2
2 x DVI-D Connectors	DVI1
(Optional) Display Connector	DP1
HD Audio Connector	AUDIO1
(Optional) Printer Port (LPT) Connector	LPT1
Front Panel Connector	FP1
CPU Fan Connector	CPU_FAN1
System Fan Connector	SYS_FAN1
Half-Sized Mini PCI Express Slots	M_PCIE1
PCI Express Slots (PCIe (x16))	PCI_E1

CONNECTOR Description	NAME
SATA 3.0 Connectors	SATA1, SATA2
ATX Power Input Connectors	ATX_PWR1, ATX_PWR2
SPI Connector	JP7
Case Open Detection Connector	JP10
Low Pin Count (LPC) Connector	JP12
DDR4 SO-DIMM memory socket	SO-DIMM1
DDR4 SO-DIMM memory socket	SO-DIMM2

3.3 COMPONENT LOCATIONS

3.3.1 Top View and Jumper Settings of Main Board BM-2502

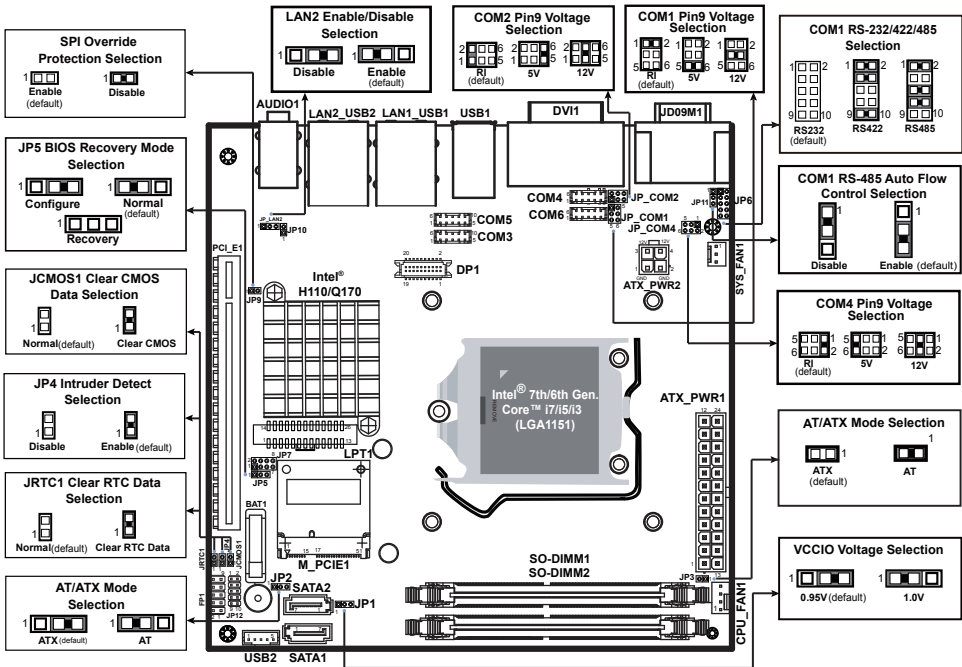

Figure 3-1. Main Board Component Location (Top View)

	<p>WARNING: Always disconnect the power cord when you are working with connectors and jumpers on the main board. Make sure both the system and peripheral devices are turned OFF as sudden surge of power could damage sensitive components. Make sure the main board is properly grounded.</p>
	<p>CAUTION: Observe precautions while handling electrostatic sensitive components. Make sure to ground yourself to prevent static charge while you are working on the connectors and jumpers. Use a grounding wrist strap and place all electronic components in any static-shielded devices.</p>



CAUTION: Always touch the motherboard components by the edges. Never touch components such as a processor by its pins. Take special care while you are holding electronic circuit boards by the edges only. Do not touch the mainboard components.

3.3.2 Bottom View of Main Board BM-2502

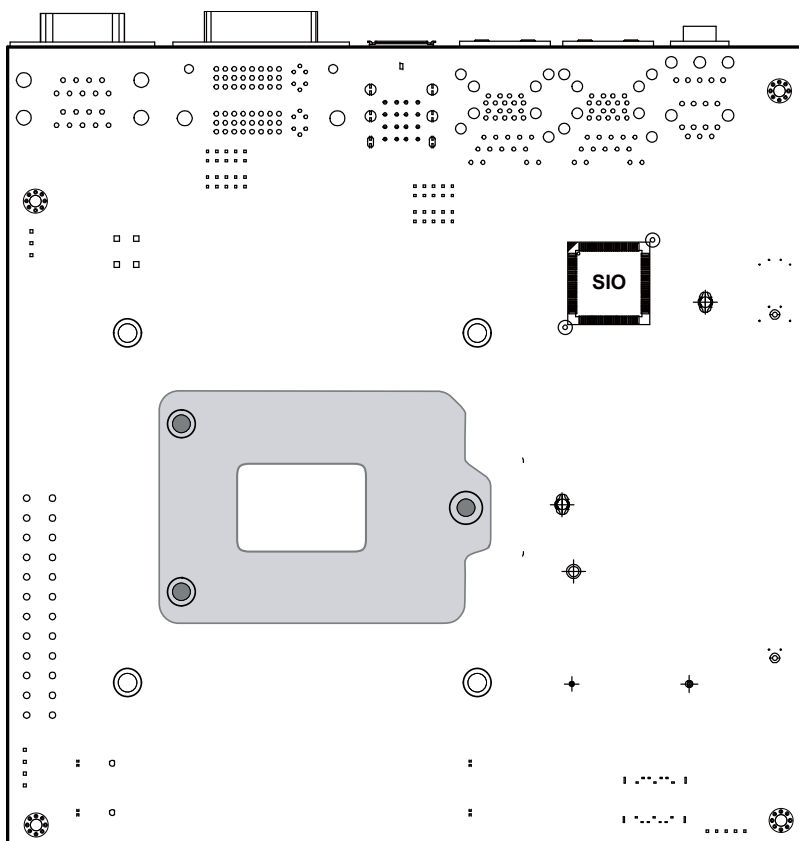

Figure 3-2. Main Board Component Location (Bottom View)

3.4 Setting Jumpers

You can configure your board by setting the jumpers. A jumper consists of two or three metal pins with a plastic base mounted on the card. By using a small plastic "cap", also known as the jumper cap (with a metal contact inside), you are able to connect the pins. So you can configure your hardware settings by "opening" or "closing" jumpers.

Jumpers can be combined into sets that are called jumper blocks. When jumpers are all in the block, you have to put them together to set up the hardware configuration. The figure below shows what this looks like.

Jumpers & Caps

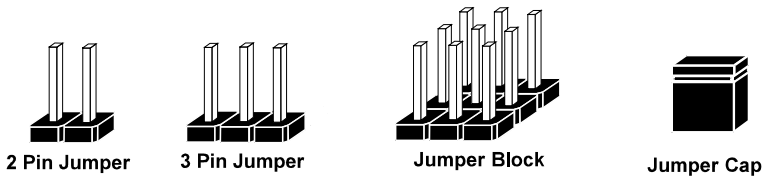

If a jumper has three pins, for example, labeled 1, 2 and 3. You can connect pins 1 and 2 to create one setting and shorting. You can also select to connect pins 2 and 3 to create another setting. The format of the jumper picture will be illustrated throughout this manual. The figure below shows different types of jumpers and jumper settings.

Jumper diagrams



Jumper Cap looks like this

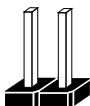

2 pin Jumper looks like this

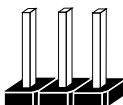

3 pin Jumper looks like this

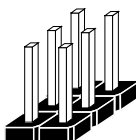

Jumper Block looks like this

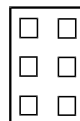

Jumper settings



2 pin Jumper closed(enabled)
looks like this

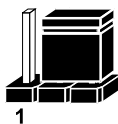

3 pin Jumper
2-3 pin closed(enabled)
looks like this

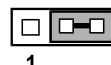

Jumper Block
1-2 pin closed(enabled)
looks like this

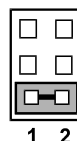

3.5 Setting Main Board Connectors and Jumpers

3.5.1 COM1, COM2, COM4 Port Pin9 Definition Selection Guide

Jumper Location: JP_COM1 & JP_COM2 & JP_COM4

Description: COM1, COM2 and COM4 Port pin9 RI/+5V/+12V Selection

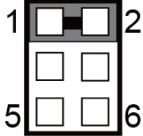
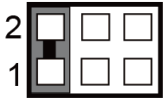
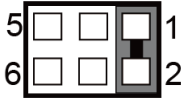
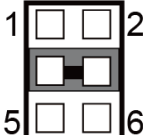
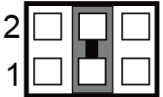
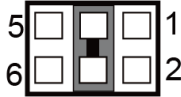
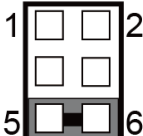
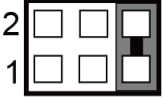
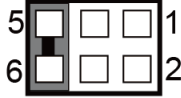
SELECTION	JUMPER SETTING	JUMPER ILLUSTRATION		
		JP_COM1	JP_COM2	JP_COM4
RI	1-2 (Default Setting)	 <p>JP_COM1</p>	 <p>JP_COM2</p>	 <p>JP_COM4</p>
12V	3-4	 <p>JP_COM1</p>	 <p>JP_COM2</p>	 <p>JP_COM4</p>
5V	5-6	 <p>JP_COM1</p>	 <p>JP_COM2</p>	 <p>JP_COM4</p>

3.5.2 COM Ports

COM1(RS-232/422/485) Connector Pin Assignment:

PIN	ASSIGNMENT		
	RS-232	RS-422	RS-485
1	DCD#	TX-	RS-485-
2	RX	TX+	RS-485+
3	TX	RX+	X
4	DTR#	RX-	X
5	GND	GND	GND
6	DSR#	X	X
7	RTS#	X	X
8	CTS#	X	X
9	RI#	X	X

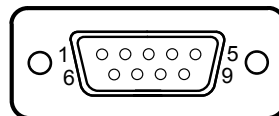

COM1

Notes:

1. COM1 is selectable as RS-232, RS-422, RS-485 by JP6.
2. Default setting is RS-232. Please see “**COM1 RS-232/422/485 Selection**” section for details.
3. COM1 Pin 9 is selectable for RI, +5V or +12V by jumper setting. Default setting is RI. Please see “**COM1, COM2, COM4 Port Pin9 Definition Selection Guide**” section for selection details.

COM2(RS-232) Connector Pin Assignment:

PIN	ASSIGNMENT	PIN	ASSIGNMENT
1	DCD#	6	DSR#
2	RX	7	RTS#
3	TX	8	CTS#
4	DTR#	9	RI#
5	GND	-	-

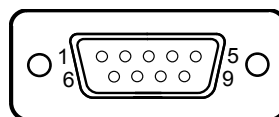

COM2

Note:

1. COM2 Pin 9 is selectable for RI, +5V or +12V by jumper setting. Default setting is RI. Please see “**COM1, COM2, COM4 Port Pin9 Definition Selection Guide**” section for selection details.

COM3(RS-232), COM4(RS-232) Connector Pin Assignment:

PIN	ASSIGNMENT	PIN	ASSIGNMENT
1	DCD#	6	DSR#
2	RX	7	RTS#
3	TX	8	CTS#
4	DTR#	9	RI#
5	GND	-	-

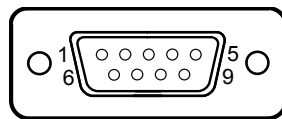

**COM3/
COM4**

Note:

- COM4 Pin 9 is selectable for RI, +5V or +12V by jumper setting. Default setting is RI. Please see “COM1, COM2, COM4 Port Pin9 Definition Selection Guide” section for selection details.

COM3(RS-232), COM4(RS-232) Connector Pin Header Pin Assignment:

PIN	ASSIGNMENT	PIN	ASSIGNMENT
1	DCD#	6	DSR#
2	RX	7	RTS#
3	TX	8	CTS#
4	DTR#	9	RI#
5	GND	10	NC

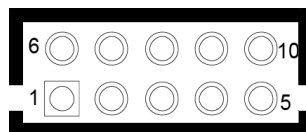

**COM3/
COM4
Pin Header**

(Optional) COM5(RS-232), COM6 (RS-232) Connector Pin Assignment:

PIN	ASSIGNMENT	PIN	ASSIGNMENT
1	DCD#	6	DSR#
2	RX	7	RTS#
3	TX	8	CTS#
4	DTR#	9	RI#
5	GND	-	-

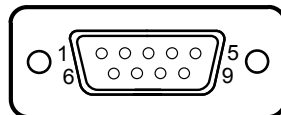

**COM5/
COM6
(optional)**

(Optional) COM5(RS-232),COM6 (RS-232) Connector Pin Header Pin Assignment:

PIN	ASSIGNMENT	PIN	ASSIGNMENT
1	DCD#	6	DSR#
2	RX	7	RTS#
3	TX	8	CTS#
4	DTR#	9	RI#
5	GND	10	NC

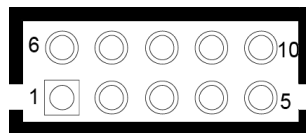

**COM5/
COM6
Pin Header
(optional)**

3.5.3 COM1 RS-232/422/485 Selection

Jumper Location: JP6

Description: COM1 RS-232/422/485 Selection

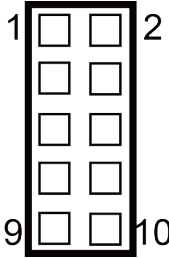
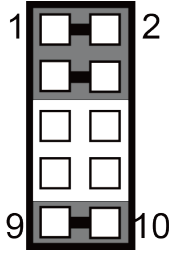
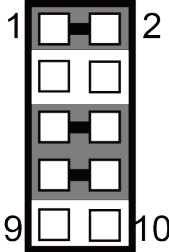
SELECTION	JUMPER SETTINGS	JUMPER ILLUSTRATION
RS-232	<i>Open (Default Setting)</i>	 <p style="text-align: center;">JP6</p>
RS-422	1-2, 3-4, 9-10	 <p style="text-align: center;">JP6</p>
RS-485	1-2, 5-6, 7-8	 <p style="text-align: center;">JP6</p>

3.5.4 COM1 RS-485 Auto Flow Selection

Jumper Location: JP11

Description: COM1 RS-485 Auto Flow Selection

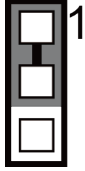
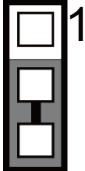
SELECTION	JUMPER SETTINGS	JUMPER ILLUSTRATION
Disable	1-2	 <p>JP11</p>
Enable	2-3 <i>(Default Setting)</i>	 <p>JP11</p>

3.5.5 LAN and USB 3.0 Ports

Port Name: LAN1_USB1 (rear I/O)

Description: LAN1 & Dual USB 3.0 Ports

LAN1 signals:

PIN	ASSIGNMENT	PIN	ASSIGNMENT
1	MDI_0P	5	MDI_2N
2	MDI_0N	6	MDI_1N
3	MDI_1P	7	MDI_3P
4	MDI_2P	8	MDI_3N

LAN LED Indicator:

Left Side LED

Green Color On	10/100Mbps LAN Speed Indicator
Orange Color On	Giga LAN Speed Indicator
Off	No LAN switch/hub connected

Right Side LED

Yellow Color Blinking	LAN Message Active
Off	No LAN Message Active

Green/Orange Yellow

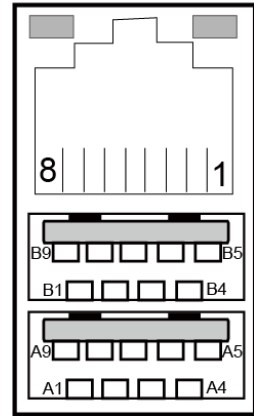

LAN1_USB1

USB 3.0 signals:

PIN	ASSIGNMENT	PIN	ASSIGNMENT
A1	VCC5	B1	VCC5
A2	USBP1N	B2	USBP2N
A3	USBP1P	B3	USBP2P
A4	GND	B4	GND
A5	RX1_DN	B5	RX2_DN
A6	RX1_DP	B6	RX2_DP
A7	GND	B7	GND
A8	TX1_DN	B8	TX2_DN
A9	TX1_DP	B9	TX2_DP

Port Name: LAN2_USB2 (rear I/O)

Description: LAN2 Port & Dual USB3.0 Ports

LAN2 signals:

PIN	ASSIGNMENT	PIN	ASSIGNMENT
1	MDI_0P	5	MDI_2N
2	MDI_0N	6	MDI_1N
3	MDI_1P	7	MDI_3P
4	MDI_2P	8	MDI_3N

LAN LED Indicator:

Left Side LED

Green Color On	10/100Mbps LAN Speed Indicator
Orange Color On	Giga LAN Speed Indicator
Off	No LAN switch/hub connected

Right Side LED

Yellow Color Blinking	LAN Message Active
Off	No LAN Message Active

Green/Orange Yellow

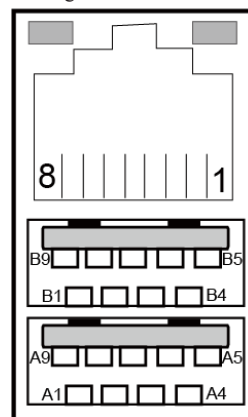

LAN2_USB2



USB 3.0 signals:

PIN	ASSIGNMENT	PIN	ASSIGNMENT
A1	VCC5	B1	VCC5
A2	USBP3N	B2	USBP4N
A3	USBP3P	B3	USBP4P
A4	GND	B4	GND
A5	RX3_DN	B5	RX4_DN
A6	RX3_DP	B6	RX4_DP
A7	GND	B7	GND
A8	TX3_DN	B8	TX4_DN
A9	TX3_DP	B9	TX4_DP

3.5.6 LAN2 Port Enable Selection

Jumper Location: JP_LAN2

Description: LAN2 Port Enable Selection

SELECTION	JUMPER SETTINGS	JUMPER ILLUSTRATION
Enable	1-2 <i>(Default Setting)</i>	 <p>1 JP_LAN2</p>
Disable	2-3	 <p>1 JP_LAN2</p>

3.5.7 4 x 1 USB 2.0 Connectors

Port Name: USB1 (rear I/O)

Description: USB 2.0 Connectors x 4

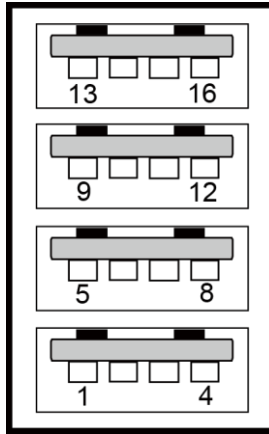

USB1

USB 2.0 signals:

PIN	ASSIGNMENT	PIN	ASSIGNMENT	PIN	ASSIGNMENT	PIN	ASSIGNMENT
4	GND	3	USB2_P5_DP_L	2	USB2_P5_DN_L	1	VCC5
8	GND	7	USB2_P6_DP_L	6	USB2_P6_DN_L	5	VCC5
12	GND	11	USB2_P7_DP_L	10	USB2_P7_DN_L	9	VCC5
16	GND	15	USB2_P8_DP_L	14	USB2_P8_DN_L	13	VCC5

3.5.8 Internal USB 2.0 Connector

Connector Location: USB2

Description: Internal USB 2.0 Connector

USB 2.0 connector signals:

PIN	ASSIGNMENT
1	VCC5
2	USB2_P9_DN_L
3	USB2_P9_DP_L
4	GND
5	GND

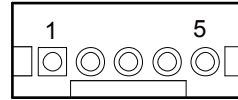

USB2

3.5.9 Dual DVI-D Ports

Port Name: DVI1 (rear I/O)

Description: 2 x DVI (Digital Visual Interface) Integrated Connectors (Supports only DVI-D signals)

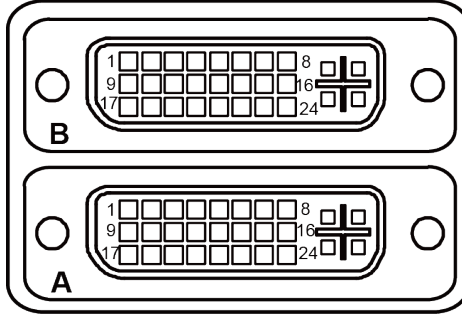

DVI1 connector signals (A):

PIN	ASSIGNMENT	PIN	ASSIGNMENT
A1	DP_Data2-	A13	NC
A2	DP_Data2+	A14	+5V Power
A3	Ground	A15	Ground
A4	NC	A16	HOT Plug Detect
A5	NC	A17	DP_Data0-
A6	DP_Ctrl_Clock	A18	DP_Data0+
A7	DP_Ctrl_Data	A19	Ground
A8	CRT_VSYNC	A20	NC
A9	DP_Data1-	A21	NC
A10	DP_Data1+	A22	Ground
A11	Ground	A23	DP_Clock+
A12	NC	A24	DP_Clock-

DVI-I connector signals (B):

PIN	ASSIGNMENT	PIN	ASSIGNMENT
B1	DP_Data2-	B13	NC
B2	DP_Data2+	B14	+5V Power
B3	Ground	B15	Ground
B4	NC	B16	HOT Plug Detect
B5	NC	B17	DP_Data0-
B6	DP_Ctrl_Clock	B18	DP_Data0+
B7	DP_Ctrl_Data	B19	Ground
B8	CRT_VSYNC	B20	NC
B9	DP_Data1-	B21	NC
B10	DP_Data1+	B22	Ground
B11	Ground	B23	DP_Clock+
B12	NC	B24	DP_Clock-

3.5.10 DisplayPort Connector (Optional)

Connector Location: DP1

Description: DisplayPort Connector

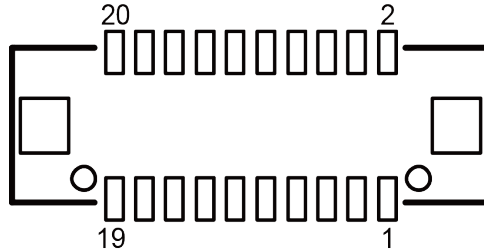

DP1 (optional)

PIN	ASSIGNMENT	PIN	ASSIGNMENT
1	DP_C_DATA0+	2	GND
3	DP_C_DATA0-	4	DP_C_DATA1+
5	GND	6	DP_C_DATA1-
7	DP_C_DATA2+	8	GND
9	DP_C_DATA2-	10	DP_C_DATA3+
11	GND	12	DP_C_DATA3-
13	DP_C_AUX_ENJ	14	GND
15	DP_C_AUX+	16	DP_C_HPD
17	DP_C_AUX-	18	DP_VCC3_3
19	DP_VCC5	20	DP_VCC3_3

3.5.11 HD Audio Connector

Connector Location: AUDIO1

Description: HD Audio Connector for Line_in/Line_out/Mic_in.

Line-in:

PIN	ASSIGNMENT
42	NC
43	NC
44	NC
32	HD_LINE-IN-L
33	GND
34	GND
35	HD_LINE-IN-R

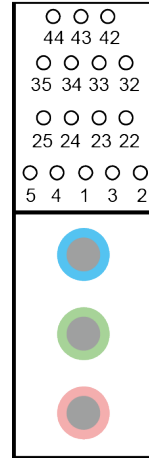

Line-out:

PIN	ASSIGNMENT
22	LINE-OUT-L
23	GND
24	GND
25	LINE-OUT-R

Mic-in:

PIN	ASSIGNMENT
2	HD_MIC1-L_L
3	GND
1	GND
4	GND
5	HD_MIC1-R_L

AUDIO1

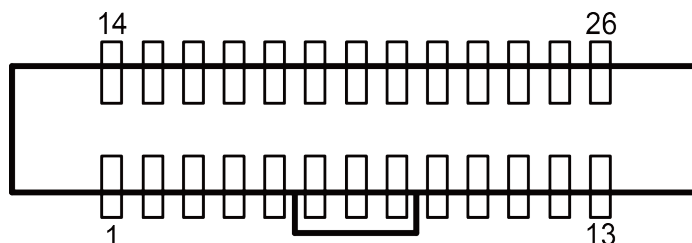
3.5.12 Printer Port Connector (Optional)**Connector Location:** LPT1**Description:** Printer Port Connector**LPT1 (optional)****Printer Port (LPT1) signals:**

PIN	ASSIGNMENT	PIN	ASSIGNMENT
1	STRB#	14	AFD
2	D0	15	ERR#
3	D1	16	INIT
4	D2	17	SLIN
5	D3	18	GND
6	D4	19	GND
7	D5	20	GND
8	D6	21	GND
9	D7	22	GND
10	ACK#	23	GND
11	BUSY	24	GND
12	PE	25	GND
13	SLCT	26	GND

3.5.13 Front Panel Connector

Port Name: FP1

Description: Front Panel Connector

PIN	ASSIGNMENT	PIN	ASSIGNMENT
1	HDD+	2	PWR+
3	HDD-	4	PWR-
5	GND	6	Power Button
7	Reset Button	8	GND
9	5V	-	-

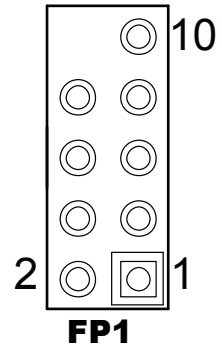

3.5.14 CPU Fan Connector

Connector Location: CPU_FAN1

Description: CPU Fan Connector

CPU Fan Connector (CPU_FAN1) signals:

PIN	ASSIGNMENT
1	GND
2	VCC12
3	TAC
4	CTL

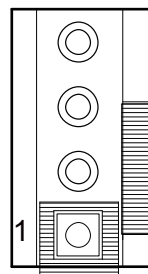

CPU_FAN1

Notes:

1. CPU Fan speed mode can be set by BIOS.
2. Default BIOS setting is “Auto Duty-Cycle Mode”. Please see **Chapter 5** for more details.

3.5.15 System Fan Connector

Connector Location: SYS_FAN1

Description: System Fan Connector

System Fan Connector (SYS_FAN1) signals:

PIN	ASSIGNMENT
1	GND
2	VCC12
3	NC

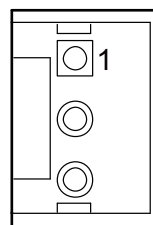

SYS_FAN1

3.5.16 Half-Sized Mini PCI Express Slots

Connector Location: M_PCIE1

Description: Half-Sized Mini-PCI Express Slots

Mini-PCI Express Slot 1 (M_PCIE1) signals:

PIN	ASSIGNMENT	PIN	ASSIGNMENT
1	WAKEJ	2	VCC_3_3_SB
3	NC	4	GND
5	NC	6	VCC1_5
7	CLKREQJ	8	NC
9	GND	10	NC
11	CLK_DN	12	NC
13	CLK_DP	14	NC
15	GND	16	NC
17	NC	18	GND
19	NC	20	NC
21	GND	22	PLTRSTJ_BUF
23	PCIE_RXN	24	VCC3_3_SB
25	PCIE_RXP	26	GND
27	GND	28	VCC1_5
29	GND	30	SMB_CLK
31	PCIE_TXN	32	SMB_DATA
33	PCIE_TXP	34	GND
35	GND	36	USBN
37	GND	38	USBP
39	VCC3_3_SB	40	GND
41	VCC3_3_SB	42	NC
43	GND	44	NC
45	NC	46	NC
47	NC	48	VCC1_5
49	NC	50	GND
51	NC	52	VCC3_3_SB

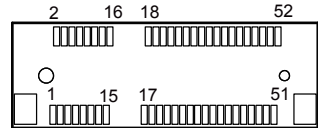

M_PCIE1

Mini PCI Express is the successor of the Mini PCI card and provides an increased data throughput. The cards have a detached network interface and are equipped with one lane. They are used in particular in embedded designs or compact box PCs.

3.5.17 PCI Express Slots

Connector Location: PCI_E1 (PCIE x16)

Description: PCI Express Slots

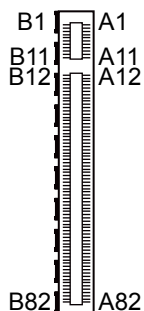

PCI_E1

PIN	ASSIGNMENT	PIN	ASSIGNMENT	PIN	ASSIGNMENT	PIN	ASSIGNMENT
B2	+ 12V	B1	+ 12V	A2	+ 12V	A1	PRST#1
B4	GND	B3	+ 12V	A4	GND	A3	+ 12V
B6	SMB_DATA	B5	SMB_CLK	A6	NC	A5	NC
B8	+ 3.3V	B7	GND	A8	NC	A7	NC
B10	+ 3.3V AXU	B9	NC	A10	+ 3.3V	A9	+ 3.3V
-	-	B11	WAKE#	-	-	A11	PERST#
B12	RSVD	B13	GND	A12	GND	A13	REFCLK+
B14	HSOP0	B15	HSO#0	A14	REFCLK-	A15	GND
B16	GND	B17	PRST#2	A16	HSIP0	A17	HSIN0
B18	GND	B19	HSOP1	A18	GND	A19	RSVD
B20	HSO#1	B21	GND	A20	GND	A21	HSIP1
B22	GND	B23	HSOP2	A22	HSIN1	A23	GND
B24	HSO#2	B25	GND	A24	GND	A25	HSIP2
B26	GND	B27	HSOP3	A26	HSIN2	A27	GND
B28	HSO#3	B29	GND	A28	GND	A29	HSIP3
B30	RSVD	B31	PRST#2	A30	HSIN3	A31	GND
B32	GND	B33	HSOP4	A32	RSVD	A33	RSVD
B34	HSO#4	B35	GND	A34	GND	A35	HSIP4
B36	GND	B37	HSOP5	A36	HSIN4	A37	GND
B38	HSO#5	B39	GND	A38	GND	A39	HSIP5
B40	GND	B41	HSOP6	A40	HSIN5	A41	GND
B42	HSO#6	B43	GND	A42	GND	A43	HSIP6
B44	GND	B45	HSOP7	A44	HSIN6	A45	GND
B46	HSO#7	B47	GND	A46	GND	A47	HSIP7
B48	PRST#2	B49	GND	A48	HSIN7	A49	GND
B50	HSOP8	B51	HSO#8	A50	RSVD	A51	GND
B52	GND	B53	GND	A52	HSIP8	A53	HSIN8
B54	HSOP9	B55	HSO#9	A54	GND	A55	GND
B56	GND	B57	GND	A56	HSIP9	A57	HSIN9
B58	HSOP10	B59	HSO#10	A58	GND	A59	GND
B60	GND	B61	GND	A60	HSIP10	A61	HSIN10

Chapter 3 Hardware Configuration

PIN	ASSIGNMENT	PIN	ASSIGNMENT	PIN	ASSIGNMENT	PIN	ASSIGNMENT
B62	HSOP11	B63	HSOP11	A62	GND	A63	GND
B64	GND	B65	GND	A64	HSIP11	A65	HSIN11
B66	HSOP12	B67	HSOP12	A66	GND	A67	GND
B68	GND	B69	GND	A68	HSIP12	A69	HSIN12
B70	HSOP13	B71	HSOP13	A70	GND	A71	GND
B72	GND	B73	GND	A72	HSIP13	A73	HSIN13
B74	HSOP14	B75	HSOP14	A74	GND	A75	GND
B76	GND	B77	GND	A76	HSIP14	A77	HSIN14
B78	HSIP15	B79	HSIP15	A78	GND	A79	GND
B80	GND	B81	PRSNT#2	A80	HSIP15	A81	HSIN15
B82	RSVD	-	-	A82	GND	-	-

3.5.18 SATA 3.0 Connectors

Connector Location: SATA1

Description: Serial ATA (SATA) 6GB/s Connector

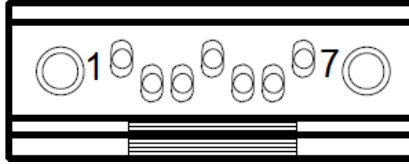

SATA1

Serial ATA 6GB/s Connector (SATA1) signals:

PIN	ASSIGNMENT
1	GND
2	TXPC
3	TXNC
4	GND
5	RXNC
6	RXPC
7	GND

Connector Location: SATA2

Description: Serial ATA (SATA) 6GB/s Connector

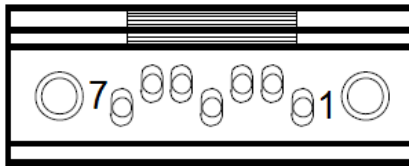

SATA2

Serial ATA 6GB/s Connector (SATA2) signals:

PIN	ASSIGNMENT
1	GND
2	TXPC
3	TXNC
4	GND
5	RXNC
6	RXPC
7	GND

3.5.19 ATX Power Connectors

Connector Location: ATX_PWR1

Description: ATX Power Connector

ATX_PWR1 ATX Power Connector signals:

PIN	ASSIGNMENT	PIN	ASSIGNMENT
1	+3.3V	13	+3.3V
2	+3.3V	14	12V
3	GND	15	GND
4	+5V	16	PSON
5	GND	17	GND
6	+5V	18	GND
7	GND	19	GND
8	PWROK	20	-5V
9	5VSB	21	+5V
10	+12V	22	+5V
11	+12V	23	+5V
12	+3.3V	24	GND

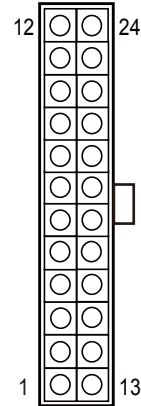

ATX_PWR1

Connector Location: ATX_PWR2

Description: DC Power Input Connector

ATX_PWR2 DC Power Input Connector signals:

PIN	ASSIGNMENT	PIN	ASSIGNMENT
1	GND	3	+12V
2	GND	4	+12V

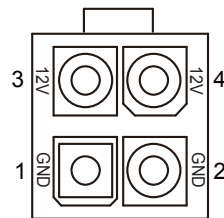



ATX_PWR2

3.5.20 AT / ATX Mode Selection



Jumper Location: JP2

Description: AT / ATX Mode Selection

SELECTION	JUMPTER SETTING	JUMPER ILLUSTRATION
AT	1-2	 JP2
ATX	2-3 <i>(Default Setting)</i>	 JP2

Jumper Location: JP3

Description: AT / ATX Mode Selection

SELECTION	JUMPTER SETTING	JUMPER ILLUSTRATION
AT	Close	 JP3
ATX	Open <i>(Default Setting)</i>	 JP3

3.5.21 SPI Connector

Connector Location: JP7

Description: SPI (Serial Peripheral Interface Bus) Connector

PIN	ASSIGNMENT	PIN	ASSIGNMENT
1	3.3V	2	GND
3	CSJ	4	CLK
5	MISO	6	MOSI
7	NC	8	NC

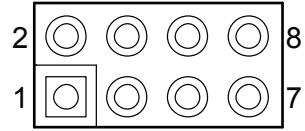



JP7

3.5.22 SPI Override Protection Selection

Jumper Location: JP9

Description: SPI Override Protection Selection

SELECTION	JUMPER SETTING	JUMPER ILLUSTRATION
Enable	<i>Open (Default Setting)</i>	 1 JP9
Disable	Close	 1 JP9

3.5.23 Case Open Detection Connector

Connector Location: JP10

Description: Case Open Detection Connector

PIN	ASSIGNMENT
1	Caseopen+
2	Caseopen-

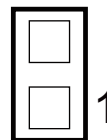

JP10

3.5.24 Intruder Detection Selection

Jumper Location: JP4

Description: Intruder Detection Selection

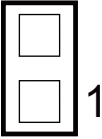
SELECTION	JUMPER SETTING	JUMPER ILLUSTRATION
Enable	<i>Close (Default Setting)</i>	 JP4
Disable	Open	 JP4

3.5.25 Low Pin Count (LPC) Connector

Connector Location: JP12

Description: Low Pin Count (LPC) Connector

PIN	ASSIGNMENT	PIN	ASSIGNMENT
1	CLK	2	GND
3	FRAME#	4	GND
5	PLTRST#	6	LPC_AD0
7	LPC_AD3	8	LPC_AD2
9	3.3V	10	LPC_AD1

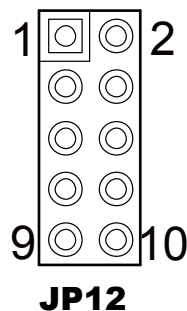

3.5.26 Clear RTC Data Selection

Jumper Location: JRTC1



Description: Clear RTC Data Selection

SELECTION	JUMPER SETTINGS	JUMPER ILLUSTRATION
Normal	<i>Open (Default Setting)</i>	 JRTC1
Clear RTC Data	Close	 JRTC1

3.5.27 VCCIO Voltage Selection

Jumper Location: JP1



Description: VCCIO Voltage Selection

SELECTION	JUMPER SETTING	JUMPER ILLUSTRATION
0.95V	2-3 <i>(Default Setting)</i>	 JP1
1.0V	1-2	 JP1

3.5.28 BIOS Recovery Mode Selection

Jumper Location: JP5

Description: BIOS Recovery Mode Selection



SELECTION	JUMPER SETTING	JUMPER ILLUSTRATION
Normal	1-2 <i>(Default Setting)</i>	 JP5
Configure	2-3	 JP5
Recovery	Open	 JP5

3.5.29 Clear CMOS Data Selection

Jumper Location: JCMOS1

Description: Clear CMOS Data Selection

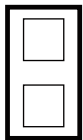
- Step 1. Remove the main power of the PC.
- Step 2. Close **JCMOS1** (pins 1-2) for 6 seconds by a cap.
- Step 3. Remove the cap which is just used on **JCMOS1** (1-2), so that **JCMOS1** returns to “OPEN”.
- Step 4. Power on the PC and the PC will then auto-reboot for once in order to set SoC’s register.
- Step 5. Done!

SELECTION	JUMPER SETTINGS	JUMPER ILLUSTRATION
Normal	<i>Open (Default Setting)</i>	 <p>JCMOS1</p>
Clear CMOS Data	Close	 <p>JCMOS1</p>

Note: Please make sure the main power is off before you clear CMOS.

4 Software Utilities

This chapter provides the detailed information that guides users to install driver utilities for the system. The following topics are included:

- Installing Intel® Chipset Software Installation Utility
- Installing Intel® Management Engine Components Installer
- Installing USB 3.0 eXtensible Host Controller Utility
- Installing RAID Driver Utility (Only for Q170, Optional)
- Installing Graphics Driver Utility
- Installing LAN Driver Utility
- Installing Sound Driver Utility

4.1 Introduction

Enclosed with the SA-5700 Series package is our driver utilities contained in a DVD-ROM disk. Refer to the following table for driver locations:

Filename (Assume that DVD-ROM drive is D :)	Purpose	OS			
		Shell	Win7	Win8.1	Win10
D:\Driver\Flash BIOS	For BIOS update utility	✓	X	X	X
D:\H110\Driver\Platform\Main Chip\Win7(32-bit)	Intel® Chipset Device Software installer	X	✓	X	X
D:\H110\Driver\Platform\Graphic\Win7(32-bit)	Intel(R) HD Graphics installer	X	✓	X	X
D:\H110\Driver\Platform\LAN\Win7(32-bit)	Intel(R) Network Connections Software	X	✓	X	X
D:\H110\Driver\Platform\Sound Codec \Win7(32-bit)	Realtek High Definition Audio System Software	X	✓	X	X
D:\H110\Driver\Platform\USB3.0\Win7(32-bit)	Intel(R) USB 3.0 eXtensible Host Controller	X	✓	X	X
D:\H110\Driver\Platform\KMDF\Win7(32-bit)	Kernel-Mode Driver Framework	X	✓	X	X
D:\H110\Driver\Platform\IME\Win7(32-bit)	Intel(R) Management Engine Components installer	X	✓	X	X
D:\H110\Driver\Platform\Main Chip\Win7(64-bit)	Intel® Chipset Device Software installer	X	✓	X	X
D:\H110\Driver\Platform\Graphic\Win7(64-bit)	Intel(R) HD Graphics installer	X	✓	X	X
D:\H110\Driver\Platform\LAN\Win7(64-bit)	Intel(R) Network Connections Software	X	✓	X	X
D:\H110\Driver\Platform\Sound Codec\Win7(64-bit)	Realtek High Definition Audio System Software	X	✓	X	X
D:\H110\Driver\Platform\USB3.0\Win7(64-bit)	Intel(R) USB 3.0 eXtensible Host Controller	X	✓	X	X
D:\H110\Driver\Platform\KMDF\Win7(64-bit)	Kernel-Mode Driver Framework	X	✓	X	X
D:\H110\Driver\Platform\IME\Win7(64-bit)	Intel(R) Management Engine Components installer	X	✓	X	X

Filename (Assume that DVD-ROM drive is D :)	Purpose	OS			
		Shell	Win7	Win8.1	Win10
D:\H110\Driver\Platform\Main Chip\Win8.1(64-bit)	Intel® Chipset Device Software installer	X	X	✓	X
D:\H110\Driver\Platform\Graphic\Win8.1(64-bit)	Intel(R) HD Graphics installer	X	X	✓	X
D:\H110\Driver\Platform\LAN\Win8.1(64-bit)	Intel(R) Network Connections Software	X	X	✓	X
D:\H110\Driver\Platform\Sound Codec \Win8.1(64-bit)	Realtek High Definition Audio System Software	X	X	✓	X
D:\H110\Driver\Platform\ME\Win8.1(64-bit)	Intel(R) Management Engine Components installer	X	X	✓	X
D:\H110\Driver\Platform\Main Chip \Win10(64-bit)	Intel® Chipset Device Software installer	X	X	X	✓
D:\H110\Driver\Platform\Graphic \Win10(64-bit)	Intel(R) HD Graphics installer	X	X	X	✓
D:\H110\Driver\Platform\LAN\Win10(64-bit)	Intel(R) Network Connections Software	X	X	X	✓
D:\H110\Driver\Platform\Sound Codec \Win10(64-bit)	Realtek High Definition Audio System Software	X	X	X	✓
D:\H110\Driver\Platform\ME\Win10(64-bit)	Intel(R) Management Engine Components installer	X	X	X	✓
D:\H110\Driver\Platform\KMDF\Win7(32-bit)	Kernel-Mode Driver Framework	X	✓	X	X
D:\Q170\Driver\Platform\Main Chip \Win7(32-bit)	Intel® Chipset Device Software installer	X	✓	X	X
D:\Q170\Driver\Platform\Graphic \Win7(32-bit)	Intel(R) HD Graphics installer	X	✓	X	X
D:\Q170\Driver\Platform\LAN\Win7(32-bit)	Intel(R) Network Connections Software	X	✓	X	X
D:\Q170\Driver\Platform\Sound Codec \Win7(32-bit)	Realtek High Definition Audio System Software	X	✓	X	X
D:\Q170\Driver\Platform\KMDF \Win7(32-bit)	Kernel-Mode Driver Framework	X	✓	X	X
D:\Q170\Driver\Platform\USB3.0\Win7(32-bit)	Intel(R) USB 3.0 eXtensible Host Controller	X	✓	X	X
D:\Q170\Driver\Platform\RAID	Intel(R) Rapid Storage	X	✓	X	X

Filename (Assume that DVD-ROM drive is D :)	Purpose	OS			
		Shell	Win7	Win8.1	Win10
Win7(32-bit)	Technology (Intel(R) RST).				
D:\Q170\Driver\Platform\ME\Win7(32-bit)	Intel(R) Management Engine Components installer	X	✓	X	X
D:\Q170\Driver\Platform\Main Chip \Win7(64-bit)	Intel® Chipset Device Software installer	X	✓	X	X
D:\Q170\Driver\Platform\Graphic \Win7(64-bit)	Intel(R) HD Graphics installer	X	✓	X	X
D:\Q170\Driver\Platform\LAN \Win7(64-bit)	Intel(R) Network Connections Software	X	✓	X	X
D:\Q170\Driver\Platform\KMD\Win7(64-bit)	Kernel-Mode Driver Framework	X	✓	X	X
D:\Q170\Driver\Platform\Sound Codec \Win7(64-bit)	Realtek High Definition Audio System Software	X	✓	X	X
D:\Q170\Driver\Platform\USB3.0\Win7(64-bit)	Intel(R) USB 3.0 eXtensible Host Controller	X	✓	X	X
D:\Q170\Driver\Platform\ME\Win7(64-bit)	Intel(R) Management Engine Components installer	X	✓	X	X
D:\Q170\Driver\Platform\RAID\Win7(64-bit)	Intel(R) Rapid Storage Technology (Intel(R) RST).	X	✓	X	X
D:\Q170\Driver\Platform\Main Chip \Win8.1(64-bit)	Intel® Chipset Device Software installer	X	X	✓	X
D:\Q170\Driver\Platform\Graphic \Win8.1(64-bit)	Intel(R) HD Graphics installer	X	X	✓	X
D:\Q170\Driver\Platform\LAN\Win8.1(64-bit)	Intel(R) Network Connections Software	X	X	✓	X
D:\Q170\Driver\Platform\Sound Codec \Win8.1(64-bit)	Realtek High Definition Audio System Software	X	X	✓	X
D:\Q170\Driver\Platform\ME\Win8.1(64-bit)	Intel(R) Management Engine Components installer	X	X	✓	X
D:\Q170\Driver\Platform\RAID\Win8.1(64-bit)	Intel(R) Rapid Storage Technology (Intel(R) RST).	X	X	✓	X
D:\Q170\Driver\Platform\Main Chip \Win10(64-bit)	Intel® Chipset Device Software installer	X	X	X	✓

Filename (Assume that DVD-ROM drive is D :)	Purpose	OS			
		Shell	Win7	Win8.1	Win10
D:\Q170\Driver\Platform\Graphic \Win10(64-bit)	Intel(R) HD Graphics installer	X	X	X	✓
D:\Q170\Driver\Platform\LAN\Win10(64-bit)	Intel(R) Network Connections Software	X	X	X	✓
D:\Q170\Driver\Platform\Sound Codec \Win10(64-bit)	Realtek High Definition Audio System Software	X	X	X	✓
D:\Q170\Driver\Platform\IME\Win10(64-bit)	Intel(R) Management Engine Components installer	X	X	X	✓
D:\Q170\Driver\Platform\RAIDs \Win10(64-bit)	Intel(R) Rapid Storage Technology (Intel(R) RST).	X	X	X	✓

X : Not support

✓ : Support

Note: Install the driver utilities immediately after the OS installation is completed.

4.2 Installing Intel® Chipset Software Installation Utility

4.2.1 Introduction

The Intel® Chipset Software Installation Utility installs the Windows *.INF files to the target system. These files outline to the operating system how to configure the Intel chipset components in order to ensure that the following functions work properly:

- Core PCI and ISAPNP Services
- PCIe Support
- SATA Storage Support
- USB Support
- Identification of Intel® Chipset Components in the Device Manager

4.2.2 Intel® Chipset Software Installation Utility

The utility pack is to be installed only for Windows® 7/8.1/10 series, and it should be installed immediately after the OS installation is finished. Please follow the steps below:

- 1** Connect the USB DVD-ROM device to SA-5700 and insert the driver disk.
- 2** Enter the **Main Chip** folder where the Chipset driver is located.
- 3** Select Windows 7 (32/64-bit) / Windows 8.1 (64-bit) / Windows 10 (64-bit) for your OS platform.
- 4** Click the chipset driver installation file for driver installation.
- 5** Follow the on-screen instructions to install the driver.
- 6** Once the installation is completed, shut down the system and restart SA-5700 for the changes to take effects.

4.3 Intel® Management Engine Components Installer Installation

For Windows 7 only. Pre-install Microsoft's Kernel-Mode Driver Framework (KMDF) version 1.11 before you install the Intel® Management Engine Components Installer (ME) in order to avoid errors in Device Manager.

Installation Instructions for Kernel-Mode Driver Framework (KMDF)

To install the Kernel-Mode Driver Framework (KMDF), follow the steps below:

- 1 Insert the driver disk into a DVD-ROM device.
- 2 (For Windows 7 only) Enter the KMDF folder where the installation driver file is located.
- 3 (For Windows 7 only) Click the Setup kmdf-1.11.exe file for driver installation.

Installation Instructions for Intel® Management Engine Components Installer

- 1 Connect the USB DVD-ROM device to SA-5700 and insert the driver disk.
- 2 Enter the **ME Installation Driver** folder where the driver is located.
- 3 Select Windows 7 (32/64-bit) / Windows 8.1 (64-bit) / Windows 10 (64-bit) for your OS platform.
- 4 Click **SetupME.exe** file for ME driver installation.
- 5 Follow the on-screen instructions to complete the installation.

- 6 Once the installation is completed, shut down the system and restart SA-5700 for the changes to take effect.

4.4 Intel® USB 3.0 eXtensible Host Controller Utility

Intel® USB 3.0 eXtensible Host Controller Driver supports the following Intel® Chipsets/Processors:

- Intel® 8 Series/C220 series Chipset Family
- Intel® 4th Generation Core™ Processors
- Intel® C610 series Chipset Family
- Intel® 9 Series Chipset Family
- Intel® Pentium® Processor or Intel® Celeron® Processor N- & J-Series
- Intel® 5th generation Intel® Core™ Processors
- Intel® Core™ M Processor
- Intel® 6th generation Intel® Core™ processors
- Intel® 100 Series Chipset Family

To install the utility, follow the steps below:

- 1 Insert the driver disk into a DVD-ROM device.
- 2 Under Windows system, go to the directory where the driver is located.
- 3 Run the application with administrative privileges.

4.5 Installing RAID Driver Utility (Only for Q170, Optional)

INTEL® RapidStorage Technology Option ROM

The Intel® Rapid Storage Technology option ROM provides the following:

- Pre-operating system user interface for RAID volume management
- Ability to create, delete and reset RAID volumes
- RAID recovery

User Interface

To enter the Intel® Rapid Storage Technology option ROM user interface, press Ctrl-I when prompted during the Power-On Self-Test (POST).

Option ROM prompt:

```
Intel(R) Rapid Storage Technology - Option ROM - 10.5.0.1034
Copyright(C) 2003-11 Intel Corporation. All Rights Reserved.

RAID Volumes:
None defined.

Physical Devices:
Port Device Model Serial # Size Type/Status(Vol ID)
2 WDC WD1600AAJS-7 WD-WMAP9D045721 149.0GB Non-RAID Disk
3 WDC WD1600AAJS-7 WD-WMAP9D046479 149.0GB Non-RAID Disk
Press <CTRL-I> to enter Configuration Utility...
```

In the user interface, the hard drive(s) and hard drive information listed for your system will differ from the example in the figure below:

Option ROM user interface:

```
Intel(R) Rapid Storage Technology - Option ROM - 10.5.0.1034
Copyright(C) 2003-11 Intel Corporation. All Rights Reserved.
[ MAIN MENU ]
1. Create RAID Volume
2. Delete RAID Volume
3. Reset Disks to Non-RAID
4. Recovery Volume Options
5. Acceleration Options
6. Exit
[ DISK/VOLUME INFORMATION ]
RAID Volumes:
None defined.

Physical Devices:
Port Device Model Serial # Size Type/Status(Vol ID)
0 WDC WD1600AAJS-7 WD-WMAP9D045633 149.0GB Non-RAID Disk
2 WDC WD1600AAJS-7 WD-WMAP9D045721 149.0GB Non-RAID Disk
3 WDC WD1600AAJS-7 WD-WMAP9D046479 149.0GB Non-RAID Disk

[↑↓]-Select [ESC]-Exit [ENTER]-Select Menu
```

Installing RAID Driver Utility (Only for Q170, Optional)

The Intel[®] Rapid Storage Technology (Intel[®] RST) driver supports RAID 0, 1 in Q170 SKU only for 2 x 2.5” SATAIII HDD/SSD. To install the RAID driver utility, follow the steps below:

- 1** Connect the USB DVD-ROM device to SA-5700 and insert the driver disk.
- 2** Enter the **RST** folder where the driver is located.
- 3** Select Windows 7 (32/64-bit) / Windows 8.1 (64-bit) / Windows 10 (64-bit) for your OS platform.
- 4** Click **SetupRST.exe** driver installation file for driver installation.
- 5** Follow the on-screen instructions to complete the installation.
- 6** Once the installation is completed, shut down the system and restart SA-5700 for the changes to take effect.

Note: The RAID driver utility is not supported for H110 SKU.

4.6 Installing Graphics Driver Utility

The graphics interface embedded in SA-5700 can support a wide range of display types. You can have dual displays via DVI-D ports and make the system work simultaneously.

To install the Graphics driver utility, follow the steps below:

- 1** Connect the USB DVD-ROM device to SA-5700 and insert the driver disk.
- 2** Enter the **Graphic** folder where the driver is located.
- 3** Select Windows 7 (32/64-bit) / Windows 8.1 (64-bit) / Windows 10 (64-bit) for your OS platform.
- 4** Click the graphics driver installation file for driver installation.
- 5** Follow the on-screen instructions to complete the installation.
- 6** Once the installation is completed, shut down the system and restart SA-5700 for the changes to take effect.

4.7 Installing LAN Driver Utility

Enhanced with LAN function, SA-5700 supports various network adapters. To install the LAN Driver, follow the steps below:

- 1** Connect the USB DVD-ROM device to SA-5700 and insert the driver disk.
- 2** Enter the **LAN** folder where the driver is located.
- 3** Select Windows 7 (32/64-bit) / Windows 8.1 (64-bit) / Windows 10 (64-bit) for your OS platform.
- 4** Click the LAN driver installation file for driver installation.
- 5** Follow the on-screen instructions to complete the installation.
- 6** Once the installation is completed, shut down the system and restart SA-5700 for the changes to take effects.

For more details on the installation procedure, refer to the README.txt file that you can find on LAN Driver Utility.

4.8 Installing Sound Driver Utility

The sound function enhanced in this system is fully compatible with Windows® 7/8.1/10 series.

To install the Sound Driver, follow the steps below:

- 1** Connect the USB DVD-ROM device to SA-5700 and insert the driver disk.
- 2** Open the **Sound** folder where the driver is located.
- 3** Select Windows 7 (32/64-bit) / Windows 8.1 (64-bit) / Windows 10 (64-bit) for your OS platform.
- 4** Click the Sound driver installation file for driver installation.
- 5** Follow the on-screen instructions to complete the installation.
- 6** Once the installation is completed, shut down the system and restart SA-5700 for the changes to take effect.

5

BIOS SETUP

This chapter guides users how to configure the basic system configurations via the BIOS Setup Utilities. The information of the system configuration is saved in battery-backed CMOS RAM and BIOS NVRAM so that the Setup information is retained when the system is powered off. The BIOS Setup Utilities consist of the following menu items:

- Accessing Setup Utilities
- Main Menu
- Advanced Menu
- Chipset Menu
- Security Menu
- Boot Menu
- Save & Exit Menu

5.1 Introduction

The SA-5700 System uses an AMI (American Megatrends Incorporated) Aptio BIOS that is stored in the Serial Peripheral Interface Flash Memory (SPI Flash) and can be updated. The SPI Flash contains the built-in BIOS setup program, Power-On Self-Test (POST), PCI auto-configuration utility, LAN EEPROM information, and Plug and Play support.

Aptio is AMI's BIOS firmware based on the UEFI (Unified Extensible Firmware Interface) specifications and the Intel Platform Innovation Framework for EFI. The UEFI specification defines an interface between the operating system and platform firmware. The interface consists of data tables that contain platform-related information, boot service calls, and runtime service calls that are available to the operating system and its loader. These elements have combined to provide a standard environment for booting the operating system and running pre-boot applications.

The diagram below shows the Extensible Firmware Interface's location in the software stack.

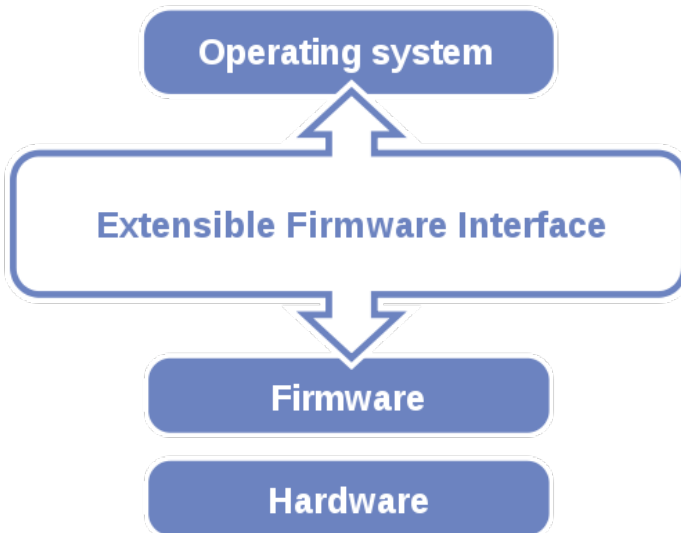

Figure 5-1. Extensible Firmware Interface Diagram

EFI BIOS provides an user interface that allows you to modify hardware configuration, e.g. change the system date and time, enable/disable a system component, determine bootable device priority, set up personal password, etc., which is convenient for engineers to perform modifications and customize the computer system and allows technicians to troubleshoot the occurred errors when the hardware is faulty.

The BIOS setup menu allows users to view and modify the BIOS settings for the computer. After the system is powered on, users can access the BIOS setup menu by pressing or <Esc> immediately while the POST message is running before the operating system is loading.

All the menu settings are described in details in this chapter.

5.2 Accessing Setup Utility

After the system is powered on, BIOS will enter the Power-On Self-Test (POST) routines and the POST message will be displayed:

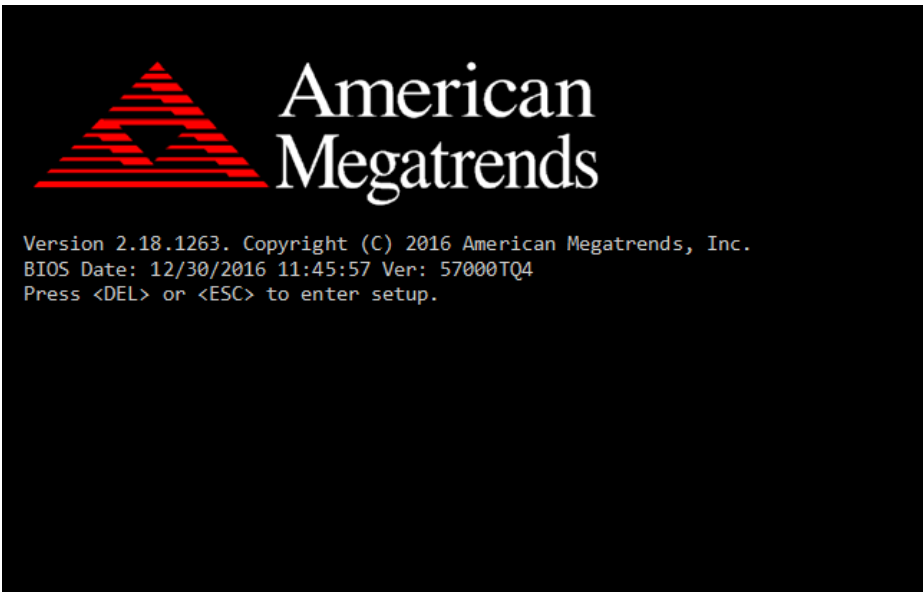
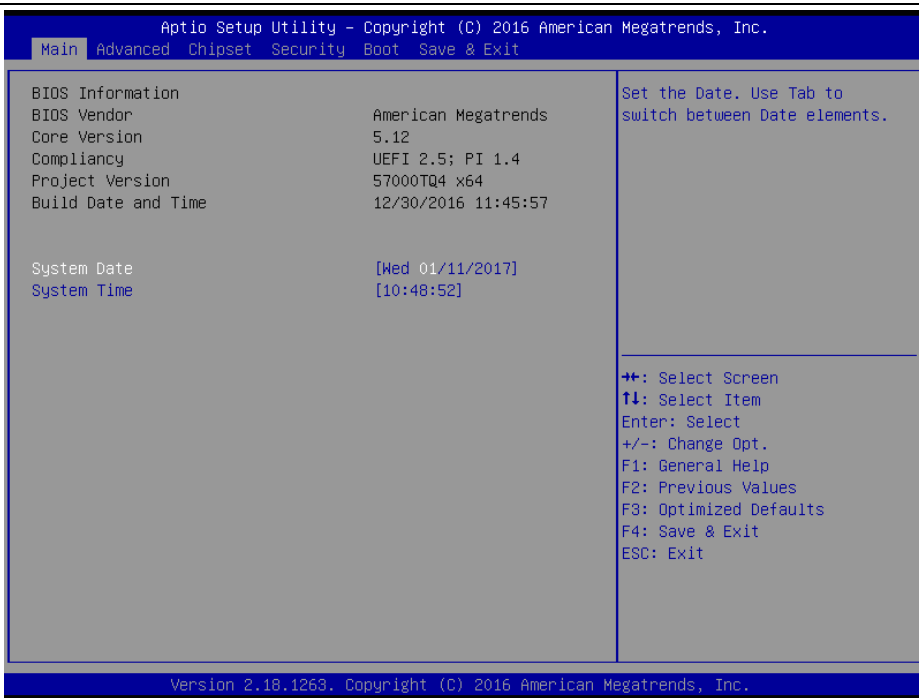

Figure 5-2. POST Screen with AMI Logo

Press or <Esc> to access the Setup Utility program and the **Main** menu of the Aptio Setup Utility will appear on the screen as below:



BIOS Setup Menu Initialization Screen

You may move the cursor by <↑> and <↓> keys to highlight the individual menu items. As you highlight each item, a brief description of the highlighted selection will appear on the right side of the screen.

The language of the BIOS setup menu interface and help messages are shown in US English. You may use <↑> or <↓> key to select among the items and press <Enter> to confirm and enter the sub-menu. The following table provides the list of the navigation keys that you can use while operating the BIOS setup menu.

BIOS Setup Navigation Key	Description
<←> and <→>	Select a different menu screen (move the cursor from the selected menu to the left or right).
<↑> and <↓>	Select a different item (move the cursor from the selected item upwards or downwards)
<Enter>	Execute the command or select the sub-menu.
<F2>	Load the previous configuration values.
<F3>	Load the default configuration values.
<F4>	Save the current values and exit the BIOS setup menu.
<Esc>	Close the sub-menu. Trigger the confirmation to exit BIOS setup menu.

5.3 Main

Menu Path *Main*

The **Main** menu allows you to view the BIOS Information, change the system date and time, and view the user access privilege level. Use tab to switch between date elements. Use <↑> or <↓> arrow keys to highlight the item and enter the value you want in each item. This screen also displays the BIOS version (project) and BIOS Build Date and Time.

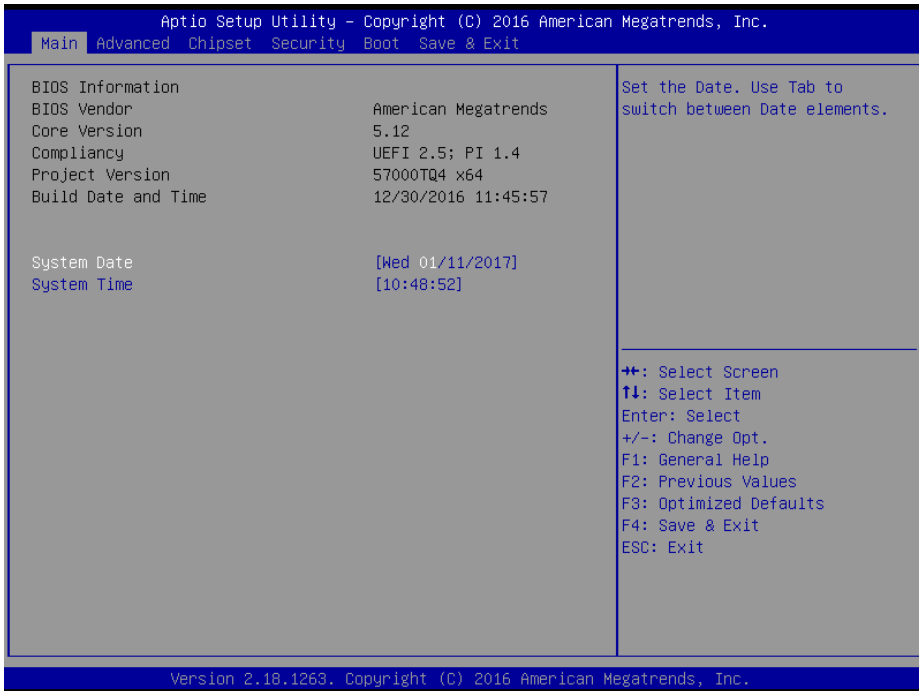

Main Screen

BIOS Setting	Options	Description/Purpose
BIOS Vendor	No changeable options	Displays the BIOS vendor.
Core Version	No changeable options	Displays the current BIOS core version.
Compliancy	No changeable options	Displays the current UEFI version.
Project Version	No changeable options	Displays the version of the BIOS currently installed on the platform.
Build Date and Time	No changeable options	Displays the date of current BIOS version.
System Date	Month, day, year	Sets the system date. The format is [Day Month/ Date/ Year]. Users can directly enter values or use <+> or <-> arrow keys

BIOS Setting	Options	Description/Purpose
		to increase/decrease it. The “Day” is automatically changed.
System Time	Hour, minute, second	Sets the system time. The format is [Hour: Minute: Second]. Users can directly enter values or use <+> or <-> arrow keys to increase/decrease it.

5.4 Advanced

Menu Path *Advanced*

This menu provides advanced configurations such as CPU Configuration, SATA Configuration, PCH-FW Configuration, ACPI Settings, F81866 Super IO Configuration, Hardware Monitor, F81866 Watchdog, Network Stack Configuration and USB Configuration.

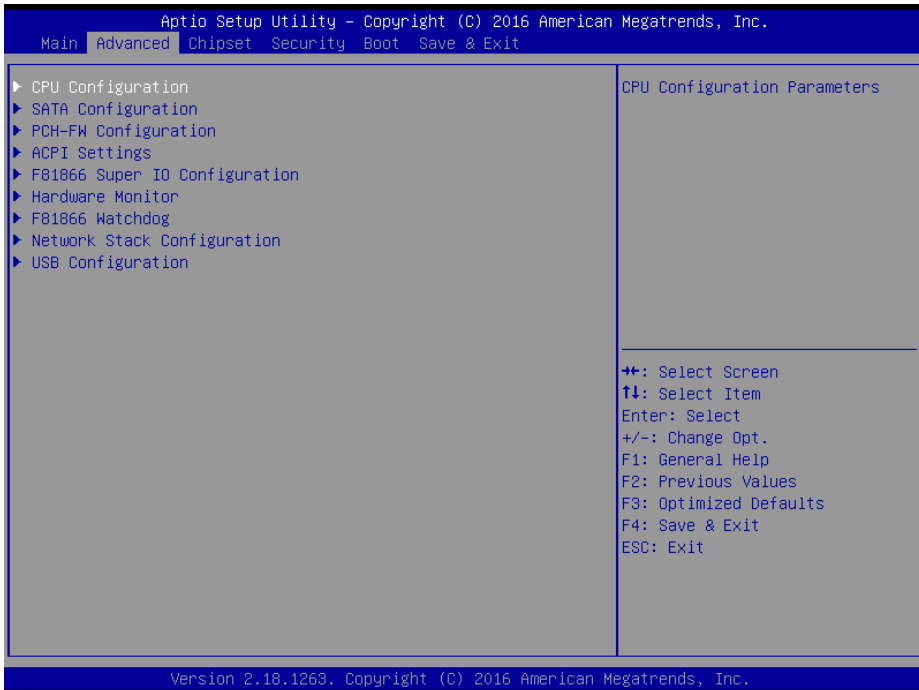

Advanced Menu Screen

BIOS Setting	Options	Description/Purpose
CPU Configuration	Sub-Menu	CPU Configuration Parameters.
SATA Configuration	Sub-Menu	SATA Device Options Settings.
PCH-FW Configuration	Sub-Menu	Management Engine Technology Parameters.
ACPI Settings	Sub-Menu	System ACPI Parameters.
F81866 Super IO Configuration	Sub-Menu	System Super IO Chip Parameters.
Hardware Monitor	Sub-Menu	Monitor hardware status.
F81866 Watchdog	Sub-Menu	F81866 Watchdog Parameters.
Network Stack Configuration	Sub-Menu	Network Stack Settings.
USB Configuration	Sub-Menu	USB Configuration Parameters.

5.4.1 Advanced – CPU Configuration

Menu Path *Advanced > CPU Configuration*

The **CPU Configuration** provides advanced CPU settings and some information about CPU.

Aptio Setup Utility - Copyright (C) 2016 American Megatrends, Inc.

Advanced

CPU Configuration		When enabled, a VMM can utilize the additional hardware capabilities provided by Vanderpool Technology.
Type	Intel(R) Core(TM) i7-7700T CPU @ 2.90GHz	
ID	0x906E9	
Speed	2900 MHz	
L1 Data Cache	32 KB x 4	
L1 Instruction Cache	32 KB x 4	
L2 Cache	256 KB x 4	
L3 Cache	8 MB	
L4 Cache	N/A	
VMX	Supported	
SMX/TXT	Supported	
Intel Virtualization Technology	[Enabled]	↑↓: Select Screen ↑: Select Item Enter: Select +/-: Change Opt. F1: General Help F2: Previous Values F3: Optimized Defaults F4: Save & Exit ESC: Exit
Hyper-Threading	[Enabled]	

Version 2.18.1263. Copyright (C) 2016 American Megatrends, Inc.

CPU Configuration Screen

BIOS Setting	Options	Description/Purpose
CPU Configuration	No changeable options	Displays CPU configuration.
Type	No changeable options	Displays CPU Core.
ID	No changeable options	Displays CPU ID number.
Speed	No changeable options	Displays the CPU speed.
L1 Data Cache	No changeable options	Displays L1 Data Cache size.
L1 Instruction Cache	No changeable options	Displays L1 Instruction Cache size.
L2 Cache	No changeable options	Displays L2 Cache size.
L3 Cache	No changeable options	Displays L3 Cache size.
L4 Cache	No changeable options	Displays L4 Cache size.
VMX	No changeable options	Supports Intel VMX Technology.
SMX/TXT	No changeable options	Reports if Intel Secure Mode Extensions Technology (SMX) /Trusted Execution Technology (TXT) is supported by the processor.

BIOS Setting	Options	Description/Purpose
Intel Virtualization Technology	- Disabled - Enabled	When enabled, VMM can utilize the additional hardware capabilities provided by Vanderpool Technology. Previously codenamed "Vanderpool", VT-x represents Intel's technology for virtualization on the x86 platform.
Hyper-Threading	- Disabled - Enabled	When disabled, only one thread per enabled core is enabled. Hyper Threading is Intel's term for its simultaneous multithreading implementation in their CPUs. Enable this function will improve parallelization of computation performed on PC microprocessor. For each processor core that is physically present, the operating system addresses two virtual processors, and shares the workload between them when possible.

5.4.2 Advanced – SATA Configuration

Menu Path *Advanced > SATA Configuration*

The **SATA Configuration** allows users to enable / disable the SATA controller as well as the operational mode after the SATA controller is enabled. The following screen indicates the functions available when the SATA hard drive is set to work in AHCI mode.

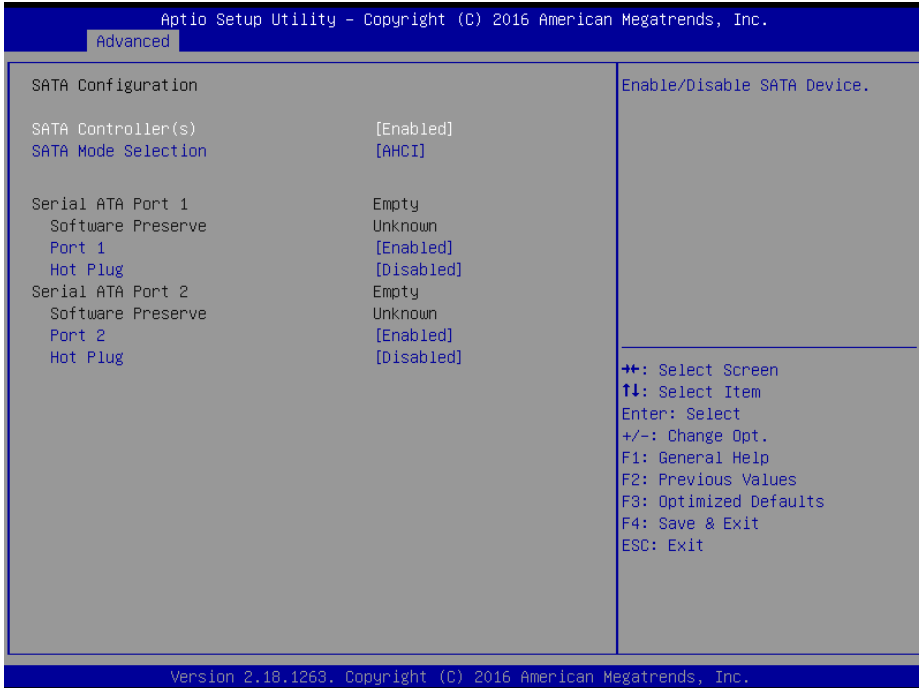

SATA Configuration Screen

BIOS Setting	Options	Description/Purpose
SATA Controller(s)	- Disabled - Enabled	Enables or Disables the on-chip SATA Device. Default: Enabled.
SATA Mode Selection	- AHCI - RAID	Determines how SATA controller(s) operate.
Serial ATA Port 1 – 2,	No changeable options	Display the SATA device's name.
Software Preserve	No changeable options	Indicates whether the connected SATA device supports Software Setting Preservation (SSP).
Port 1 - 2	- Disabled - Enabled	Enables or Disables SATA Port Device.
Hot Plug	- Disabled - Enabled	Enables or Disables SATA Port Device Hot Plug function to designate a SATA port device as hot-pluggable.

5.4.3 Advanced – PCH-FW Configuration

Menu Path Advanced > PCH-FW Configuration

The **PCH-FW** allows users to view the information about ME (Management Engine) firmware information, such as ME firmware version, firmware mode and firmware SKU.

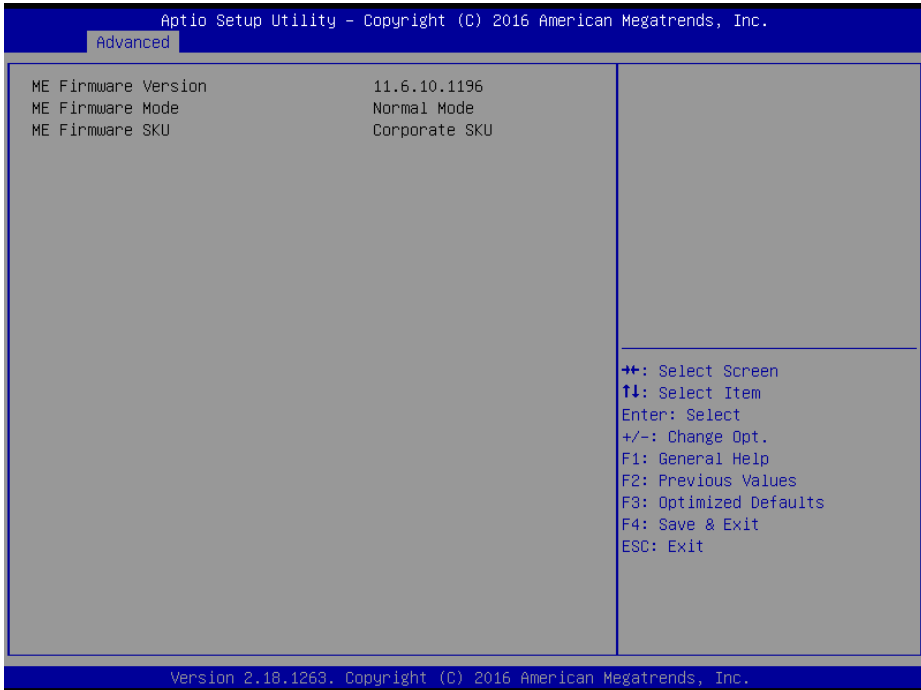

PCH-FW Configuration Screen

BIOS Setting	Options	Description/Purpose
ME Firmware Version	No changeable options	Displays the ME Firmware Version.
ME Firmware Mode	No changeable options	Displays the ME Firmware Mode.
ME Firmware SKU	No changeable options	Displays the ME Firmware SKU.

5.4.4 Advanced – ACPI Settings

Menu Path *Advanced > ACPI Settings*

The **ACPI Settings** allows users to configure relevant ACPI (Advanced Configuration and Power Management Interface) settings such as Enable/Disable Hibernation and ACPI sleep state.

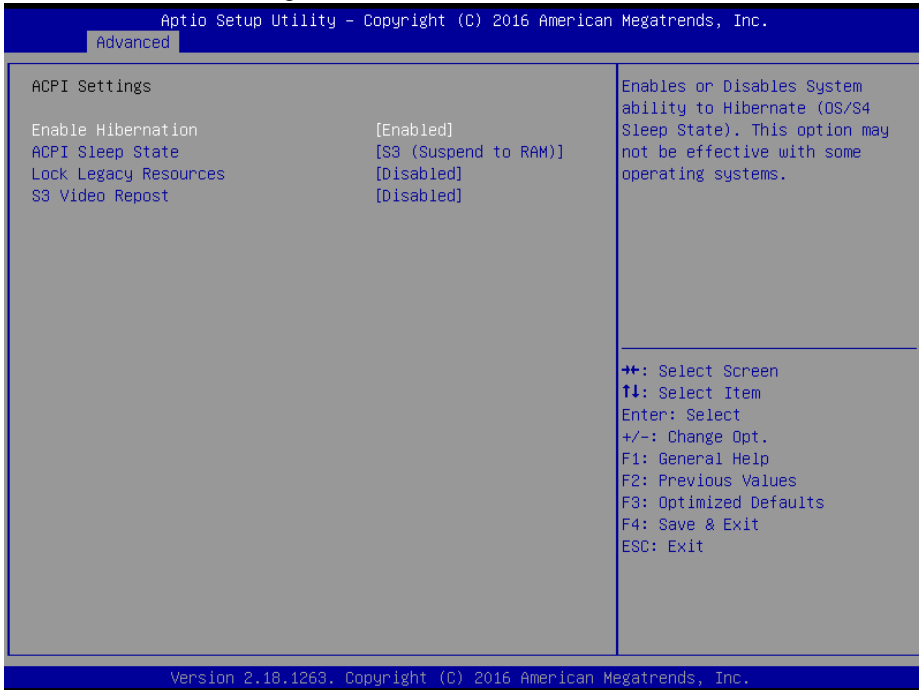

ACPI Settings Screen

BIOS Setting	Options	Description/Purpose
Enable Hibernation	- Disabled - Enabled	Enables or Disables System ability to Hibernate (OS/S4 Sleep State). This option may be not effective with some OS.
ACPI Sleep State	- Suspend Disabled - S3 (Suspend to RAM)	Selects the ACPI sleep state the system will enter when the SUSPEND button is pressed.
Lock Legacy Resources	- Disabled - Enabled	Enables or Disables Lock of Legacy Resources.
S3 Video Repost	- Disabled - Enabled	Enables or Disables S3 Video Repost.

5.4.5 Advanced – F81866 Super IO Configuration

Menu Path *Advanced > F81866 Super IO Configuration*

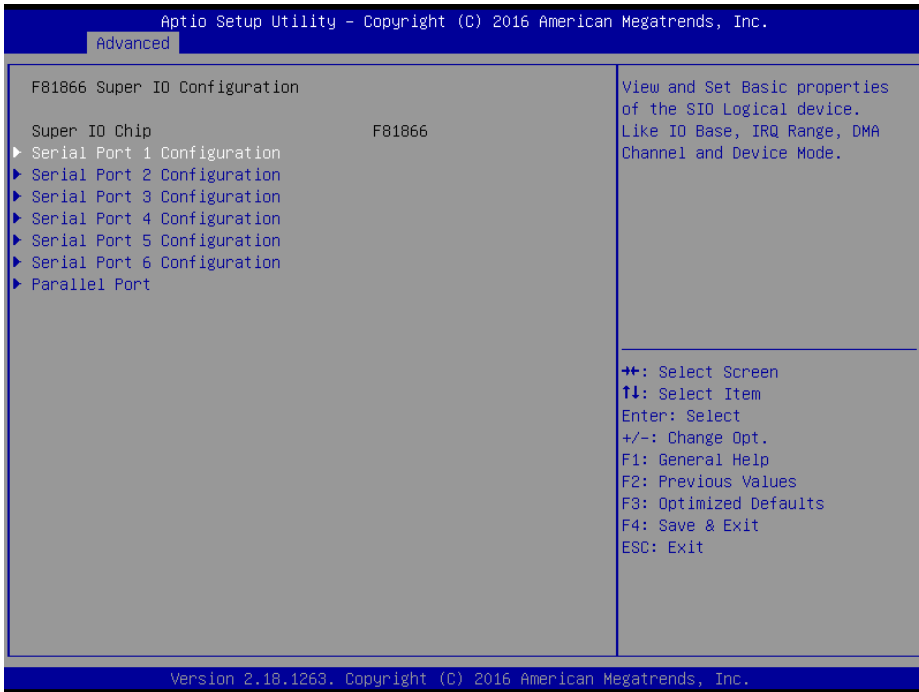

F81866 Super IO Configuration Screen

BIOS Setting	Options	Description/Purpose
Serial Port 1 Configuration	Sub-menu	Sets the parameters of Serial Port 1 (COMA).
Serial Port 2 Configuration	Sub-menu	Sets the parameters of Serial Port 2 (COMB).
Serial Port 3 Configuration	Sub-menu	Sets the parameters of Serial Port 3 (COMC).
Serial Port 4 Configuration	Sub-menu	Sets the parameters of Serial Port 4 (COMD).
Serial Port 5 Configuration	Sub-menu	Sets the parameters of Serial Port 5 (COME).
Serial Port 6 Configuration	Sub-menu	Sets the parameters of Serial Port 6 (COMF).
Parallel Port	Sub-menu	Sets the parameters of Parallel Port (LPT).

Menu Path *Advanced > F81866 Super IO Configuration > Serial Port 1 Configuration*



Serial Port 1 Configuration Screen

BIOS Setting	Options	Description/Purpose
Use This Device	- Disabled - Enabled	Enables or Disables Serial Port 1.
Device Settings	No changeable options	Displays the current settings of Serial Port 1.
Change Settings	- Auto - IO=3F8h; IRQ=4; - IO=3F8h; IRQ=3,4,5,6,7,10,11; - IO=2F8h; IRQ=3,4,5,6,7,10,11; - IO=3E8h; IRQ=3,4,5,6,7,10,11; - IO=2E8h; IRQ=3,4,5,6,7,10,11;	Allows you to select specific IO address and IRQ for Serial Port 1.

Menu Path *Advanced > F81866 Super IO Configuration > Serial Port 2 Configuration*



Serial Port 2 Configuration Screen

BIOS Setting	Options	Description/Purpose
Use This Device	- Disabled - Enabled	Enables or Disables Serial Port 2.
Device Settings	No changeable options	Displays the current settings of Serial Port 2.
Change Settings	- Auto - IO=2F8h; IRQ=3; - IO=3F8h; IRQ=3,4,5,6,7,10,11; - IO=2F8h; IRQ=3,4,5,6,7,10,11; - IO=3E8h; IRQ=3,4,5,6,7,10,11; - IO=2E8h; IRQ=3,4,5,6,7,10,11;	Allows you to select specific IO address and IRQ for Serial Port 2.

Menu Path *Advanced > F81866 Super IO Configuration > Serial Port 3 Configuration*



Serial Port 3 Configuration Screen

BIOS Setting	Options	Description/Purpose
Use This Device	- Disabled - Enabled	Enables or Disables Serial Port 3.
Device Settings	No changeable options	Displays the current settings of Serial Port 3.
Change Settings	- Auto - IO=3E8h; IRQ=7; - IO=3E8h; IRQ=3,4,5,6,7,10,11; - IO=2E8h; IRQ=3,4,5,6,7,10,11; - IO=2F0h; IRQ=3,4,5,6,7,10,11; - IO=2E0h; IRQ=3,4,5,6,7,10,11;	Allows you to select specific IO address and IRQ for Serial Port 3.

Menu Path *Advanced > F81866 Super IO Configuration > Serial Port 4 Configuration*



Serial Port 4 Configuration Screen

BIOS Setting	Options	Description/Purpose
Use This Device	- Disabled - Enabled	Enables or Disables Serial Port 4.
Device Settings	No changeable options	Displays the current settings of Serial Port 4.
Change Settings	- Auto - IO=2E8h; IRQ=10; - IO=3E8h; IRQ=3,4,5,6,7,10,11; - IO=2E8h; IRQ=3,4,5,6,7,10,11; - IO=2F0h; IRQ=3,4,5,6,7,10,11; - IO=2E0h; IRQ=3,4,5,6,7,10,11;	Allows you to select specific IO address and IRQ for Serial Port 4.

Menu Path *Advanced > F81866 Super IO Configuration > Serial Port 5 Configuration*



Serial Port 5 Configuration Screen

BIOS Setting	Options	Description/Purpose
Use This Device	- Disabled - Enabled	Enables or Disables Serial Port 5.
Device Settings	No changeable options	Displays the current settings of Serial Port 5.
Change Settings	- Auto - IO=2F0h; IRQ=6; - IO=3E8h; IRQ=3,4,5,6,7,10,11; - IO=2E8h; IRQ=3,4,5,6,7,10,11; - IO=2F0h; IRQ=3,4,5,6,7,10,11; - IO=2E0h; IRQ=3,4,5,6,7,10,11;	Allows you to select specific IO address and IRQ for Serial Port 5.

Menu Path *Advanced > F81866 Super IO Configuration >
Serial Port 6 Configuration*

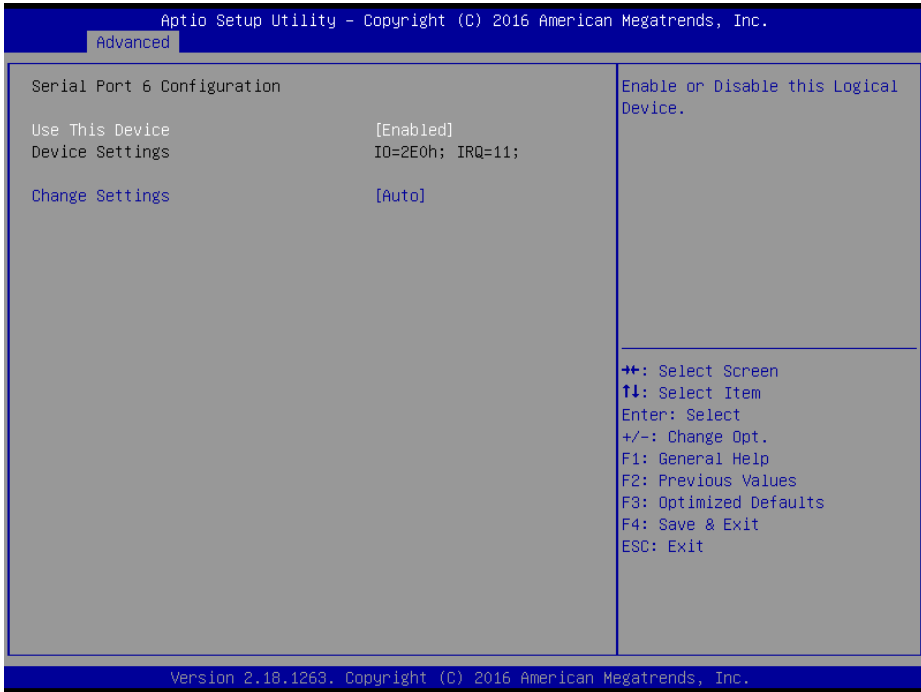

Serial Port 6 Configuration Screen

BIOS Setting	Options	Description/Purpose
Use This Device	- Disabled - Enabled	Enables or Disables Serial Port 6.
Device Settings	No changeable options	Displays the current settings of Serial Port 6.
Change Settings	- Auto - IO=2E0h; IRQ=11; - IO=3E8h; IRQ=3,4,5,6,7,10,11; - IO=2E8h; IRQ=3,4,5,6,7,10,11; - IO=2F0h; IRQ=3,4,5,6,7,10,11; - IO=2E0h; IRQ=3,4,5,6,7,10,11;	Allows you to select specific IO address and IRQ for Serial Port 6.

Menu Path *Advanced > F81866 Super IO Configuration > Parallel Port Configuration*

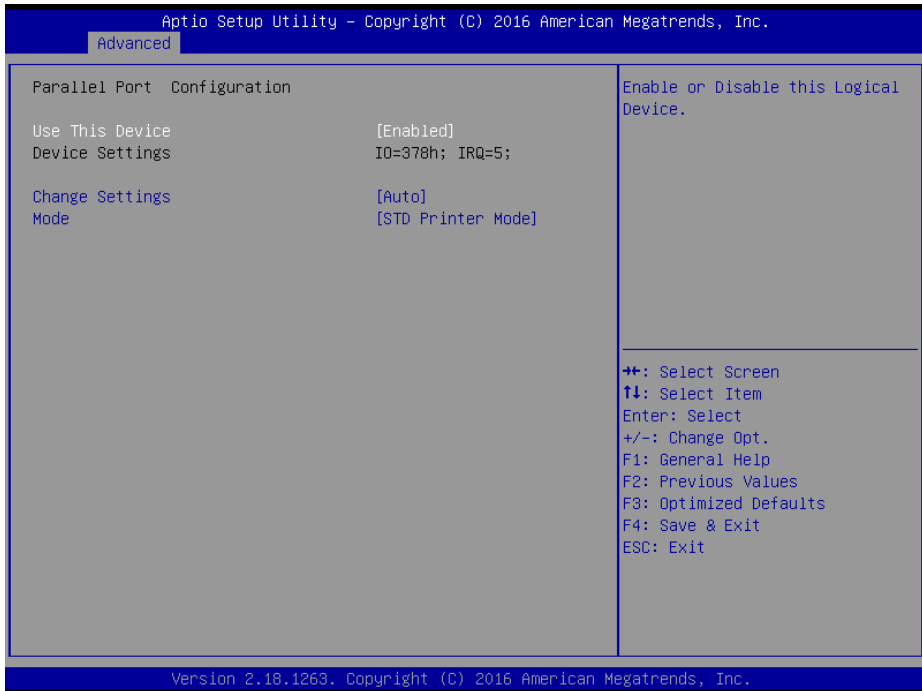

Parallel Port Configuration Screen

BIOS Setting	Options	Description/Purpose
Use This Device	- Disabled - Enabled	Enables or Disables parallel port.
Device Settings	No changeable options	Displays the current settings of Parallel Port.
Change Settings	- Auto - IO=378h; IRQ=5; - IO=378h; IRQ=5,6,7,9,10,11,12; - IO=278h; IRQ=5,6,7,9,10,11,12; - IO=3BCh; IRQ=5,6,7,9,10,11,12;	Allows you to select specific IO address and IRQ for Parallel Port.
Mode	- STD Printer Mode - SPP Mode - EPP-1.9 and SPP Mode - EPP-1.7 and SPP Mode - ECP Mode - ECP and EPP 1.9 Mode - ECP and EPP 1.7 Mode	Allows you to hange Parallel Port mode. Some of the Mode required a DMA resource. After Mode is changed, reset the system to reflect actual device settings.

5.4.6 Advanced – Hardware Monitor

Menu Path *Advanced > Hardware Monitor*

The **Hardware Monitor** allows users to monitor the health and status of the system such as CPU temperature, system temperature and voltage levels in supply.

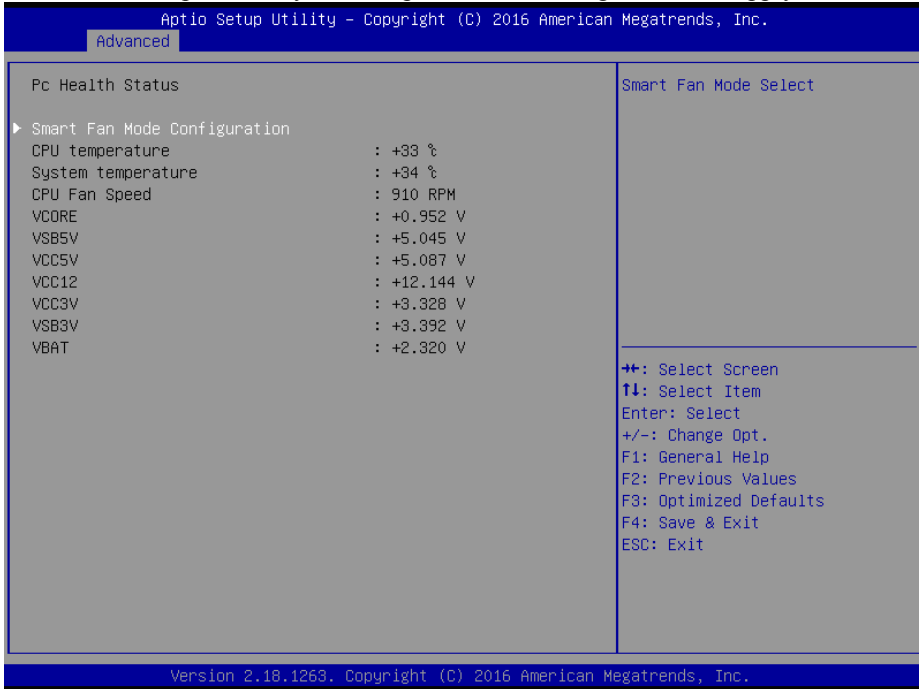

Hardware Monitor Screen

BIOS Setting	Options	Description/Purpose
Smart Fan Mode Configuration	Sub-Menu	Smart Fan Mode Selection
CPU Temperature	No changeable options	Displays the processor's temperature.
System Temperature	No changeable options	Displays the system's temperature.
CPU Fan Speed	No changeable options	Displays CPU Fan speed
VCORE	No changeable options	Detects and displays the VCORE CPU voltage.
VSB5V	No changeable options	Detects and displays voltage level of the VSB5V in supply.
VCC5V	No changeable options	Detects and displays voltage level of the VCC5V in supply.
VCC12	No changeable options	Detects and displays voltage level of the VCC12 in supply.
VCC3V	No changeable options	Detects and displays voltage level of the VCC3V in supply.

BIOS Setting	Options	Description/Purpose
VSB3V	No changeable options	Detects and displays voltage level of the VSB3V in supply.
VBAT	No changeable options	Detects and displays the battery voltage.

5.4.6.1 Advanced – Hardware Monitor – Smart Fan Mode Configuration

Menu Path *Advanced > Hardware Monitor > Smart Fan Mode Configuration*

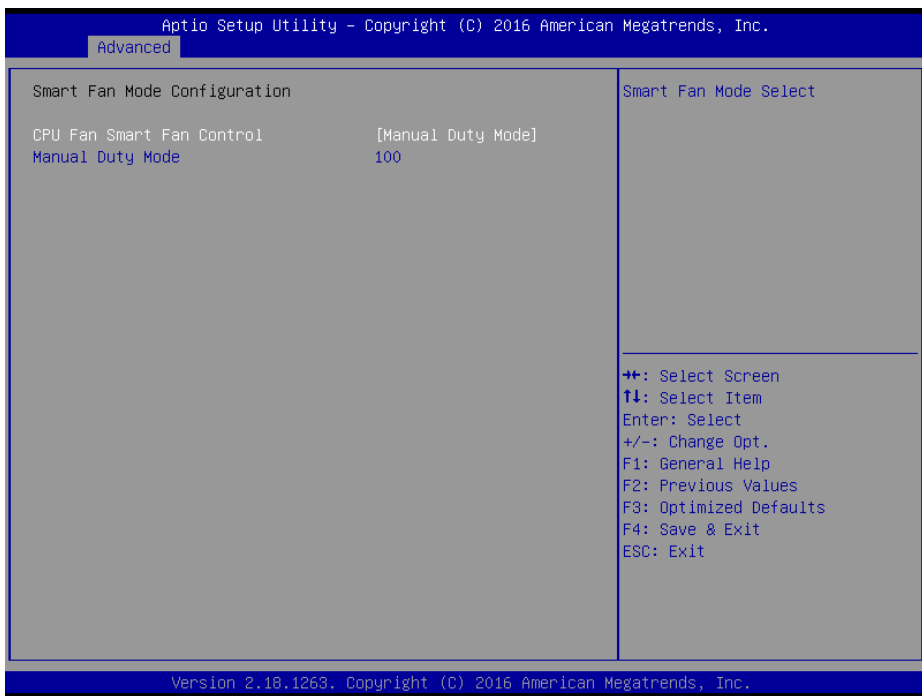

Smart Fan Mode Configuration Screen

BIOS Setting	Options	Description/Purpose
CPU Fan Smart Fan Control	- Manual Duty Mode - Auto Duty-Cycle Mode	Smart Fan Mode selection for CPU Fan.
Manual Duty Mode	Numeric (from 1 to 100)	Manual mode fan control. Users can write expected duty cycle from 1-100 (PWM fan type).

5.4.7 Advanced – F81866 Watchdog Configuration

Menu Path *Advanced > F81866 Watchdog*

If the system hangs or fails to respond, enable the F81866 Watchdog function to trigger a system reset via the 255-level watchdog timer.



F81866 Watchdog Configuration Screen

BIOS Setting	Options	Description/Purpose
Enable Watchdog	- Enabled - Disabled	Enables/Disables F81866 Watchdog timer settings.
Watchdog timer unit	- 1s - 60s	Selects 1s (second) or 60s (minute) as the time unit of Watchdog timer.
Count for Timer (Seconds)	Numeric (from 1 to 255)	Sets the timeout for Watchdog timer. (Max. value: 255 seconds or minutes)

5.4.8 Advanced – Network Stack Configuration

Menu Path *Advanced > Network Stack Configuration*

The **Network Stack Configuration** allows users to enable/disable UEFI Network Stack, IPv4/IPv6 PXE (Pre-Boot eXecution Environment) support and configure PXE boot wait time and detects the media presence.

PXE allows a workstation to boot from a server on a network prior to booting the operating system on the local hard drive. A PXE-enabled workstation connects its NIC to the LAN via a jumper, which keeps the workstation connected to the network even when the power is turned off.

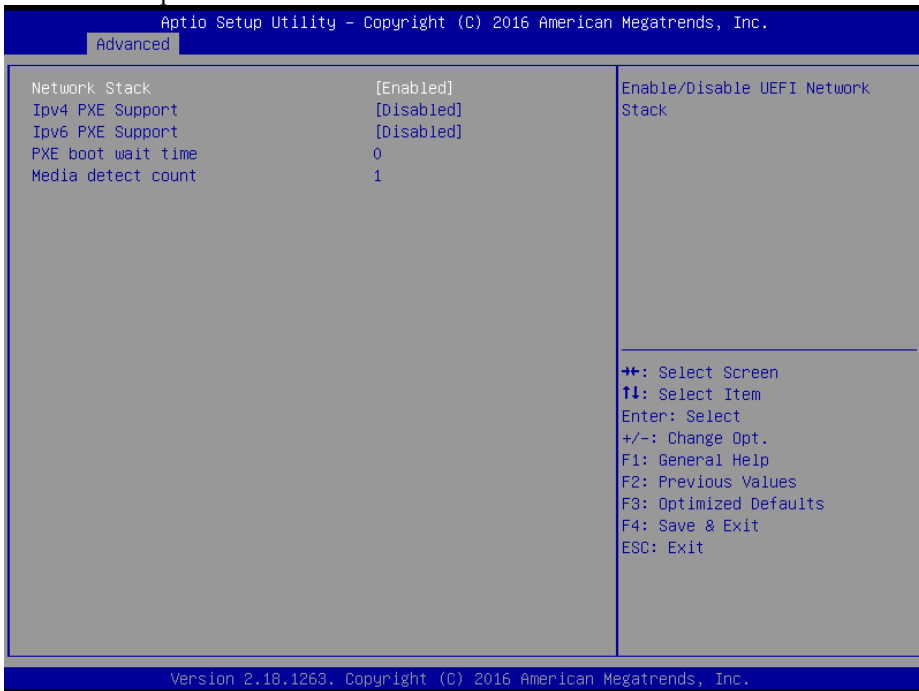

Network Stack Configuration Screen

BIOS Setting	Options	Description/Purpose
Network Stack	- Disabled - Enabled	Enables or Disables UEFI Network Stack.
Ipv4 PXE Support	- Disabled - Enabled	Enables IPv4 PXE Boot Support. If disabled, IPv4 PXE boot option will not be created.
Ipv6 PXE Support	- Disabled - Enabled	Enables IPv6 PXE Boot Support. If disabled, IPv6 PXE boot option will not be created.
PXE boot wait	Numeric (from 0 to 5)	Number of seconds to wait for PXE boot

BIOS Setting	Options	Description/Purpose
time		to abort after the Esc key is pressed.
Media detect count	Numeric (from 1 to 50)	Number of times that the media presence will be checked.

5.4.9 Advanced – USB Configuration

Menu Path *Advanced > USB Configuration*

The **USB Configuration** allows users to enable/disable USB mass storage driver support.

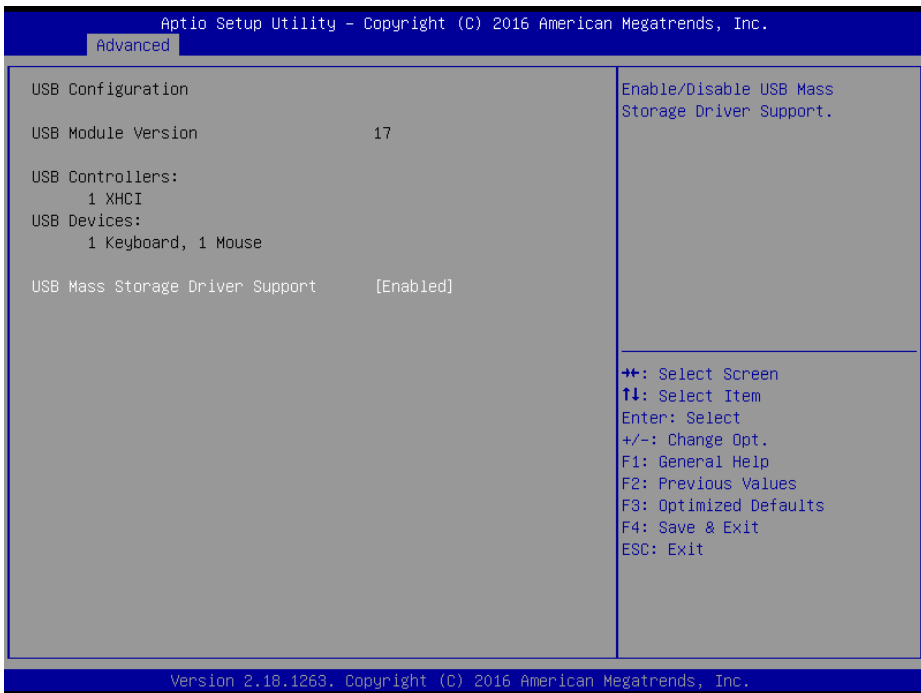

USB Configuration Screen

BIOS Setting	Options	Description/Purpose
USB Mass Storage Driver Support	- Enabled - Disabled	Enables or Disables USB mass storage driver support.

5.5 Chipset

Menu Path *Chipset*

This menu allows users to configure advanced Chipset settings such as System Agent (SA) and PCH-IO configuration parameters.

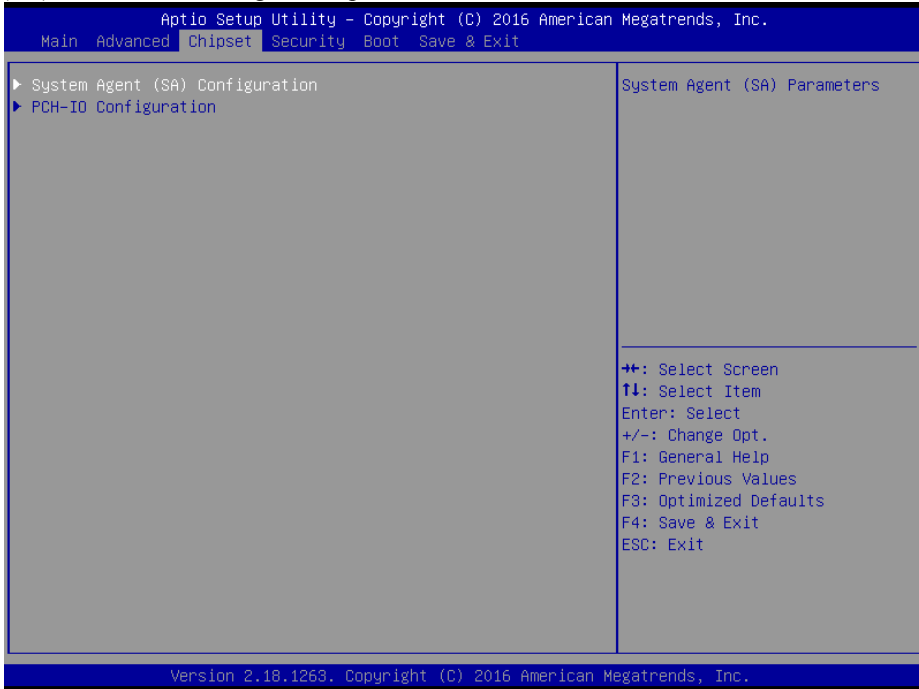

Chipset Screen

BIOS Setting	Options	Description/Purpose
System Agent (SA) Configuration	Sub-menu	System Agent (SA) parameters.
PCH-IO Configuration	Sub-menu	PCH parameters.

5.5.1 Chipset – System Agent (SA) Configuration

Menu Path *Chipset > System Agent (SA) Configuration*

The **System Agent Configuration** allows users to display DRAM information on the platform as well as configure graphics settings.



System Agent (SA) Configuration Screen

BIOS Setting	Options	Description/Purpose
SA PCIe Code Version	No changeable options	Displays the SA PCIe Code Version.
VT-d	No changeable options	Indicates whether Intel's VT-d (Virtualization Technology for Directed I/O) capability is supported. <i>VT-d</i> extends Intel's Virtualization Technology (VT) roadmap by providing hardware assists for virtualization solution, and helps end users improve security and reliability of the systems and also improves performance of I/O devices in virtualized environment.
Memory Configuration	Sub-menu	Displays the DRAM information on the platform.
Graphics Configuration	Sub-menu	Configures Graphics Settings.

BIOS Setting	Options	Description/Purpose
PEG Port Configuration	Sub-menu	PEG (PCI Express Graphics) Port Configuration.
VT-d	- Disabled - Enabled	Enables or Disables VT-d function.

5.5.1.1 Chipset – SA Configuration – Memory Configuration

Menu Path *Chipset > System Agent (SA) Configuration > Memory Configuration*

The **Memory Configuration** allows users to check for the information about the memory frequency, total DRAM size and memory (RAM) timings, etc.

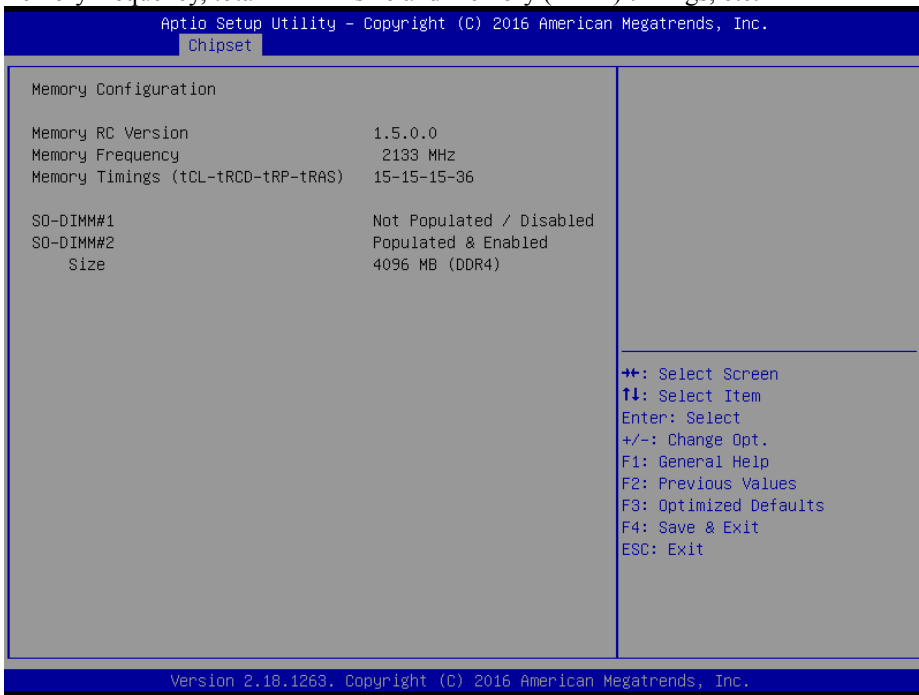

Memory Configuration Screen

BIOS Setting	Options	Description/Purpose
Memory RC Version	No changeable options	Displays the Memory RC Version.
Memory Frequency	No changeable options	Displays the Frequency of Memory.
Memory Timings (tCL-tRCD-tRP-tRAS)	No changeable options	Displays the Memory (RAM) timings and latency. <ul style="list-style-type: none"> • CAS Latency (tCL) - This is the most important memory timing. CAS stands

BIOS Setting	Options	Description/Purpose
		<p>for Column Address Strobe. If a row has already been selected, it tells us how many clock cycles we'll have to wait for a result (after sending a column address to the RAM controller).</p> <ul style="list-style-type: none"> • Row Address (RAS) to Column Address (CAS) Delay (tRCD) - Once we send the memory controller a row address, we'll have to wait this many cycles before accessing one of the row's columns. So, if a row hasn't been selected, this means we'll have to wait tRCD + tCL cycles to get our result from the RAM. • Row Precharge Time (tRP) - If we already have a row selected, we'll have to wait this number of cycles before selecting a different row. This means it will take tRP + tRCD + tCL cycles to access the data in a different row. • Row Active Time (tRAS) - This is the minimum number of cycles that a row has to be active for to ensure we'll have enough time to access the information that's in it. This usually needs to be greater than or equal to the sum of the previous three latencies (tRAS = tCL + tRCD + tRP).
SO-DIMM#1	No changeable options	Displays if SO-DIMM#1 socket is populated/enabled or not.
SO-DIMM#2	No changeable options	Displays if SO-DIMM#2 socket is populated/enabled or not.
Size	No changeable options	Displays the total memory size.

5.5.1.2 Chipset – System Agent (SA) Configuration – Graphics Configuration

Menu Path *Chipset > System Agent (SA) Configuration > Graphics Configuration*

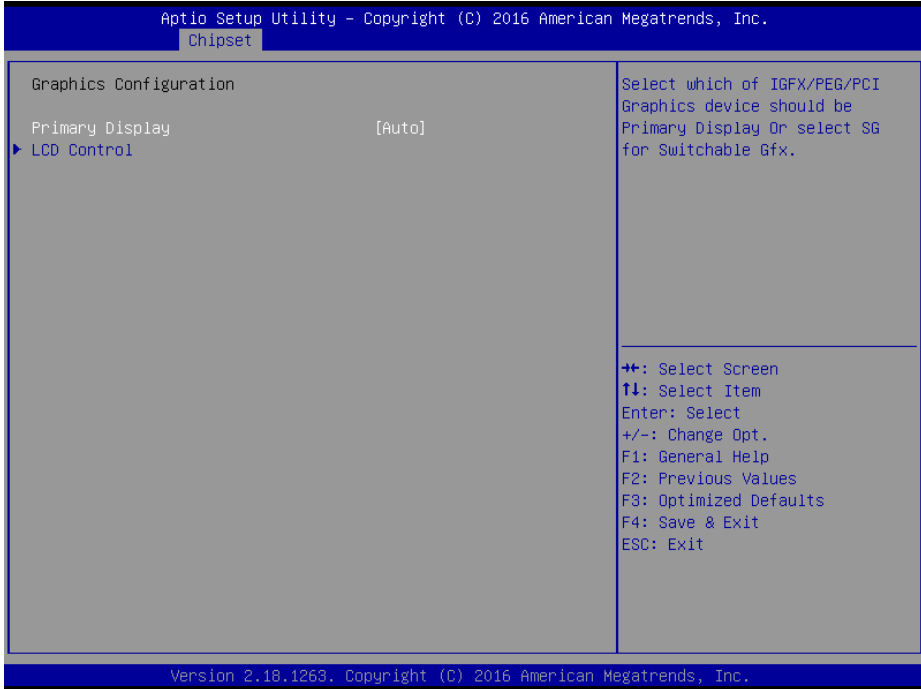

Graphics Configuration Screen

BIOS Setting	Options	Description/Purpose
Primary Display	- Auto - IGFX - PEG	Select which of IGFX/PEG Graphics device should be Primary Display.
LCD Control	Sub-menu	LCD Control sub-menu.

Menu Path *Chipset > System Agent (SA) Configuration > Graphics Configuration > LCD Control*

The **LCD Control** allows users to select the primary and secondary display device.

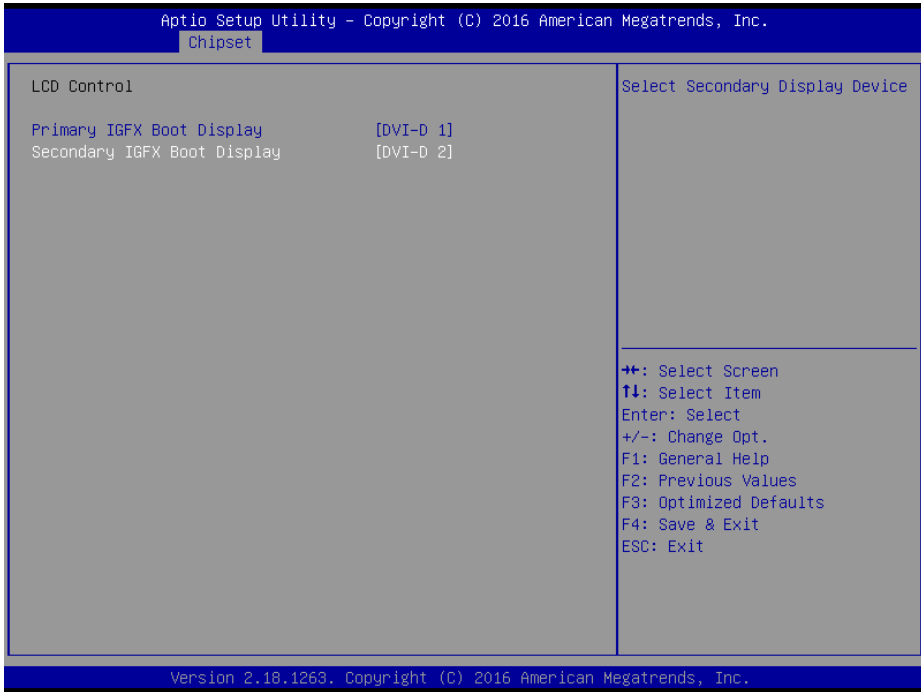

LCD Control Screen

BIOS Setting	Options	Description/Purpose
Primary IGFX Boot Display	<ul style="list-style-type: none"> - VBIOS default - DVI-D 1 - DVI-D 2 - DisplayPort 	Selects Primary Display Device.
Secondary IGFX Boot Display	<ul style="list-style-type: none"> - Disabled - DVI-D 1 - DVI-D 2 - DisplayPort 	Selects Secondary Display Device.

5.5.1.3 Chipset –System Agent (SA) Configuration – PEG Port Configuration

Menu Path *Chipset > System Agent (SA) Configuration > PEG Port Configuration*

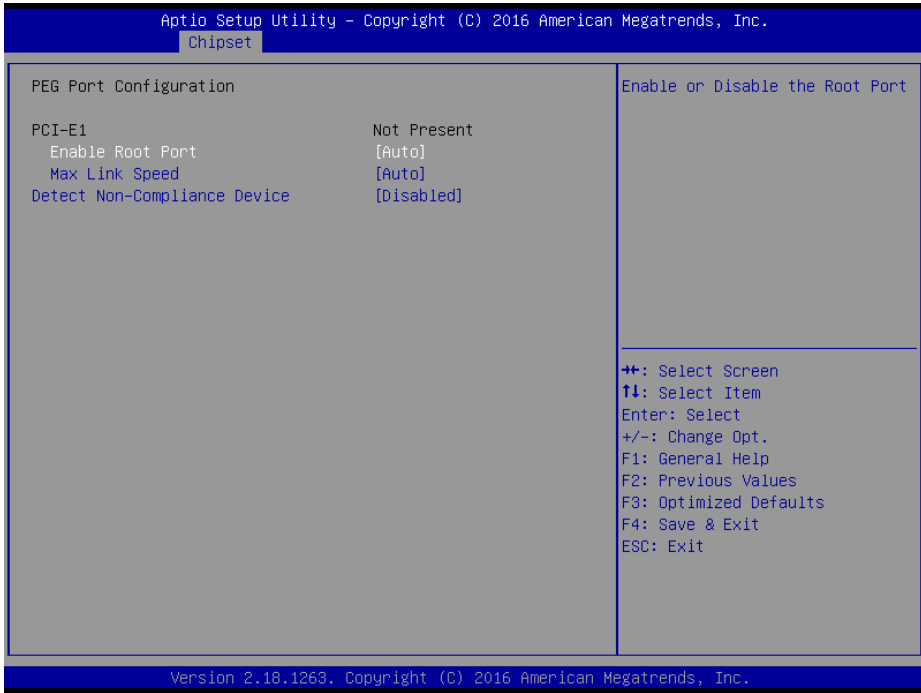

PEG Port Configuration Screen

BIOS Setting	Options	Description/Purpose
PCI-E1	No changeable options	Displays PCI-E1 Link and speed information.
Enable Root Port	- Disabled - Enabled - Auto	Enables or Disables the Root Port.
Max Link Speed	- Auto - Gen1 - Gen2 - Gen3	Configures PCI-E1 maximum speed.
Detect Non-Compliance Device	- Disabled - Enabled	Detects Non-Compliance PCI Express Device in PEG.

5.5.2 Chipset – PCH-IO Configuration

Menu Path *Chipset > PCH-IO Configuration*

The **PCH-IO** Configuration allows users to set PCI Express configuration parameters, enable/disable PCH LAN Controller and Wake-On-LAN function and determine the power on/off state that the system will go into following a power failure (G3 state).

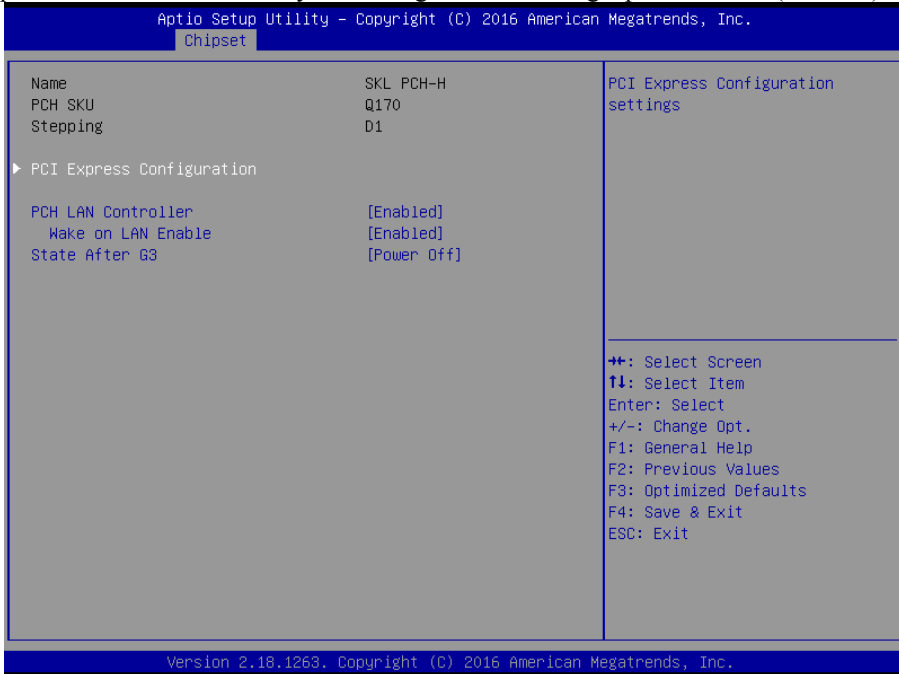

PCH-IO Configuration Screen

BIOS Setting	Options	Description/Purpose
Name	No changeable options	Displays the Intel PCH Name.
PCH SKU	No changeable options	Displays the Intel PCH SKU.
Stepping	No changeable options	Displays the Intel PCH Stepping.
PCI Express Configuration	Sub-menu	Configures PCI Express Configuration settings.
PCH LAN Controller	- Disabled - Enabled	Enables or Disables onboard NIC.
Wake on LAN Enable	- Disabled - Enabled	Enables or Disables integrated LAN to wake up the system. Default: Enabled.
State After G3	- Power On - Power Off	Specifies the Power On/Off state that the system will go into when the power is re-applied following a power failure (G3 state).

5.5.2.1 Chipset – PCH-IO Configuration – PCI Express Configuration

Menu Path *Chipset > PCH-IO Configuration > PCI Express Configuration*

The **PCI Express Configuration** allows users to configure Mini PCI Express Port settings.

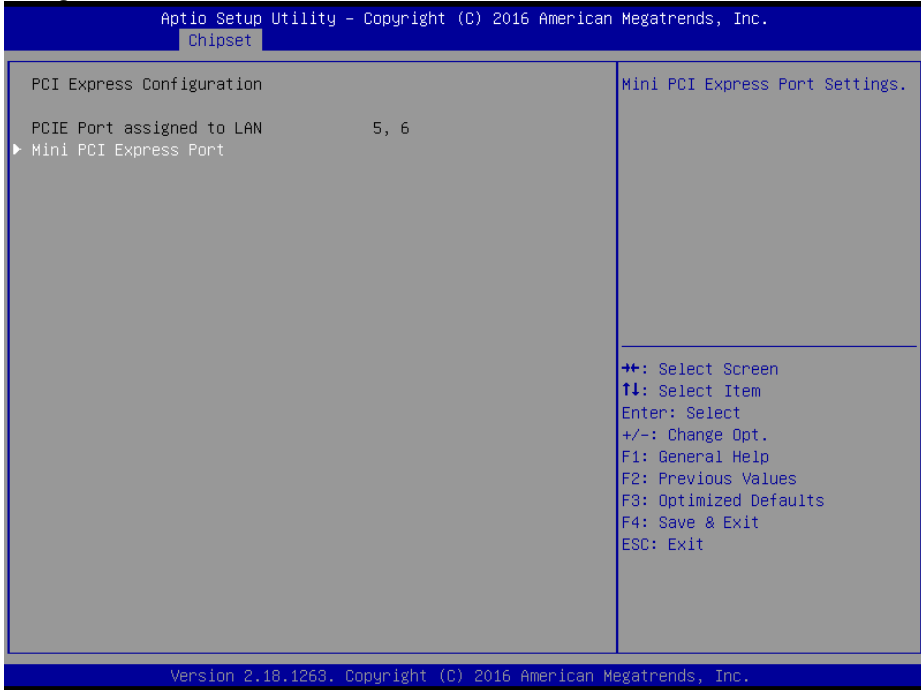

PCI Express Configuration Screen

BIOS Setting	Options	Description/Purpose
PCI Express Port assigned to LAN	No changeable options	Displays the LAN assigned PCI Express Port.
Mini PCI Express Port	Sub-menu	Configures Mini PCI Express Port settings.

Menu Path *Chipset > PCH-IO Configuration > PCI Express Configuration > Mini PCI Express Port Configuration*

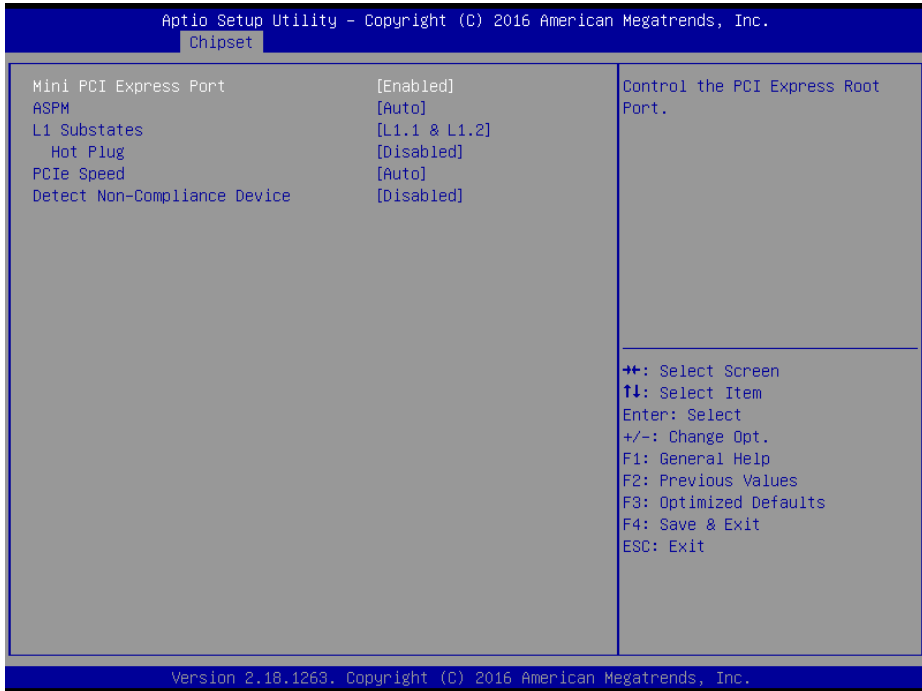

Mini PCI Express Port Configuration Screen

BIOS Setting	Options	Description/Purpose
Mini PCI Express Port	- Disabled - Enabled	Controls the PCI Express Root Port.
ASPM	- Disabled - L0s - L1 - L0sL1 - Auto	Sets the PCI Express ASPM (Active-State Power Management) Level. The option allows users to set the lower power mode that activates when the bus is not being used.
L1 Substates	- Disabled - L1.1 - L1.2 - L1.1 & L1.2	PCI Express L1 Substates settings.
Hot Plug	- Disabled - Enabled	Enables or Disables PCI Express Hot Plug.
PCIe Speed	- Auto - Gen1 - Gen2 - Gen3	Selects PCI Express Port Speed.

BIOS Setting	Options	Description/Purpose
Detect Non-Compliance Device	- Disabled - Enabled	Detects Non-Compliance PCI Express Device. If enabled, it will take more time during POST.

5.6 Security

Menu Path *Security*

From the **Security** menu, you are allowed to create, change or clear the administrator password. You will be asked to enter the configured administrator password before you can access the Setup Utility.

By setting an administrator password, you will prevent other users from changing your BIOS settings. You can configure an Administrator password and then configure a user password. An administrator has much more privileges over the settings in the Setup utility than a user. Heed that a user password does not provide access to most of the features in the Setup utility.

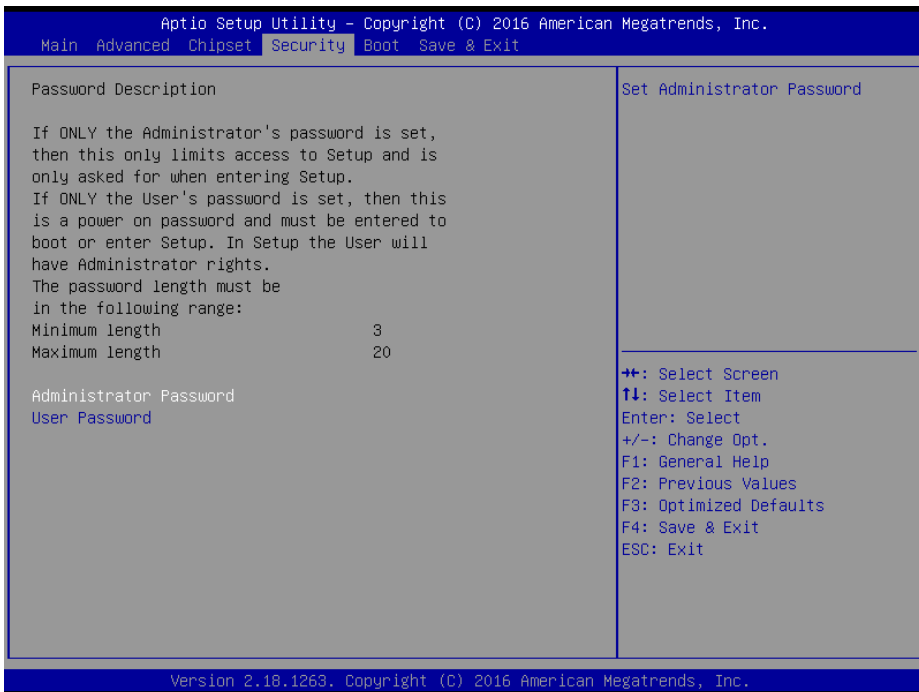

Security Screen

BIOS Setting	Options	Description/Purpose
Administrator Password	Password can be 3-20 alphanumeric characters.	Specifies the administrator password.
User Password	Password can be 3-20 alphanumeric characters.	Specifies the user password.

Create an Administrator or User Password

1. Select the **Administrator Password / User Password** option from the Security menu and press <Enter>, and the password dialog entry box appears.
2. Enter the password you want to create. A password can be 3-20 alphanumeric characters. After you have configured the password, press <Enter> to confirm.
3. Type the new password again and press <Enter>.

Change an Administrator or User Password

1. Select the **Administrator Password / User Password** option from the Security menu and press <Enter>, and the password dialog entry box appears.
2. Select the Administrator Password or User Password that you want to change. A password can be 3-20 alphanumeric characters. After you have changed the password, press <Enter> to confirm.
3. Type the changed password again and press <Enter>.

Remove an Administrator or User Password

1. Select the **Administrator Password / User Password** option from the Security menu and press <Enter>, and the password dialog entry box appears.
2. Select the configured Administrator Password or User Password that you want to delete. Leave the dialog box blank and press <Enter>.
3. Press <Enter> again when the password confirmation box appears.

5.7 Boot

Menu Path Boot

This menu provides control items for system boot configuration such as setting setup prompt timeout, enabling/disabling quiet boot and fast boot, changing the boot order from the available bootable device(s), and setting CSM (Compatibility Support Module) configuration parameters to support legacy BIOS operation systems, various bootable devices and add-on devices for achieving better compatibility.

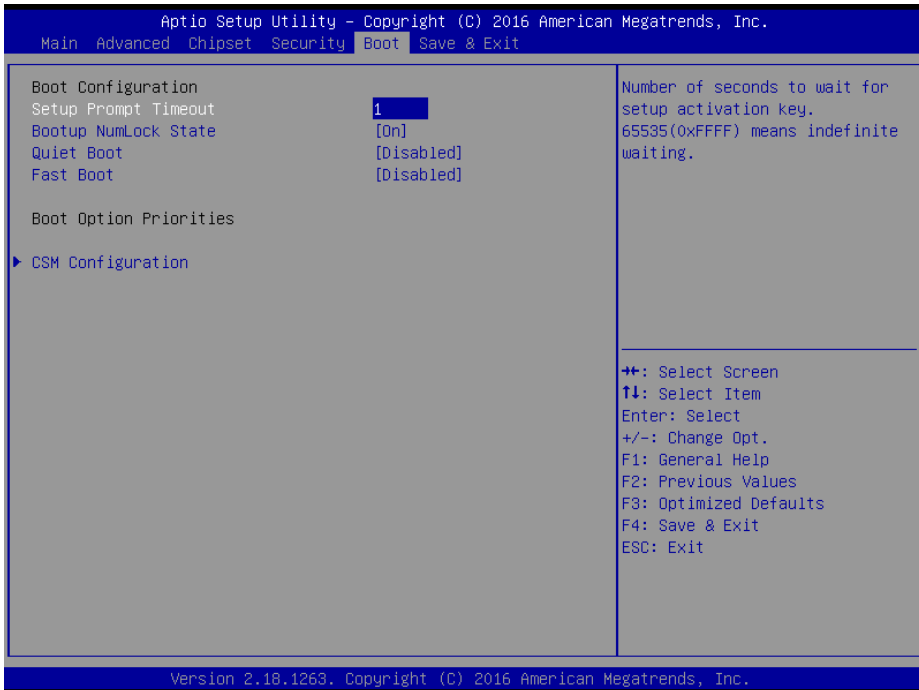

Boot Screen

BIOS Setting	Options	Description/Purpose
Setup Prompt Timeout	Numeric (from 1 to 65535)	Number of seconds to wait for setup activation key.
Bootup NumLock State	- On - Off	Selects the NumLock state after the system is powered on. <ul style="list-style-type: none"> • On: Enables the NumLock function automatically after the system is powered on. • Off: Disables the NumLock function after the system is powered on.

BIOS Setting	Options	Description/Purpose
Quiet Boot	- Disabled - Enabled	Enables or Disables Quiet Boot options. When this option is set to “Disabled”, BIOS will display normal POST messages.
Fast Boot	- Disabled - Enabled	Enables or Disables Fast Boot options.
Boot Option #1~#n	- [Drive(s)] - Disabled	Allows users to change the boot order from the available device(s). Note that in the menu displayed, you will only see the device with the highest priority for a specific boot device type.
CSM Configuration	Sub-Menu	CSM configuration: Enable/Disable, Option ROM execution settings, etc.

5.7.1 Boot – CSM Configuration

Menu Path *Boot > CSM Configuration*

The **CSM Configuration** provides advanced CSM (Compatibility Support Module) configurations such as Enable/Disable CSM Support, configure Option ROM execution, boot option filter, etc.

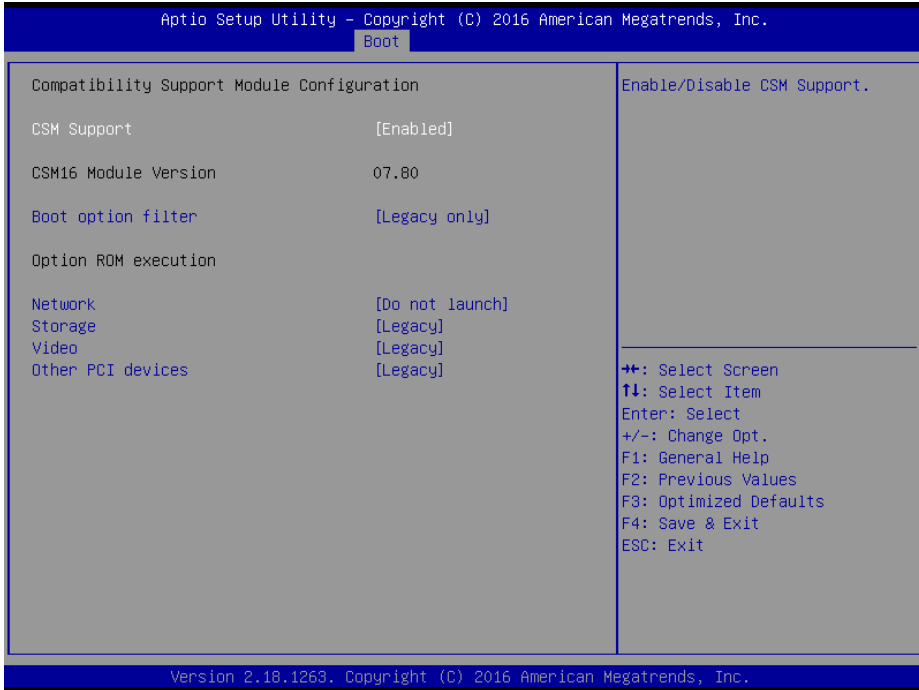

CSM Configuration Screen

BIOS Setting	Options	Description/Purpose
CSM Support	- Disabled - Enabled	Enables or Disables CSM Support.
CSM16 Module Version	No changeable options	Displays the CSM 16 Module version.
Boot option filter	- UEFI and Legacy - Legacy only - UEFI only	This option controls Legacy/UEFI ROMs priority.
Network	- Do not launch - UEFI - Legacy	Controls the execution of UEFI and Legacy PXE OpROM.

BIOS Setting	Options	Description/Purpose
Storage	<ul style="list-style-type: none">- Do not launch- UEFI- Legacy	Controls the execution of UEFI and Legacy Storage OpROM.
Video	<ul style="list-style-type: none">- Do not launch- UEFI- Legacy	Controls the execution of UEFI and Legacy Video OpROM.
Other PCI devices	<ul style="list-style-type: none">- Do not launch- UEFI- Legacy	Determines OpROM execution policy for devices other than Network, Storage or Video.

5.8 Save & Exit

Menu Path *Save & Exit*

The **Save & Exit** allows users to save or discard changed BIOS settings as well as load factory default settings.

Save Changed BIOS Settings

To save and validate the changed BIOS settings, select **Save Changes** from the **Save & Exit** menu, or you can select **Save Changes and Exit** (or press **F4**) to validate the changes and then exit the system. Select **Save Changes and Reset** to validate the changed BIOS settings and then restart the system

Discard Changed BIOS Settings

To cancel the BIOS settings you have previously configured, select **Discard Changes and Exit** from this menu, or simply press **Esc** to exit the BIOS setup. You can also select **Discard Changes and Reset** to discard any changes you have made and restore the factory BIOS defaults.

Load User Defaults

You may simply press **F3** at any time to load the **Optimized Values** which resets all BIOS settings to the factory defaults.

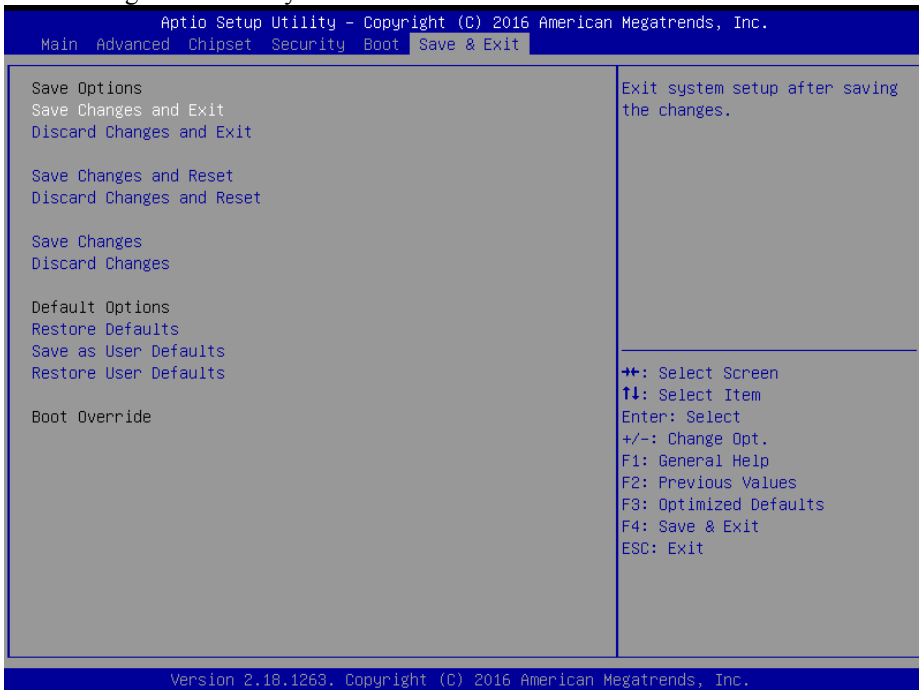

Save & Exit Screen

BIOS Setting	Options	Description/Purpose
Save Changes and Exit	No changeable options	Exits the system and saves the changes in NVRAM.
Discard Changes and Exit	No changeable options	Exits the system without saving any changes configured in BIOS settings.
Save Changes and Reset	No changeable options	Saves the changes in NVRAM and resets the system.
Discard Changes and Reset	No changeable options	Resets the system without saving any changes configured in BIOS settings.
Save Changes	No changeable options	Saves the changes done so far to any of the setup options.
Discard Changes	No changeable options	Discards the changes done so far to any of the setup options.
Restore Defaults	No changeable options	Loads the optimized defaults for BIOS settings.
Save as User Defaults	No changeable options	Saves the changes done so far as User Defaults.
Restore User Defaults	No changeable options	Restores the User Defaults to all the BIOS settings.
Boot Override	- [Drive(s)]	Forces to boot from selected [drive(s)].

Appendix A System Diagrams

This appendix includes the exploded diagrams of the system and the parts list as well as the part numbers of the SA-5700 system.

- SA-5700 System Exploded Diagram
- SA-5700 CPU Heat Sink Exploded Diagram
- SA-5700 SATA HDD Exploded Diagram

SA-5700 System Exploded Diagram

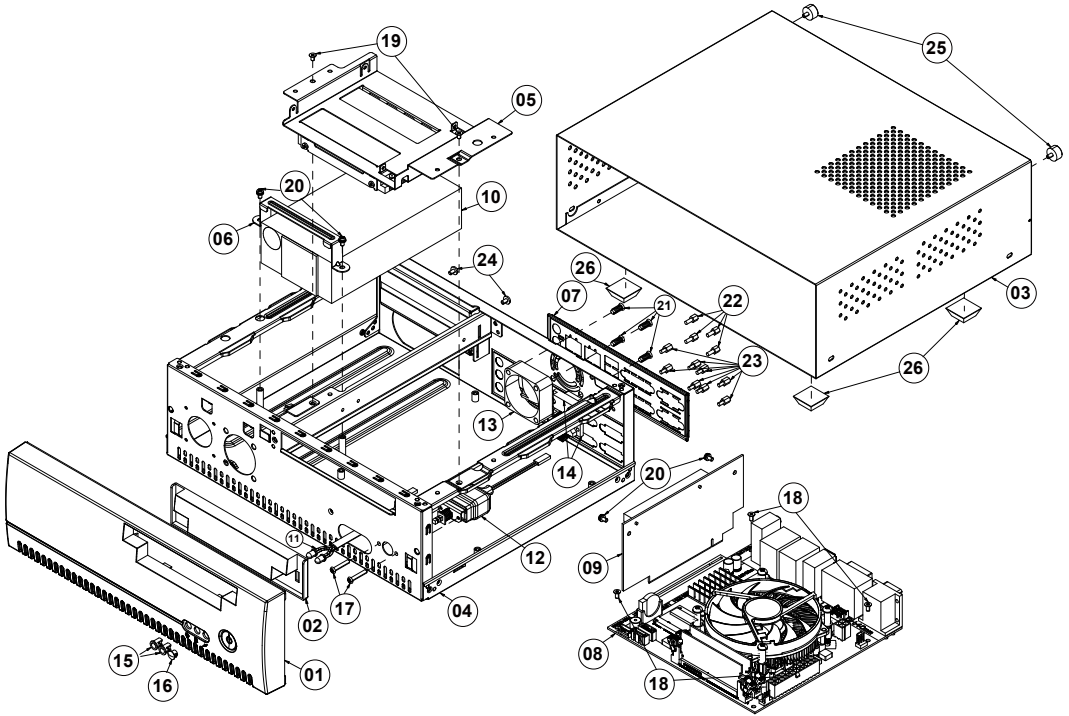

Appendix A System Diagrams

No.	Component Name	Part No.	Q'ty
1	ST-1808 FRONT PANEL STD TYPE C (Black)	30-003-28210006	1
2	PS-8080-FRONT PANEL CD-ROM FDD LID (Black)	30-003-08410006	1
3	SA-5076 TOP CHASSIS (w/Paint) (Black)	20-015-03061233	1
4	SA-5942 INNER CHASSIS ASSY	20-015-03001313	1
5	DRIVE BAY KIT EXP	SEE PAGE A-5	1
6	PMB-531LF POWER SUPPLY HOLDER	20-029-03001082	1
7	SA-5700 IO SHIELD+MYLAR	80-010-07001388	1
8	SB-5700 PCB ASSY EXP	SEE PAGE A-4	1
9	PCI-Express x16 Riser Card	52-152-16296000	1
10	ATX 270W POWER SUPPLY	-	1
11	PMB-531LF POWER & HDD LED CABLE L=190mm (GREEN & RED)	27-018-08204071	1
12	SA-0897 POWER SWITCH CABLE L=200mm	27-019-25104071	1
13	ST-1942 SYSTEM FAN x 2 (40x40x15mm) L=200mm + 150mm	21-004-04040382	1
14	ST-1082 / SA-5082 COM PORT CABLE (9M to 10F) L=95mm	27-024-23702031	2
15	LED HOUSING (Black)	30-014-04100009	2
16	HOLE PLUG (Φ6.3 ~6.5mm) (Black)	30-054-04100000	1
17	PAN HEAD SCREW M3x0.5Px18mm	22-222-30018011	2
18	FLAT HEAD SCREW M3x0.5Px6mm (Black)	22-215-30060011	4
19	FLAT HEAD SCREW #2 / φ5 / M3x0.5Px5mm	22-212-30005311	2
20	ROUND HEAD WITH SPRING WASHER SCREW M3x0.5Px6mm	22-232-30060211	4
21	FLAT HEAD SCREW #2 / T4.7x11mm	82-712-47011018	4
22	HEX CU BOSS UNC No. 4-40, L=4.8, H=7mm	22-692-40048051	4
23	HEX CU BOSS UNC No. 4-40, L=5, H=6mm	22-392-40005301	8
24	PAN HEAD SCREW UNC-No. 6-32, L=5mm	22-622-60005011	2
25	HANDEL HEAD SCREW UNC-No. 6-32, L=5mm	22-382-06005031	2
26	BPC-8060/8070/8080/8580 RUBBER FOOT (20.5x20.5x7.6mm) (Black)	90-004-01100038	4

SA-5700 CPU Heat Sink Exploded Diagram

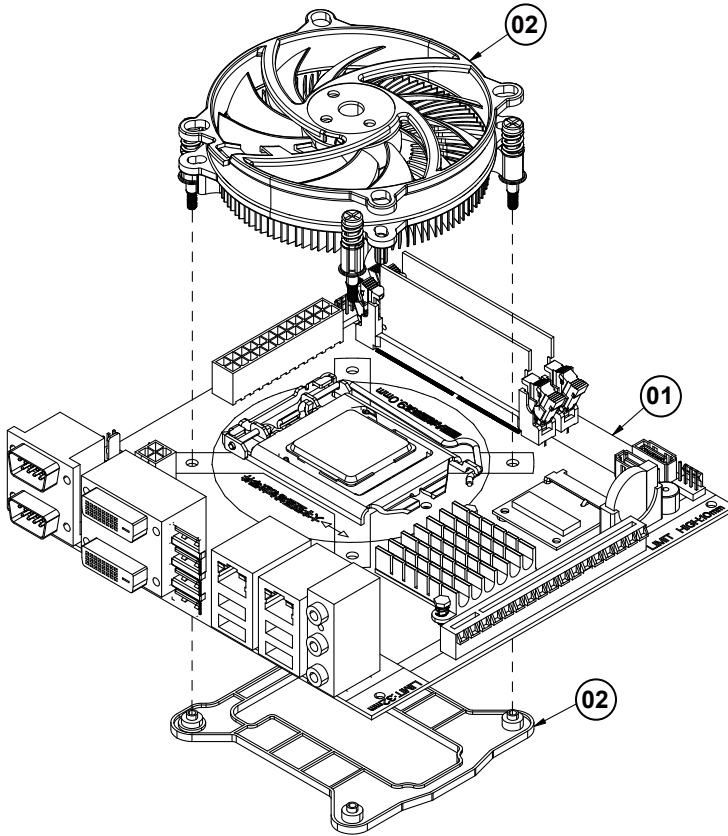

No.	Component Name	Part No.	Q'ty
1	SB-5700 MAINBOARD	-	1
2	SP-7625 CPU HEAT SINK(ϕ 96x16.8) & FAN(95x95x13mm) L=300mm	21-003-09595002	1

SA-5700 SATA HDD Exploded Diagram

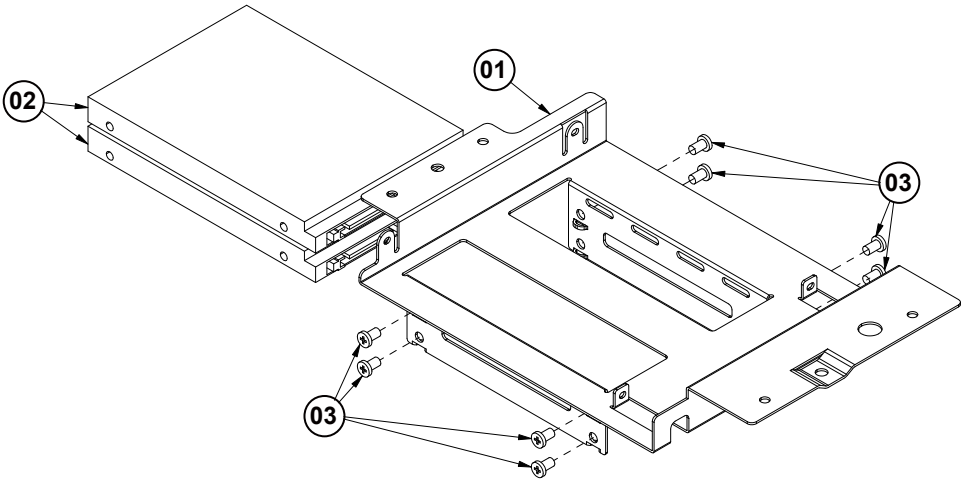

No.	Component Name	Part No.	Q'ty
1	PMB-531LF DRIVE BAY FOR 2.5" HDD	20-004-03001082	1
2	2.5" HDD SATA	-	2
3	FILLISTER HEAD SCREW #2 / M3x0.5Px5mm	22-272-30049015	8

Appendix B Technical Summary

This appendix will give you a brief introduction of the allocation maps for the system resources.

The following topics are included:

- System Block Diagram
- Interrupt Map
- I/O Map
- DMA Channels Map
- Memory Map
- Configuring WatchDog Timer
- Flash BIOS Update

System Block Diagram

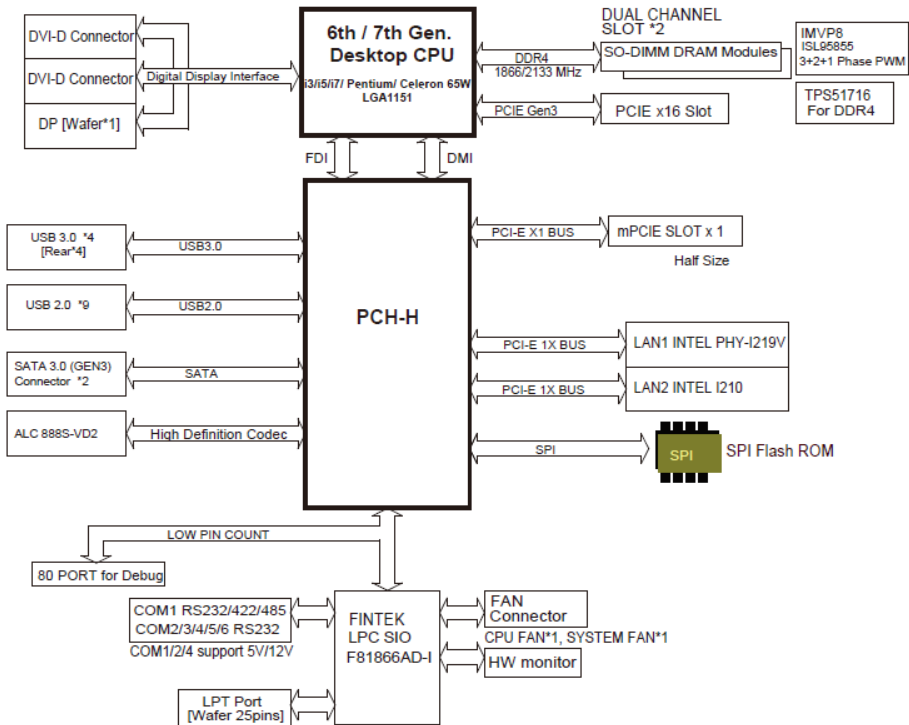

Interrupt Map

IRQ	Assignment
IRQ 0	System timer
IRQ 4	Communications Port (COM1)
IRQ 3	Communications Port (COM2)
IRQ 7	Communications Port (COM3)
IRQ 10	Communications Port (COM4)
IRQ 6	Communications Port (COM5)
IRQ 11	Communications Port (COM6)
IRQ 8	System CMOS/real time clock
IRQ 11	Intel(R) 100 Series/C230 Series Chipset Family SMBus - A123
IRQ 11	Intel(R) 100 Series/C230 Series Chipset Family Thermal subsystem - A131
IRQ 13	Numeric data processor
IRQ 14	Motherboard resources
IRQ 16	High Definition Audio Controller
IRQ 54	Microsoft ACPI-Compliant System
IRQ 55	Microsoft ACPI-Compliant System
IRQ 56	Microsoft ACPI-Compliant System
IRQ 57	Microsoft ACPI-Compliant System
IRQ 58	Microsoft ACPI-Compliant System
IRQ 59	Microsoft ACPI-Compliant System
IRQ 60	Microsoft ACPI-Compliant System
IRQ 61	Microsoft ACPI-Compliant System
IRQ 62	Microsoft ACPI-Compliant System
IRQ 63	Microsoft ACPI-Compliant System
IRQ 64	Microsoft ACPI-Compliant System

IRQ	Assignment
IRQ 65	Microsoft ACPI-Compliant System
IRQ 66	Microsoft ACPI-Compliant System
IRQ 67	Microsoft ACPI-Compliant System
IRQ 68	Microsoft ACPI-Compliant System
IRQ 69	Microsoft ACPI-Compliant System
IRQ 70	Microsoft ACPI-Compliant System
IRQ 71	Microsoft ACPI-Compliant System
IRQ 72	Microsoft ACPI-Compliant System
IRQ 73	Microsoft ACPI-Compliant System
IRQ 74	Microsoft ACPI-Compliant System
IRQ 75	Microsoft ACPI-Compliant System
IRQ 76	Microsoft ACPI-Compliant System
IRQ 77	Microsoft ACPI-Compliant System
IRQ 78	Microsoft ACPI-Compliant System
IRQ 79	Microsoft ACPI-Compliant System
IRQ 80	Microsoft ACPI-Compliant System
IRQ 81	Microsoft ACPI-Compliant System
IRQ 82	Microsoft ACPI-Compliant System
IRQ 83	Microsoft ACPI-Compliant System
IRQ 84	Microsoft ACPI-Compliant System
IRQ 85	Microsoft ACPI-Compliant System
IRQ 86	Microsoft ACPI-Compliant System
IRQ 87	Microsoft ACPI-Compliant System
IRQ 88	Microsoft ACPI-Compliant System
IRQ 89	Microsoft ACPI-Compliant System
IRQ 90	Microsoft ACPI-Compliant System
IRQ 91	Microsoft ACPI-Compliant System

IRQ	Assignment
IRQ 92	Microsoft ACPI-Compliant System
IRQ 93	Microsoft ACPI-Compliant System
IRQ 94	Microsoft ACPI-Compliant System
IRQ 95	Microsoft ACPI-Compliant System
IRQ 96	Microsoft ACPI-Compliant System
IRQ 97	Microsoft ACPI-Compliant System
IRQ 98	Microsoft ACPI-Compliant System
IRQ 99	Microsoft ACPI-Compliant System
IRQ 100	Microsoft ACPI-Compliant System
IRQ 101	Microsoft ACPI-Compliant System
IRQ 102	Microsoft ACPI-Compliant System
IRQ 103	Microsoft ACPI-Compliant System
IRQ 104	Microsoft ACPI-Compliant System
IRQ 105	Microsoft ACPI-Compliant System
IRQ 106	Microsoft ACPI-Compliant System
IRQ 107	Microsoft ACPI-Compliant System
IRQ 108	Microsoft ACPI-Compliant System
IRQ 109	Microsoft ACPI-Compliant System
IRQ 110	Microsoft ACPI-Compliant System
IRQ 111	Microsoft ACPI-Compliant System
IRQ 112	Microsoft ACPI-Compliant System
IRQ 113	Microsoft ACPI-Compliant System
IRQ 114	Microsoft ACPI-Compliant System
IRQ 115	Microsoft ACPI-Compliant System
IRQ 116	Microsoft ACPI-Compliant System
IRQ 117	Microsoft ACPI-Compliant System
IRQ 118	Microsoft ACPI-Compliant System

IRQ	Assignment
IRQ 119	Microsoft ACPI-Compliant System
IRQ 120	Microsoft ACPI-Compliant System
IRQ 121	Microsoft ACPI-Compliant System
IRQ 122	Microsoft ACPI-Compliant System
IRQ 123	Microsoft ACPI-Compliant System
IRQ 124	Microsoft ACPI-Compliant System
IRQ 125	Microsoft ACPI-Compliant System
IRQ 126	Microsoft ACPI-Compliant System
IRQ 127	Microsoft ACPI-Compliant System
IRQ 128	Microsoft ACPI-Compliant System
IRQ 129	Microsoft ACPI-Compliant System
IRQ 130	Microsoft ACPI-Compliant System
IRQ 131	Microsoft ACPI-Compliant System
IRQ 132	Microsoft ACPI-Compliant System
IRQ 133	Microsoft ACPI-Compliant System
IRQ 134	Microsoft ACPI-Compliant System
IRQ 135	Microsoft ACPI-Compliant System
IRQ 136	Microsoft ACPI-Compliant System
IRQ 137	Microsoft ACPI-Compliant System
IRQ 138	Microsoft ACPI-Compliant System
IRQ 139	Microsoft ACPI-Compliant System
IRQ 140	Microsoft ACPI-Compliant System
IRQ 141	Microsoft ACPI-Compliant System
IRQ 142	Microsoft ACPI-Compliant System
IRQ 143	Microsoft ACPI-Compliant System
IRQ 144	Microsoft ACPI-Compliant System
IRQ 145	Microsoft ACPI-Compliant System

IRQ	Assignment
IRQ 146	Microsoft ACPI-Compliant System
IRQ 147	Microsoft ACPI-Compliant System
IRQ 148	Microsoft ACPI-Compliant System
IRQ 149	Microsoft ACPI-Compliant System
IRQ 150	Microsoft ACPI-Compliant System
IRQ 151	Microsoft ACPI-Compliant System
IRQ 152	Microsoft ACPI-Compliant System
IRQ 153	Microsoft ACPI-Compliant System
IRQ 154	Microsoft ACPI-Compliant System
IRQ 155	Microsoft ACPI-Compliant System
IRQ 156	Microsoft ACPI-Compliant System
IRQ 157	Microsoft ACPI-Compliant System
IRQ 158	Microsoft ACPI-Compliant System
IRQ 159	Microsoft ACPI-Compliant System
IRQ 160	Microsoft ACPI-Compliant System
IRQ 161	Microsoft ACPI-Compliant System
IRQ 162	Microsoft ACPI-Compliant System
IRQ 163	Microsoft ACPI-Compliant System
IRQ 164	Microsoft ACPI-Compliant System
IRQ 165	Microsoft ACPI-Compliant System
IRQ 166	Microsoft ACPI-Compliant System
IRQ 167	Microsoft ACPI-Compliant System
IRQ 168	Microsoft ACPI-Compliant System
IRQ 169	Microsoft ACPI-Compliant System
IRQ 170	Microsoft ACPI-Compliant System
IRQ 171	Microsoft ACPI-Compliant System
IRQ 172	Microsoft ACPI-Compliant System

IRQ	Assignment
IRQ 173	Microsoft ACPI-Compliant System
IRQ 174	Microsoft ACPI-Compliant System
IRQ 175	Microsoft ACPI-Compliant System
IRQ 176	Microsoft ACPI-Compliant System
IRQ 177	Microsoft ACPI-Compliant System
IRQ 178	Microsoft ACPI-Compliant System
IRQ 179	Microsoft ACPI-Compliant System
IRQ 180	Microsoft ACPI-Compliant System
IRQ 181	Microsoft ACPI-Compliant System
IRQ 182	Microsoft ACPI-Compliant System
IRQ 183	Microsoft ACPI-Compliant System
IRQ 184	Microsoft ACPI-Compliant System
IRQ 185	Microsoft ACPI-Compliant System
IRQ 186	Microsoft ACPI-Compliant System
IRQ 187	Microsoft ACPI-Compliant System
IRQ 188	Microsoft ACPI-Compliant System
IRQ 189	Microsoft ACPI-Compliant System
IRQ 190	Microsoft ACPI-Compliant System
IRQ 191	Microsoft ACPI-Compliant System
IRQ 192	Microsoft ACPI-Compliant System
IRQ 193	Microsoft ACPI-Compliant System
IRQ 194	Microsoft ACPI-Compliant System
IRQ 195	Microsoft ACPI-Compliant System
IRQ 196	Microsoft ACPI-Compliant System
IRQ 197	Microsoft ACPI-Compliant System
IRQ 198	Microsoft ACPI-Compliant System
IRQ 199	Microsoft ACPI-Compliant System

IRQ	Assignment
IRQ 200	Microsoft ACPI-Compliant System
IRQ 201	Microsoft ACPI-Compliant System
IRQ 202	Microsoft ACPI-Compliant System
IRQ 203	Microsoft ACPI-Compliant System
IRQ 204	Microsoft ACPI-Compliant System
IRQ 256	Microsoft ACPI-Compliant System
IRQ 257	Microsoft ACPI-Compliant System
IRQ 258	Microsoft ACPI-Compliant System
IRQ 259	Microsoft ACPI-Compliant System
IRQ 260	Microsoft ACPI-Compliant System
IRQ 261	Microsoft ACPI-Compliant System
IRQ 262	Microsoft ACPI-Compliant System
IRQ 263	Microsoft ACPI-Compliant System
IRQ 264	Microsoft ACPI-Compliant System
IRQ 265	Microsoft ACPI-Compliant System
IRQ 266	Microsoft ACPI-Compliant System
IRQ 267	Microsoft ACPI-Compliant System
IRQ 268	Microsoft ACPI-Compliant System
IRQ 269	Microsoft ACPI-Compliant System
IRQ 270	Microsoft ACPI-Compliant System
IRQ 271	Microsoft ACPI-Compliant System
IRQ 272	Microsoft ACPI-Compliant System
IRQ 273	Microsoft ACPI-Compliant System
IRQ 274	Microsoft ACPI-Compliant System
IRQ 275	Microsoft ACPI-Compliant System
IRQ 276	Microsoft ACPI-Compliant System
IRQ 277	Microsoft ACPI-Compliant System

IRQ	Assignment
IRQ 278	Microsoft ACPI-Compliant System
IRQ 279	Microsoft ACPI-Compliant System
IRQ 280	Microsoft ACPI-Compliant System
IRQ 281	Microsoft ACPI-Compliant System
IRQ 282	Microsoft ACPI-Compliant System
IRQ 283	Microsoft ACPI-Compliant System
IRQ 284	Microsoft ACPI-Compliant System
IRQ 285	Microsoft ACPI-Compliant System
IRQ 286	Microsoft ACPI-Compliant System
IRQ 287	Microsoft ACPI-Compliant System
IRQ 288	Microsoft ACPI-Compliant System
IRQ 289	Microsoft ACPI-Compliant System
IRQ 290	Microsoft ACPI-Compliant System
IRQ 291	Microsoft ACPI-Compliant System
IRQ 292	Microsoft ACPI-Compliant System
IRQ 293	Microsoft ACPI-Compliant System
IRQ 294	Microsoft ACPI-Compliant System
IRQ 295	Microsoft ACPI-Compliant System
IRQ 296	Microsoft ACPI-Compliant System
IRQ 297	Microsoft ACPI-Compliant System
IRQ 298	Microsoft ACPI-Compliant System
IRQ 299	Microsoft ACPI-Compliant System
IRQ 300	Microsoft ACPI-Compliant System
IRQ 301	Microsoft ACPI-Compliant System
IRQ 302	Microsoft ACPI-Compliant System
IRQ 303	Microsoft ACPI-Compliant System
IRQ 304	Microsoft ACPI-Compliant System

IRQ	Assignment
IRQ 305	Microsoft ACPI-Compliant System
IRQ 306	Microsoft ACPI-Compliant System
IRQ 307	Microsoft ACPI-Compliant System
IRQ 308	Microsoft ACPI-Compliant System
IRQ 309	Microsoft ACPI-Compliant System
IRQ 310	Microsoft ACPI-Compliant System
IRQ 311	Microsoft ACPI-Compliant System
IRQ 312	Microsoft ACPI-Compliant System
IRQ 313	Microsoft ACPI-Compliant System
IRQ 314	Microsoft ACPI-Compliant System
IRQ 315	Microsoft ACPI-Compliant System
IRQ 316	Microsoft ACPI-Compliant System
IRQ 317	Microsoft ACPI-Compliant System
IRQ 318	Microsoft ACPI-Compliant System
IRQ 319	Microsoft ACPI-Compliant System
IRQ 320	Microsoft ACPI-Compliant System
IRQ 321	Microsoft ACPI-Compliant System
IRQ 322	Microsoft ACPI-Compliant System
IRQ 323	Microsoft ACPI-Compliant System
IRQ 324	Microsoft ACPI-Compliant System
IRQ 325	Microsoft ACPI-Compliant System
IRQ 326	Microsoft ACPI-Compliant System
IRQ 327	Microsoft ACPI-Compliant System
IRQ 328	Microsoft ACPI-Compliant System
IRQ 329	Microsoft ACPI-Compliant System
IRQ 330	Microsoft ACPI-Compliant System
IRQ 331	Microsoft ACPI-Compliant System

IRQ	Assignment
IRQ 332	Microsoft ACPI-Compliant System
IRQ 333	Microsoft ACPI-Compliant System
IRQ 334	Microsoft ACPI-Compliant System
IRQ 335	Microsoft ACPI-Compliant System
IRQ 336	Microsoft ACPI-Compliant System
IRQ 337	Microsoft ACPI-Compliant System
IRQ 338	Microsoft ACPI-Compliant System
IRQ 339	Microsoft ACPI-Compliant System
IRQ 340	Microsoft ACPI-Compliant System
IRQ 341	Microsoft ACPI-Compliant System
IRQ 342	Microsoft ACPI-Compliant System
IRQ 343	Microsoft ACPI-Compliant System
IRQ 344	Microsoft ACPI-Compliant System
IRQ 345	Microsoft ACPI-Compliant System
IRQ 346	Microsoft ACPI-Compliant System
IRQ 347	Microsoft ACPI-Compliant System
IRQ 348	Microsoft ACPI-Compliant System
IRQ 349	Microsoft ACPI-Compliant System
IRQ 350	Microsoft ACPI-Compliant System
IRQ 351	Microsoft ACPI-Compliant System
IRQ 352	Microsoft ACPI-Compliant System
IRQ 353	Microsoft ACPI-Compliant System
IRQ 354	Microsoft ACPI-Compliant System
IRQ 355	Microsoft ACPI-Compliant System
IRQ 356	Microsoft ACPI-Compliant System
IRQ 357	Microsoft ACPI-Compliant System
IRQ 358	Microsoft ACPI-Compliant System

IRQ	Assignment
IRQ 359	Microsoft ACPI-Compliant System
IRQ 360	Microsoft ACPI-Compliant System
IRQ 361	Microsoft ACPI-Compliant System
IRQ 362	Microsoft ACPI-Compliant System
IRQ 363	Microsoft ACPI-Compliant System
IRQ 364	Microsoft ACPI-Compliant System
IRQ 365	Microsoft ACPI-Compliant System
IRQ 366	Microsoft ACPI-Compliant System
IRQ 367	Microsoft ACPI-Compliant System
IRQ 368	Microsoft ACPI-Compliant System
IRQ 369	Microsoft ACPI-Compliant System
IRQ 370	Microsoft ACPI-Compliant System
IRQ 371	Microsoft ACPI-Compliant System
IRQ 372	Microsoft ACPI-Compliant System
IRQ 373	Microsoft ACPI-Compliant System
IRQ 374	Microsoft ACPI-Compliant System
IRQ 375	Microsoft ACPI-Compliant System
IRQ 376	Microsoft ACPI-Compliant System
IRQ 377	Microsoft ACPI-Compliant System
IRQ 378	Microsoft ACPI-Compliant System
IRQ 379	Microsoft ACPI-Compliant System
IRQ 380	Microsoft ACPI-Compliant System
IRQ 381	Microsoft ACPI-Compliant System
IRQ 382	Microsoft ACPI-Compliant System
IRQ 383	Microsoft ACPI-Compliant System
IRQ 384	Microsoft ACPI-Compliant System
IRQ 385	Microsoft ACPI-Compliant System

IRQ	Assignment
IRQ 386	Microsoft ACPI-Compliant System
IRQ 387	Microsoft ACPI-Compliant System
IRQ 388	Microsoft ACPI-Compliant System
IRQ 389	Microsoft ACPI-Compliant System
IRQ 390	Microsoft ACPI-Compliant System
IRQ 391	Microsoft ACPI-Compliant System
IRQ 392	Microsoft ACPI-Compliant System
IRQ 393	Microsoft ACPI-Compliant System
IRQ 394	Microsoft ACPI-Compliant System
IRQ 395	Microsoft ACPI-Compliant System
IRQ 396	Microsoft ACPI-Compliant System
IRQ 397	Microsoft ACPI-Compliant System
IRQ 398	Microsoft ACPI-Compliant System
IRQ 399	Microsoft ACPI-Compliant System
IRQ 400	Microsoft ACPI-Compliant System
IRQ 401	Microsoft ACPI-Compliant System
IRQ 402	Microsoft ACPI-Compliant System
IRQ 403	Microsoft ACPI-Compliant System
IRQ 404	Microsoft ACPI-Compliant System
IRQ 405	Microsoft ACPI-Compliant System
IRQ 406	Microsoft ACPI-Compliant System
IRQ 407	Microsoft ACPI-Compliant System
IRQ 408	Microsoft ACPI-Compliant System
IRQ 409	Microsoft ACPI-Compliant System
IRQ 410	Microsoft ACPI-Compliant System
IRQ 411	Microsoft ACPI-Compliant System
IRQ 412	Microsoft ACPI-Compliant System

IRQ	Assignment
IRQ 413	Microsoft ACPI-Compliant System
IRQ 414	Microsoft ACPI-Compliant System
IRQ 415	Microsoft ACPI-Compliant System
IRQ 416	Microsoft ACPI-Compliant System
IRQ 417	Microsoft ACPI-Compliant System
IRQ 418	Microsoft ACPI-Compliant System
IRQ 419	Microsoft ACPI-Compliant System
IRQ 420	Microsoft ACPI-Compliant System
IRQ 421	Microsoft ACPI-Compliant System
IRQ 422	Microsoft ACPI-Compliant System
IRQ 423	Microsoft ACPI-Compliant System
IRQ 424	Microsoft ACPI-Compliant System
IRQ 425	Microsoft ACPI-Compliant System
IRQ 426	Microsoft ACPI-Compliant System
IRQ 427	Microsoft ACPI-Compliant System
IRQ 428	Microsoft ACPI-Compliant System
IRQ 429	Microsoft ACPI-Compliant System
IRQ 430	Microsoft ACPI-Compliant System
IRQ 431	Microsoft ACPI-Compliant System
IRQ 432	Microsoft ACPI-Compliant System
IRQ 433	Microsoft ACPI-Compliant System
IRQ 434	Microsoft ACPI-Compliant System
IRQ 435	Microsoft ACPI-Compliant System
IRQ 436	Microsoft ACPI-Compliant System
IRQ 437	Microsoft ACPI-Compliant System
IRQ 438	Microsoft ACPI-Compliant System
IRQ 439	Microsoft ACPI-Compliant System

IRQ	Assignment
IRQ 440	Microsoft ACPI-Compliant System
IRQ 441	Microsoft ACPI-Compliant System
IRQ 442	Microsoft ACPI-Compliant System
IRQ 443	Microsoft ACPI-Compliant System
IRQ 444	Microsoft ACPI-Compliant System
IRQ 445	Microsoft ACPI-Compliant System
IRQ 446	Microsoft ACPI-Compliant System
IRQ 447	Microsoft ACPI-Compliant System
IRQ 448	Microsoft ACPI-Compliant System
IRQ 449	Microsoft ACPI-Compliant System
IRQ 450	Microsoft ACPI-Compliant System
IRQ 451	Microsoft ACPI-Compliant System
IRQ 452	Microsoft ACPI-Compliant System
IRQ 453	Microsoft ACPI-Compliant System
IRQ 454	Microsoft ACPI-Compliant System
IRQ 455	Microsoft ACPI-Compliant System
IRQ 456	Microsoft ACPI-Compliant System
IRQ 457	Microsoft ACPI-Compliant System
IRQ 458	Microsoft ACPI-Compliant System
IRQ 459	Microsoft ACPI-Compliant System
IRQ 460	Microsoft ACPI-Compliant System
IRQ 461	Microsoft ACPI-Compliant System
IRQ 462	Microsoft ACPI-Compliant System
IRQ 463	Microsoft ACPI-Compliant System
IRQ 464	Microsoft ACPI-Compliant System
IRQ 465	Microsoft ACPI-Compliant System
IRQ 466	Microsoft ACPI-Compliant System

IRQ	Assignment
IRQ 467	Microsoft ACPI-Compliant System
IRQ 468	Microsoft ACPI-Compliant System
IRQ 469	Microsoft ACPI-Compliant System
IRQ 470	Microsoft ACPI-Compliant System
IRQ 471	Microsoft ACPI-Compliant System
IRQ 472	Microsoft ACPI-Compliant System
IRQ 473	Microsoft ACPI-Compliant System
IRQ 474	Microsoft ACPI-Compliant System
IRQ 475	Microsoft ACPI-Compliant System
IRQ 476	Microsoft ACPI-Compliant System
IRQ 477	Microsoft ACPI-Compliant System
IRQ 478	Microsoft ACPI-Compliant System
IRQ 479	Microsoft ACPI-Compliant System
IRQ 480	Microsoft ACPI-Compliant System
IRQ 481	Microsoft ACPI-Compliant System
IRQ 482	Microsoft ACPI-Compliant System
IRQ 483	Microsoft ACPI-Compliant System
IRQ 484	Microsoft ACPI-Compliant System
IRQ 485	Microsoft ACPI-Compliant System
IRQ 486	Microsoft ACPI-Compliant System
IRQ 487	Microsoft ACPI-Compliant System
IRQ 488	Microsoft ACPI-Compliant System
IRQ 489	Microsoft ACPI-Compliant System
IRQ 490	Microsoft ACPI-Compliant System
IRQ 491	Microsoft ACPI-Compliant System
IRQ 492	Microsoft ACPI-Compliant System
IRQ 493	Microsoft ACPI-Compliant System

IRQ	Assignment
IRQ 494	Microsoft ACPI-Compliant System
IRQ 495	Microsoft ACPI-Compliant System
IRQ 496	Microsoft ACPI-Compliant System
IRQ 497	Microsoft ACPI-Compliant System
IRQ 498	Microsoft ACPI-Compliant System
IRQ 499	Microsoft ACPI-Compliant System
IRQ 500	Microsoft ACPI-Compliant System
IRQ 501	Microsoft ACPI-Compliant System
IRQ 502	Microsoft ACPI-Compliant System
IRQ 503	Microsoft ACPI-Compliant System
IRQ 504	Microsoft ACPI-Compliant System
IRQ 505	Microsoft ACPI-Compliant System
IRQ 506	Microsoft ACPI-Compliant System
IRQ 507	Microsoft ACPI-Compliant System
IRQ 508	Microsoft ACPI-Compliant System
IRQ 509	Microsoft ACPI-Compliant System
IRQ 510	Microsoft ACPI-Compliant System
IRQ 511	Microsoft ACPI-Compliant System
IRQ 4294967289	Intel(R) I210 Gigabit Network Connection
IRQ 4294967288	Intel(R) I210 Gigabit Network Connection
IRQ 4294967287	Intel(R) I210 Gigabit Network Connection
IRQ 4294967286	Intel(R) I210 Gigabit Network Connection
IRQ 4294967285	Intel(R) I210 Gigabit Network Connection
IRQ 4294967284	Intel(R) I210 Gigabit Network Connection
IRQ	Intel(R) Management Engine Interface

IRQ	Assignment
4294967283	
IRQ 4294967290	Intel(R) USB 3.0 eXtensible Host Controller - 1.0 (Microsoft)
IRQ 4294967292	Intel(R) Ethernet Connection (2) I219-V
IRQ 4294967291	Intel(R) HD Graphics 630
IRQ 4294967293	Standard SATA AHCI Controller
IRQ 4294967294	Intel(R) 100 Series/C230 Series Chipset Family PCI Express Root Port #6 - A115

I/O MAP

I/O Map	Assignment
0x00000A00-0x00000A0F	Motherboard resources
0x00000A10-0x00000A1F	Motherboard resources
0x00000A20-0x00000A2F	Motherboard resources
0x0000002E-0x0000002F	Motherboard resources
0x0000004E-0x0000004F	Motherboard resources
0x00000061-0x00000061	Motherboard resources
0x00000063-0x00000063	Motherboard resources
0x00000065-0x00000065	Motherboard resources
0x00000067-0x00000067	Motherboard resources
0x00000070-0x00000070	Motherboard resources
0x00000070-0x00000070	System CMOS/real time clock
0x00000080-0x00000080	Motherboard resources
0x00000092-0x00000092	Motherboard resources
0x000000B2-0x000000B3	Motherboard resources
0x00000680-0x0000069F	Motherboard resources
0x0000FFFF-0x0000FFFF	Motherboard resources
0x0000FFFF-0x0000FFFF	Motherboard resources
0x0000FFFF-0x0000FFFF	Motherboard resources
0x00001800-0x000018FE	Motherboard resources
0x0000164E-0x0000164F	Motherboard resources
0x00000378-0x0000037F	Printer Port (LPT1)
0x0000F000-0x0000F03F	Intel(R) HD Graphics 630
0x000003B0-0x000003BB	Intel(R) HD Graphics 630
0x000003C0-0x000003DF	Intel(R) HD Graphics 630
0x00000800-0x0000087F	Motherboard resources
0x0000E000-0x0000EFFF	Intel(R) 100 Series/C230 Series Chipset

I/O Map	Assignment
	Family PCI Express Root Port #6 - A115
0x000000F0-0x000000F0	Numeric data processor
0x0000F090-0x0000F097	Standard SATA AHCI Controller
0x0000F080-0x0000F083	Standard SATA AHCI Controller
0x0000F060-0x0000F07F	Standard SATA AHCI Controller
0x000003F8-0x000003FF	Communications Port (COM1)
0x000002F8-0x000002FF	Communications Port (COM2)
0x000003E8-0x000003EF	Communications Port (COM3)
0x000002E8-0x000002EF	Communications Port (COM4)
0x000002F0-0x000002F7	Communications Port (COM5)
0x000002E0-0x000002E7	Communications Port (COM6)
0x00000040-0x00000043	System timer
0x00000050-0x00000053	System timer
0x00000000-0x00000CF7	PCI Express Root Complex
0x00000D00-0x0000FFFF	PCI Express Root Complex
0x0000FF00-0x0000FFFE	Motherboard resources
0x0000F040-0x0000F05F	Intel(R) 100 Series/C230 Series Chipset Family SMBus - A123
0x00000020-0x00000021	Programmable interrupt controller
0x00000024-0x00000025	Programmable interrupt controller
0x00000028-0x00000029	Programmable interrupt controller
0x0000002C-0x0000002D	Programmable interrupt controller
0x00000030-0x00000031	Programmable interrupt controller
0x00000034-0x00000035	Programmable interrupt controller
0x00000038-0x00000039	Programmable interrupt controller
0x0000003C-0x0000003D	Programmable interrupt controller
0x000000A0-0x000000A1	Programmable interrupt controller

I/O Map	Assignment
0x000000A4-0x000000A5	Programmable interrupt controller
0x000000A8-0x000000A9	Programmable interrupt controller
0x000000AC-0x000000AD	Programmable interrupt controller
0x000000B0-0x000000B1	Programmable interrupt controller
0x000000B4-0x000000B5	Programmable interrupt controller
0x000000B8-0x000000B9	Programmable interrupt controller
0x000000BC-0x000000BD	Programmable interrupt controller
0x000004D0-0x000004D1	Programmable interrupt controller
0x00001854-0x00001857	Motherboard resources

DMA Channels Map

DMA Channels Map	Assignment
Channel 3	Printer Port (LPT1)

Memory Map

Memory Map	Assignment
0xFED10000-0xFED17FFF	Motherboard resources
0xFED18000-0xFED18FFF	Motherboard resources
0xFED19000-0xFED19FFF	Motherboard resources
0xE0000000-0xEFFFFFFF	Motherboard resources
0xFED20000-0xFED3FFFF	Motherboard resources
0xFED90000-0xFED93FFF	Motherboard resources
0xFED45000-0xFED8FFFF	Motherboard resources
0xFF000000-0xFFFFFFFF	Motherboard resources
0xFF000000-0xFFFFFFFF	Legacy device
0xFEE00000-0xFEEFFFFFFF	Motherboard resources
0xDFFE0000-0xDFFFFFFF	Motherboard resources
0xFDAF0000-0xFDAFFFFFFF	Motherboard resources
0xFDAE0000-0xFDAEFFFF	Motherboard resources
0xFDAC0000-0xFDACFFFF	Motherboard resources
0xDE000000-0xDEFFFFFFF	Intel(R) HD Graphics 630
0xC0000000-0xCFFFFFFF	Intel(R) HD Graphics 630
0xA0000-0xBFFFF	Intel(R) HD Graphics 630
0xA0000-0xBFFFF	PCI Express Root Complex
0xDF000000-0xDF0FFFFF	Intel(R) 100 Series/C230 Series Chipset Family PCI Express Root Port #6 - A115
0xDF000000-0xDF0FFFFF	Intel(R) I210 Gigabit Network Connection
0xFED00000-0xFED003FF	High precision event timer
0xDF148000-0xDF149FFF	Standard SATA AHCI Controller
0xDF14C000-0xDF14C0FF	Standard SATA AHCI Controller
0xDF14B000-0xDF14B7FF	Standard SATA AHCI Controller

Memory Map	Assignment
0xFD000000-0xFDABFFFF	Motherboard resources
0xFD000000-0xFDABFFFF	PCI Express Root Complex
0xFDAD0000-0xFDADFFFF	Motherboard resources
0xFDB00000-0xFDFFFFFFFF	Motherboard resources
0xFE000000-0xFE01FFFF	Motherboard resources
0xFE036000-0xFE03BFFF	Motherboard resources
0xFE03D000-0xFE3FFFFFFF	Motherboard resources
0xFE410000-0xFE7FFFFFFF	Motherboard resources
0xDF144000-0xDF147FFF	Intel(R) 100 Series/C230 Series Chipset Family PMC - A121
0x90000000-0xDFFFFFFF	PCI Express Root Complex
0xDF080000-0xDF083FFF	Intel(R) I210 Gigabit Network Connection
0xFE40F000-0xFE40FFFF	Intel(R) Management Engine Interface
0xDF130000-0xDF13FFFF	Intel(R) USB 3.0 eXtensible Host Controller - 1.0 (Microsoft)
0xDF14A000-0xDF14A0FF	Intel(R) 100 Series/C230 Series Chipset Family SMBus - A123
0xDF100000-0xDF11FFFF	Intel(R) Ethernet Connection (2) I219-V
0xDF14E000-0xDF14EFFF	Intel(R) 100 Series/C230 Series Chipset Family Thermal subsystem - A131
0xDF140000-0xDF143FFF	High Definition Audio Controller
0xDF120000-0xDF12FFFF	High Definition Audio Controller

Configuring WatchDog Timer

The I/O port address of the watchdog timer is 2E (hex) and 2F (hex). 2E (hex) is the address port. 2F (hex) is the data port. User must first assign the address of register by writing address value into address port 2E (hex), then write/read data to/from the assigned register through data port 2F (hex).

Configuration Sequence

To program F81866 configuration registers, the following configuration sequence must be followed:

(1) Enter the extended function mode

To place the chip into the Extended Function Mode, two successive writes of 0x87 must be applied to Extended Function Enable Registers (EFERs, i.e. 2Eh or 4Eh).

(2) Configure the configuration registers

The chip selects the Logical Device and activates the desired Logical Devices through Extended Function Index Register (EFIR) and Extended Function Data Register (EFDR). The EFIR is located at the same address as the EFER, and the EFDR is located at address (EFIR+1). First, write the Logical Device Number (i.e. 0x07) to the EFIR and then write the number of the desired Logical Device to the EFDR. If accessing the Chip (Global) Control Registers, this step is not required. Secondly, write the address of the desired configuration register within the Logical Device to the EFIR and then write (or read) the desired configuration register through the EFDR.

(3) Exit the extended function mode

To exit the Extended Function Mode, writing 0xAA to the EFER is required. Once the chip exits the Extended Function Mode, it is in the normal running mode and is ready to enter the configuration mode.

Code example for watch dog timer

Enable watchdog timer and set timeout interval to 30 seconds.

```
;----- Enter to extended function mode -----
mov     dx, 2eh
mov     al, 87h
out     dx, al
out     dx, al
;----- Select Logical Device 7 of watchdog timer -----
mov     al, 07h
out     dx, al
inc     dx
mov     al, 07h
out     dx, al
;----- Enable Watch dog feature -----
mov     al, 030h
out     dx, al
inc     dx
mov     al, 01h
out     dx, al
;----- Set timeout interval as 30 seconds -----
dec     dx
mov     al, 0F6h
out     dx, al
inc     dx
mov     al, 1Eh
out     dx, al
;----- Enable Watch PME-----
dec     dx
mov     al, 0FAh
out     dx, al
inc     dx
in      al, dx
or      al, 51h
out     dx, al
;----- Set second as counting unit and start counting -----
dec     dx
mov     al, 0F5h
out     dx, al
inc     dx
in      al, dx
and     al, 0F7h
or      al, 20h
out     dx, al
;----- Exit the extended function mode -----
dec     dx
mov     al, 0AAh
out     dx, al
```



Flash BIOS Update

I. Prerequisites

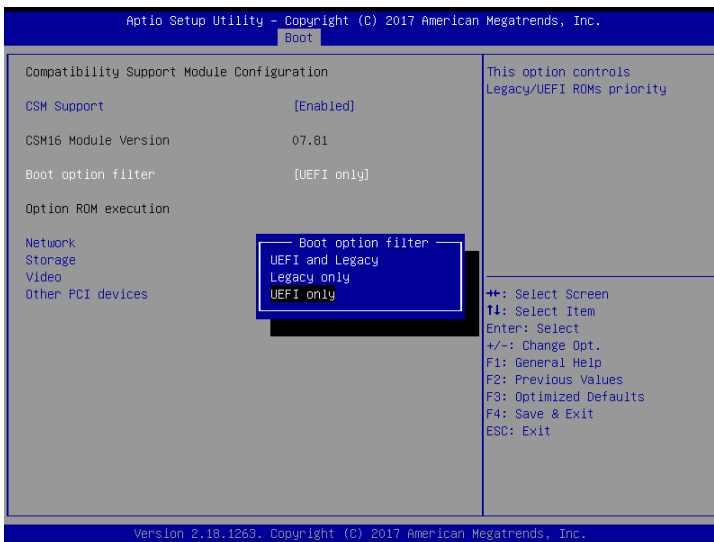
- 1 Prepare a USB storage device to save the required files for BIOS update.
- 2 Download and save the BIOS file (e.g. 57000PH2.bin) to the storage device.
- 3 Copy AMI flash utility – AFUEFIx64.exe (v5.09.01) into the storage device. The utility and BIOS file should be saved to the same path.
- 4 Make sure the targeted system can first boot to the EFI shell environment.
 - (1) Connect the USB storage device.
 - (2) Turn on the computer and press <ESC> or key during boot to enter BIOS Setup.
 - (3) The system will go into the BIOS setup menu.
 - (4) Select [**Boot**] menu and enter into [**CSM Configuration**] menu.
 - (5) Set [**Boot option filter**] to [**UEFI Only**] and press <F4> to save the configuration and restart the system.

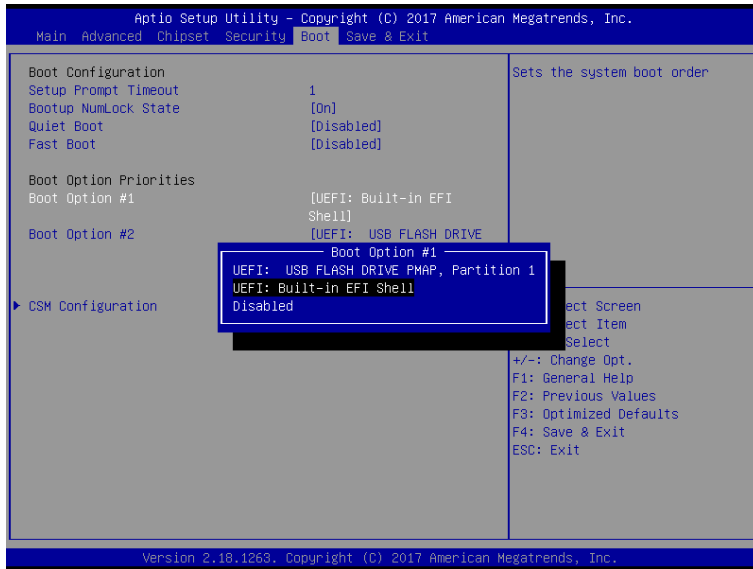

- (6) Press <ESC> or to enter BIOS setup menu again.
- (7) Select [Boot] menu and set [UEFI: Built-in EFI Shell] to be the 1st boot device.
- (8) Press <F4> to save the configuration and restart the system to boot into EFI Shell environment.



II. AFUEFIx64 Command for System BIOS Update

AFUEFIx64.efi is the AMI firmware update utility; the command line is shown as below:

AFUEFIx64 <ROM File Name> [option1] [option2]....

Users can type “AFUEFIx64 /?” to view the definition of each control option. The recommended options for BIOS ROM update include the following parameters:

- /P:** Program main BIOS image.
- /B:** Program Boot Block.
- /N:** Program NVRAM.
- /X:** Don't check ROM ID.

III. BIOS Update Procedure

1 Boot into EFI Shell, change to the path where you put BIOS image and AFUEFIx64.

```
Shell> fs0:  
fs0:\> cd afuefix64
```

- 2** Type "AFUEFIx64 5700xxxx.bin /p /b /n /x" and press Enter to start the flash procedure. (xxxx means the BIOS revision part, e.g. 0PH1...)
- 3** During the update procedure, you will see the BIOS update process status and the percentage it has been updated. **Beware!** Do not turn off system power or reset your computer if the whole update procedure is not completed yet, or it may crash the BIOS ROM and the system will be unable to boot up next time.
- 4** After BIOS update procedure is completed, the following messages will be shown:

```
fs0:\afuefix64> afuefix64 57000PH2.bin /p /b /n /x
+-----+
|          AMI Firmware Update Utility  v5.09.01.1317          |
| Copyright (C) 2016 American Megatrends Inc. All Rights Reserved. |
+-----+
Reading flash ..... done
- ME Data Size Checking . ok
- FFS checksums ..... ok
- Check RomLayout ..... Ok.
Erasing Boot Block ..... done
Updating Boot Block ..... done
Verifying Boot Block ..... done
Erasing Main Block ..... done
Updating Main Block ..... done
Verifying Main Block ..... done
Erasing NVRAM Block ..... done
Updating NVRAM Block ..... done
Verifying NVRAM Block ..... done

fs0:\afuefix64> _
```

- 5 Restart the system and boot up with the new BIOS configuration.
- 6 The BIOS Update is completed after the system is restarted.
- 7 Reboot the system and verify if the BIOS version shown on the initialization screen has been updated.

