

USER MANUAL

SP-6558/6550

Intel® Atom® / Pentium® /
Celeron® Processor Fanless and
Low Power 8.4" & 10.4" Panel PC

SP-6558/SP-6550 M1

SP-6558 / SP-6550

8.4"/10.4" High Performance Panel PC

COPYRIGHT NOTICE & TRADEMARK

All trademarks and registered trademarks mentioned herein are the property of their respective owners.

This manual is copyrighted in Sep. 2018. You may not reproduce or transmit in any form or by any means, electronic, or mechanical, including photocopying and recording.

DISCLAIMER

This user's manual is meant to assist users in installing and setting up the system. The information contained in this document is subject to change without any notice.

CE NOTICE

This is a class A product. In a domestic environment this product may cause radio interference in which case the user may be required to take adequate measures.

FCC NOTICE

This equipment has been tested and found to comply with the limits for a Class A digital device, pursuant to part 15 of the FCC Rules. These limits are designed to provide reasonable protection against harmful interference when the equipment is operated in a commercial environment. This equipment generates, uses, and can radiate radio frequency energy and, if not installed and used in accordance with the instruction manual, may cause harmful interference to radio communications. Operation of this equipment in a residential area is likely to cause harmful interference in which case the user will be required to correct the interference at his own expense.

You are cautioned that any change or modifications to the equipment not expressly approve by the party responsible for compliance could void your authority to operate such equipment.



CAUTION: Danger of explosion may occur when the battery is incorrectly replaced. Replace the battery only with the same or equivalent type recommended by the manufacturer. Dispose of used batteries according to the manufacturer's instructions.



WARNING: Some internal parts of the system may have high electrical voltage. We strongly recommend that only qualified engineers are allowed to service and disassemble the system. If any damages should occur on the system and are caused by unauthorized servicing, it will not be covered by the product warranty.

Contents

Revision History	vi
1 Introduction	1-1
1.1 About This Manual	1-2
2 Getting Started	2-1
2.1 Package List.....	2-2
2.2 System Overview	2-3
2.3 System Specifications	2-7
2.4 Safety Precautions	2-9
3 System Configuration.....	3-1
3.1 External I/O Ports Diagram	3-2
3.1.1 SP-6558 / 6550 Rear I/O Ports Diagram	3-2
3.2 JUMPER & CONNECTOR QUICK REFERENCE TABLE	3-3
3.3 COMPONENT LOCATIONS OF SYSTEM MAIN BOARD	3-5
3.3.1 Top View of System Main Board SB-8134.....	3-5
3.3.2 Bottom View of System Main Board	3-7
3.4 HOW TO SET JUMPERS	3-8
3.5 Setting Main Board Connectors and Jumpers	3-10
3.5.1 COM Connector	3-10
3.5.2 COM1 and COM2 PIN9 Definition Selection Guide	3-11
3.5.3 Power Input Connector	3-12
3.5.4 Power Button Connector.....	3-12
3.5.5 LAN1, LAN2 Ports.....	3-13
3.5.6 Dual USB 3.0 Connectors.....	3-15

3.5.7	USB 3.0 Connector	3-16
3.5.8	Digital Input/Output Connector	3-17
3.5.9	I2C Wafer	3-18
3.5.10	I2C PIN2 Voltage Selection	3-19
3.5.11	DVI Port	3-20
3.5.12	HDMI Port Connector	3-21
3.5.13	HD Audio Connector	3-22
3.5.14	Low Pin Count (LPC) Connector	3-23
3.5.15	Power over Ethernet (PoE) Connector	3-23
3.5.16	MINI PCI EXPRESS SLOT	3-24
3.5.17	LVDS Connector	3-25
3.5.18	Panel Inverter Connector	3-26
3.5.19	Mini-Serial ATA (SATA) SLOT	3-27
3.5.20	Serial ATA (SATA) 3.0 Connector.....	3-28
3.5.21	HDD Power Connector	3-28
3.5.22	AT / ATX Mode Selection	3-29
3.5.23	TPM Module Selection.....	3-29
3.5.24	Slide Switch For LVDS Resolution Selection.....	3-30
3.5.25	LVDS Display Selection	3-33
3.5.26	LVDS VCC Voltage Selection	3-34
3.5.27	LVDS Backlight Control Selection.....	3-35
3.5.28	LVDS Panel On/Off Sequence Selection.....	3-36
3.5.29	LVDS Panel Inverter 12V Soft-Start Time Selection.....	3-37
3.5.30	CLEAR CMOS DATA SELECTION.....	3-38
3.5.31	MicroSD Card Connector.....	3-39
3.5.32	SIM Card Connectors	3-40
3.6	TOUCH CONTROL BOARD SR-6145 CONNECTOR QUICK REFERENCE TABLE	3-41

3.7	TOUCH CONTROL BOARD SR-6145 COMPONENT LOCATIONS.....	3-41
3.7.1	TOUCH CONTROL Board SR-6145 Top View	3-41
3.8	SETTING TOUCH CONTROL BOARD SR-6145 CONNECTORS AND JUMPERS	3-42
3.8.1	Control Signal Connector.....	3-42
3.8.2	LVDS Panel Signal Connector (Connected To Motherboard)..	3-43
3.8.3	LVDS Panel Signal Connector (Connected To LCD Panel).....	3-44
3.8.4	15" Panel LED Backlight Control Connector	3-45
3.8.5	Touch Panel Connector	3-45
3.8.6	LED1 Connector	3-46
3.8.7	Touch Panel Up Signal Setting	3-47
3.8.8	Touch Panel Low Signal Setting	3-48
4	Software Utilities	4-1
4.1	Introduction.....	4-2
4.2	Installing Intel® Chipset Software Installation Utility.....	4-4
4.2.1	Introduction	4-4
4.2.2	Intel® Chipset Software Installation Utility.....	4-4
4.3	Installing Intel® Trusted Execution Engine Installation Utility	4-5
4.4	Installing Graphics Driver Utility	4-5
4.5	Installing LAN Driver Utility.....	4-6
4.6	Installing Sound Driver Utility	4-7
4.7	Installing Intel® Serial I/O Driver Utility.....	4-8
4.8	Installing Microsoft Hotfix kb3211320 and kb3213986 Driver Utility	

.....	4-8
5 BIOS SETUP	5-1
5.1 Introduction.....	5-2
5.2 Accessing Setup Utility.....	5-4
5.3 Main.....	5-7
5.4 Advanced	5-9
5.4.1 Advanced – ACPI Settings.....	5-10
5.4.2 Advanced – Hardware Monitor	5-11
5.4.3 Advanced – F81946 Watchdog Configuration	5-12
5.4.4 Advanced – CPU Configuration.....	5-13
5.4.5 Advanced – F81946 Super I/O Configuration.....	5-17
5.4.6 Advanced – Network Stack Configuration	5-20
5.4.7 Advanced – USB Configuration	5-21
5.4.8 Advanced - Platform Trust Technology	5-22
5.5 Chipset.....	5-23
5.5.1 Chipset – North Bridge	5-24
5.5.2 Chipset – South Bridge	5-25
5.6 Security	5-35
5.7 Boot.....	5-37
5.8 Save & Exit.....	5-39
 Appendix A System Diagrams	 A-1
SP-6558 System Exploded Diagram.....	A-2
SP-6558 Touch Panel Exploded Diagram	A-3
SP-6558 LCD Panel Exploded Diagram	A-4
SP-6558 Panel Module Assembly Exploded Diagram (1).....	A-5

SP-6558 Panel Module Assembly Exploded Diagram (2).....	A-6
SP-6558 Speaker Exploded Diagram	A-7
SP-6550 System Exploded Diagram	A-8
SP-6550 Touch Panel Exploded Diagram	A-9
SP-6550 LCD Panel Exploded Diagram	A-10
SP-6550 Control Board Exploded Diagram.....	A-11
SP-6558 / SP-6550 Wall O-ring Installation Exploded Diagram	A-12
SP-6558 Hook Installation Exploded Diagram (1).....	A-13
SP-6558 Hook Installation Exploded Diagram (2).....	A-14
SP-6558 Wall Mount Installation Exploded Diagram.....	A-15
SP-6550 Hook Installation Exploded Diagram (1).....	A-16
SP-6550 Hook Installation Exploded Diagram (2).....	A-17
SP-6550 Hook Installation Exploded Diagram (3).....	A-18
SP-6550 VESA Mount Installation Exploded Diagram	A-19
SP-6558 / 6550 Heat Sink Exploded Diagram	A-20
SP-6558 / 6550 Front & Rear I/O Panels Installation Exploded Diagram	A-21
SP-6558 / 6550 Mother Board Exploded Diagram	A-23
SP-6558 / 6550 HDD Module Exploded Diagram	A-24
SP-6558 / 6550 Packing Exploded Diagram	A-25

Appendix B Technical SummaryB-1

System Block Diagram	B-2
Interrupt Map	B-3
I/O MAP	B-16
Memory Map.....	B-18
Configuring WatchDog Timer	B-20
Flash BIOS Update.....	B-23

Revision History

The revision history of SP-6558 / SP-6550 User Manual is described below:

Version No.	Revision History	Page No.	Date
M1	Initial Release	-	2018/09

1

Introduction

This chapter provides the introduction for the SP-6558 / 6550 system as well as the framework of the user manual.

The following topic is included:

- About This Manual

1.1 About This Manual

Thank you for purchasing our SP-6558/6550 system. The SP-6558/6550 is an updated system designed to be comparable with the highest performance of IBM AT personal computers. The SP-6558/6550 provides faster processing speed, greater expandability and can handle more tasks than before. This manual is designed to assist you how to install and set up the whole system. It contains 5 chapters and 2 appendixes. Users can configure the system according to their own needs. This user manual is intended for service personnel with strong hardware background. It is not intended for general users.

The following section describes the structure of this user manual.

Chapter 1 Introduction

This chapter introduces the framework of this user manual.

Chapter 2 Getting Started

This chapter describes the package contents and system specifications, and illustrates the physical appearances for the SP-6558/6550 system. Read the safety reminders carefully on how to take care of your system properly.

Chapter 3 System Configuration

This chapter describes the locations and functions of the system motherboard & touch control board components. You will learn how to properly configure the connectors and system configuration jumpers on the motherboard and touch control board, and configure the system to meet your own needs.

Chapter 4 Software Utilities

This chapter introduces how to install Intel[®] Chipset Software Installation Utility, Intel[®] Trusted Execution Engine Driver Utility, Graphics Driver Utility, LAN Driver Utility, Sound Driver Utility, Intel[®] Serial I/O Driver Utility, and Microsoft Hotfix kb3211320 and kb3213986 Driver Utility.

Chapter 5 BIOS Setup

This chapter provides BIOS setup information.

Appendix A System Diagrams

This appendix provides the exploded diagrams and part numbers of the SP-6558 / 6550.

Appendix B Technical Summary

This appendix provides the information about the system block diagram, allocation maps for system resources, Watchdog Timer Configuration and Flash BIOS Update.

2 Getting Started

This chapter provides the information for the SP-6558/6550 system. It describes how to set up the system quickly and outlines the system specifications.

The following topics are included:

- Package List
- System Overview
- System Specification
- Safety Precautions

Experienced users can go to Chapter 3 System Configuration on page 3-1 for a quick start.

2.1 Package List

If you discover any of the items listed below are damaged or lost, please contact your local distributor immediately.

Item	Q'ty
SP-6558/6550	1
Manual / Driver DVD	1
Quick Guide	1
Terminal Block (2 pins)	1
Wall O-ring	1

2.2 System Overview

SP-6558

Unit: mm

Front View

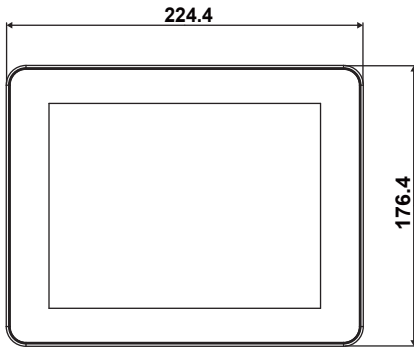

Rear View

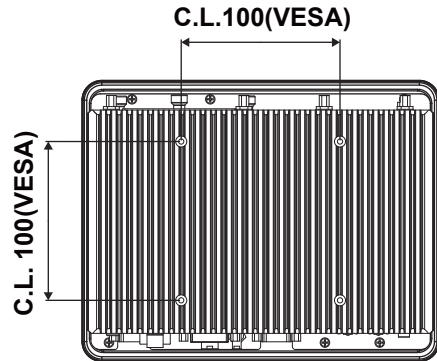

Top View

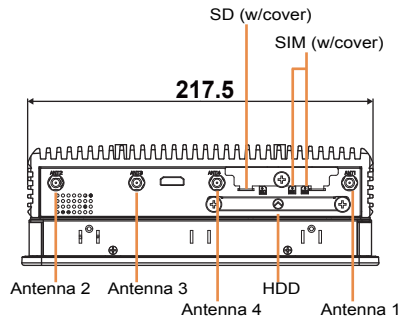

Bottom View

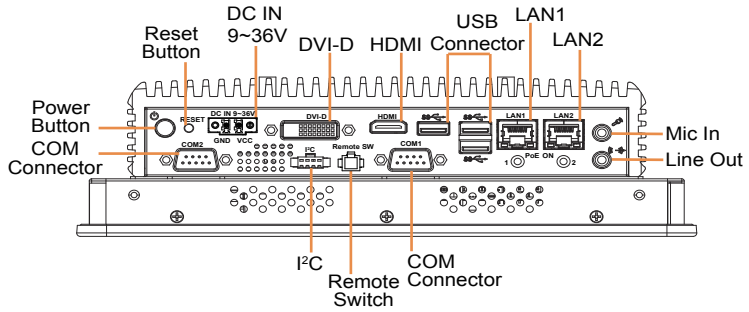

Unit: mm

Left Side View

Right Side View

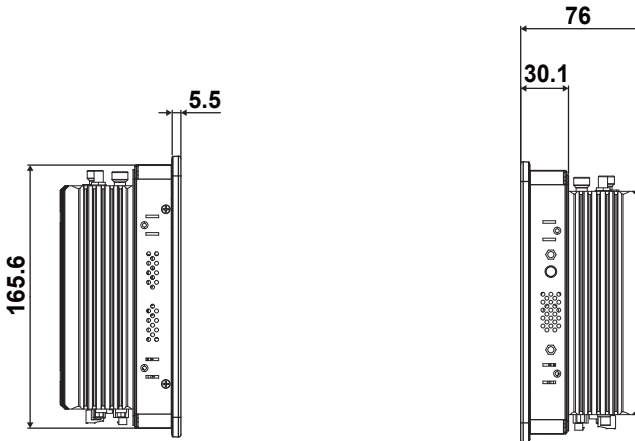

Unit: mm

SP-6550

Front View

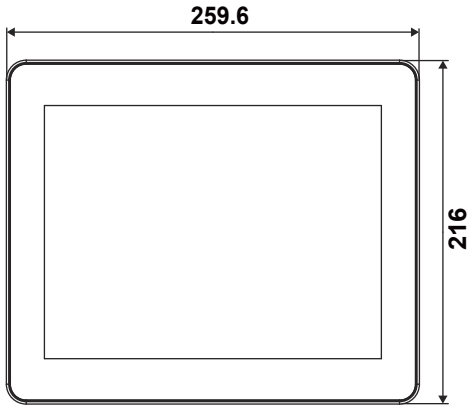

Rear View

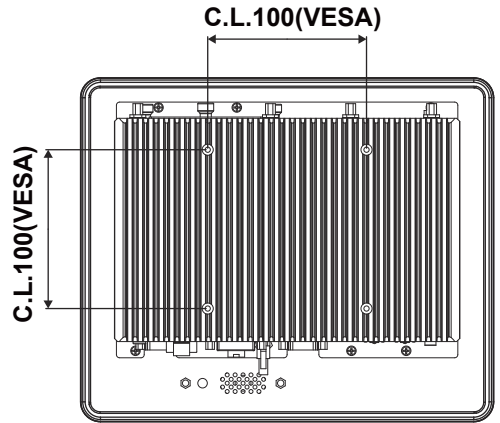

Top View

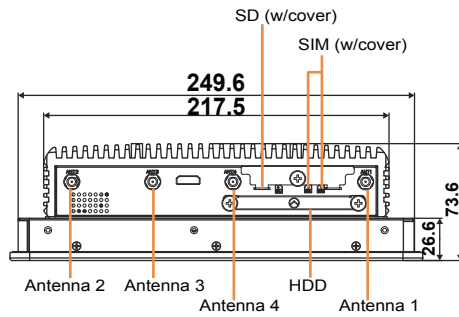

Bottom View

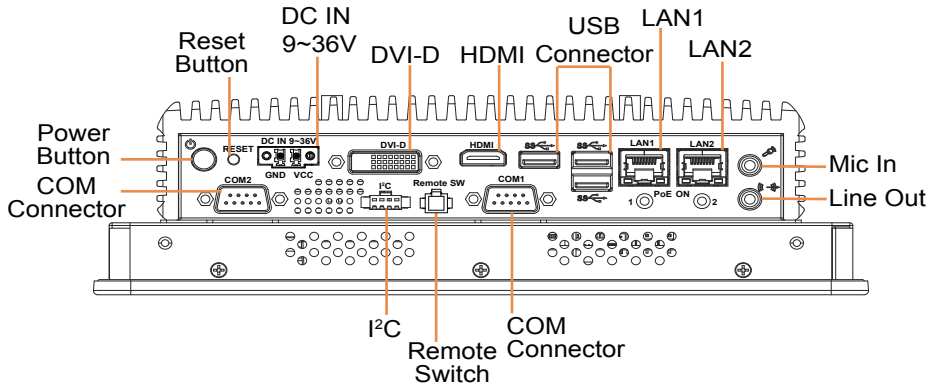

Unit: mm

Left Side View

Right Side View

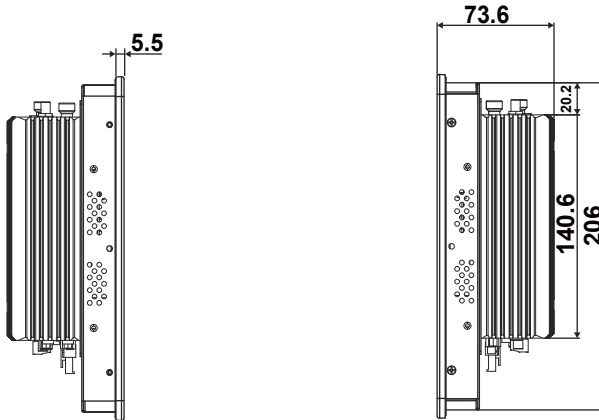

2.3 System Specifications

System	
CPU Type	<ul style="list-style-type: none"> ➤ Intel® Celeron N3350 2C, 2.4GHz ➤ Intel® Pentium N4200 4C, 2.5GHz ➤ Intel® Atom® x7 E3950 4C, 2.0GHz
Memory Support	➤ 1 x DDR3L 1600/1867 SO-DIMM socket (up to 8GB)
Operating System	<ul style="list-style-type: none"> ➤ Windows® 10 IoT Enterprise LTSC 2016 64bit ➤ Ubuntu16.04 LTS
BIOS	➤ AMI SPI BIOS
WatchDog Timer	➤ 1~255 seconds
Buzzer	➤ Supports system beep
Drive Bay	➤ 1 x 2.5" SATAIII HDD or SSD drive space
Power Supply	➤ DC In 9~36V
Mounting Support	➤ Wall Mount/ VESA 100/ Panel Mount
Net Weight & Dimensions (WxHxD)	<ul style="list-style-type: none"> ➤ SP-6558: 2.5kg, 224.4 x 176.4 x 76mm ➤ SP-6550: 3.0kg, 259.6 x 216 x 73.6mm
Certificate	➤ FCC/CE
I/O Ports	
DisplayPort	<ul style="list-style-type: none"> ➤ 1 x HDMI (up to 4K) ➤ 1 x DVI-D
USB	➤ 3 x USB 3.0
Serial Ports	<ul style="list-style-type: none"> ➤ COM1/2 for RS-232/422/485 selectable under BIOS ➤ 5V/12V/RI selectable by jumper
Antenna Holes	➤ 4 x antenna holes
Drive Bay	➤ 1 x 2.5" SATAIII HDD or SSD drive space
Expansion Slots	<ul style="list-style-type: none"> ➤ 1 x Full-sized Mini PCIe (mSATA or 3G/4G card with USB 2.0 signals) ➤ 1 x Full-sized Mini PCIe (PCIe or 3G/4G card with USB 2.0 signals) ➤ 1 x SD slot ➤ 2 x SIM slots
LAN	<ul style="list-style-type: none"> ➤ 2 x LANs with PoE (IEEE 802.3af) as option, Wake-On-LAN, PXE ➤ LAN1: Intel I210IT ➤ LAN2: Intel I210IT

Audio	<ul style="list-style-type: none"> ➤ 1 x Line Out ➤ 1 x Mic In
Power On/Off	<ul style="list-style-type: none"> ➤ 1 x power button ➤ 1 x remote switch
LED	➤ 2 x PoE LED indicators
I ² C	➤ 1 x I ² C port
Display	
LCD	<ul style="list-style-type: none"> ➤ SP-6558: 8.4" TFT LCD(LED) SVGA (resolution: 800 x 600), 600 nits ➤ SP-6550: 10.4" TFT LCD(LED) SVGA (resolution: 800 x 600) , 400 nits
Touchscreen	➤ 5-wire resistive touchscreen or projected capacitive touchscreen (USB interface)
Environment	
Operating Temperature (with airflow)	<ul style="list-style-type: none"> ➤ HDD: 0°C ~ 40°C (32°F ~ 104°F) ➤ SSD: 0°C ~ 45°C (32°F ~ 113°F) <p>Wide Temperature SSD:</p> <ul style="list-style-type: none"> ➤ 0°C ~50°C SSD (without PoE and for N3350, N4200 only) ➤ 0°C ~45°C SSD (with PoE and for N3350, N4200 only) ➤ -20°C ~50°C SSD (without PoE and for E3950 only) ➤ -20°C ~45°C SSD (with PoE and for E3950 only)
Storage Temperature	➤ -30°C ~ 60°C (-22°F ~ 140°F)
Humidity	<ul style="list-style-type: none"> ➤ Operating Humidity: 20%~ 90% ➤ Storage Humidity: 20%~ 95%

2.4 Safety Precautions

Before operating this system, read the following information carefully to protect your systems from damages, and extend the life cycle of the system.

1. Check the Line Voltage
 - The operating voltage for the power supply should be within the range of 100V to 240V AC; otherwise, the system may be damaged.
2. Environmental Conditions
 - Place your SP-6558/6550 on a sturdy, level surface. Be sure to allow enough space around the system to have easy access needs.
 - Avoid installing your SP-6558/6550 system in extremely hot or cold places.
 - Avoid direct sunlight exposure for a long period of time (for example, in a closed car in summer time. Also avoid the system from any heating device.). Or do not use SP-6558/6550 when it has been left outdoors in a cold winter day.
 - Avoid moving the system rapidly from a hot place to a cold place, and vice versa, because condensation may occur inside the system.
 - Protect your SP-6558/6550 from strong vibrations which may cause hard disk failure.
 - Do not place the system too close to any radio-active device. Radio-active device may cause signal interference.
 - Always shut down the operating system before turning off the power.
3. Handling
 - Avoid placing heavy objects on the top of the system.
 - Do not turn the system upside down. This may cause the hard drive to malfunction.
 - Do not allow any objects to fall into this device.
 - If water or other liquid spills into the device, unplug the power cord immediately.
4. Good Care
 - When the outside case gets stained, remove the stains using neutral washing agent with a dry cloth.
 - Never use strong agents such as benzene and thinner to clean the surface of the case.
 - If heavy stains are present, moisten a cloth with diluted neutral washing agent or alcohol and then wipe thoroughly with a dry cloth.
 - If dust is accumulated on the case surface, remove it by using a special vacuum cleaner for computers.

3

System Configuration

This chapter contains helpful information about the jumper & connector settings, and component locations for the main board and touch control board.

The following topics are included:

- Connector & Jumper Quick Reference Table
- System Main Board Component Locations
- How to Set Jumpers
- Setting Main Board Connectors and Jumpers
- Touch Control Board Component Locations
- Setting Touch Control Board Connectors and Jumpers

3.1 External I/O Ports Diagram

3.1.1 SP-6558 / 6550 Rear I/O Ports Diagram

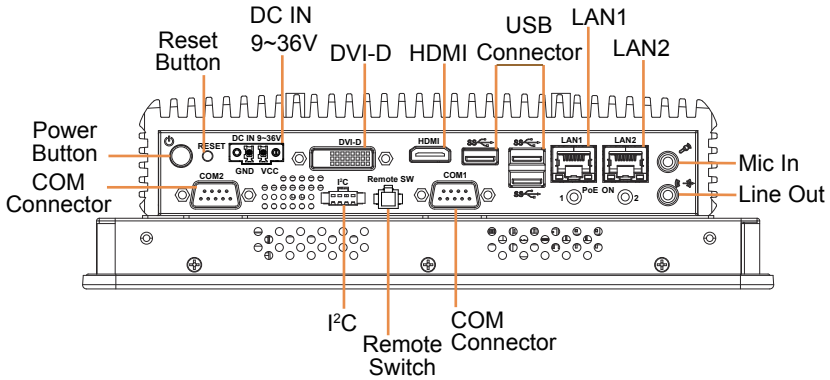

3.2 JUMPER & CONNECTOR QUICK REFERENCE TABLE

JUMPER Description	NAME
AT / ATX Mode Selection	JP_ATX1
COM1 Pin9 RI/5V/12V Selection	JP_COM1
COM2 Pin9 RI/5V/12V Selection	JP_COM2
LVDS Display Selection	JP_EDP1
I2C PIN2 Voltage Selection	JP_I2C1
TPM Module Selection	JP_TPM1
LVDS VCC Voltage Selection	JP_VDD1
Clear CMOS Data Selection	JP4
LVDS Backlight Control Selection	JP6
LVDS Display Selection	JP7
LVDS Panel On/Off Sequence Selection	JP10
LVDS Panel Inverter 12V Soft-Start Time Selection	JP10
Slide Switch for LVDS Resolution Selection	SW2

System CONNECTOR Description	NAME
Rear I/O Port Connectors	
COM Port Connectors	COM1, COM2
LAN1, LAN2 Ports	LAN1, LAN2
Dual USB 3.0 Connectors	USB1
USB 3.0 Connector	USB2
HDMI Connector	HDMI1
DVI (Digital Visual Interface) Connector	DVI1
HD Audio Connector	AUDIO1
Power Input Connector	CN_POWER1
Main Board Top Side Connectors	
Power Button Connector	J_PBTN1
Digital Input/ Output Connector	JDIO1
Mini PCI Express Slot	M_PCIE1
LVDS Connector	LVDS1
Panel Inverter Connector	JINV1

System CONNECTOR Description	NAME
Mini-Serial ATA (SATA) Slot	M_SATA1
SATA 3.0 Connector	SATA1
HDD Power Connector	SATA_PWR1
I2C Wafer	JI2C1, JI2C2
Low Pin Count (LPC) Connector	JLPC1
Power over Ethernet (PoE) Connector	JPOE1
Main Board Bottom Side Connectors	
MicroSD Card Connector	SDCARD1
SIM Card Connectors	SIM1, SIM2

3.3 COMPONENT LOCATIONS OF SYSTEM MAIN BOARD

3.3.1 Top View of System Main Board SB-8134

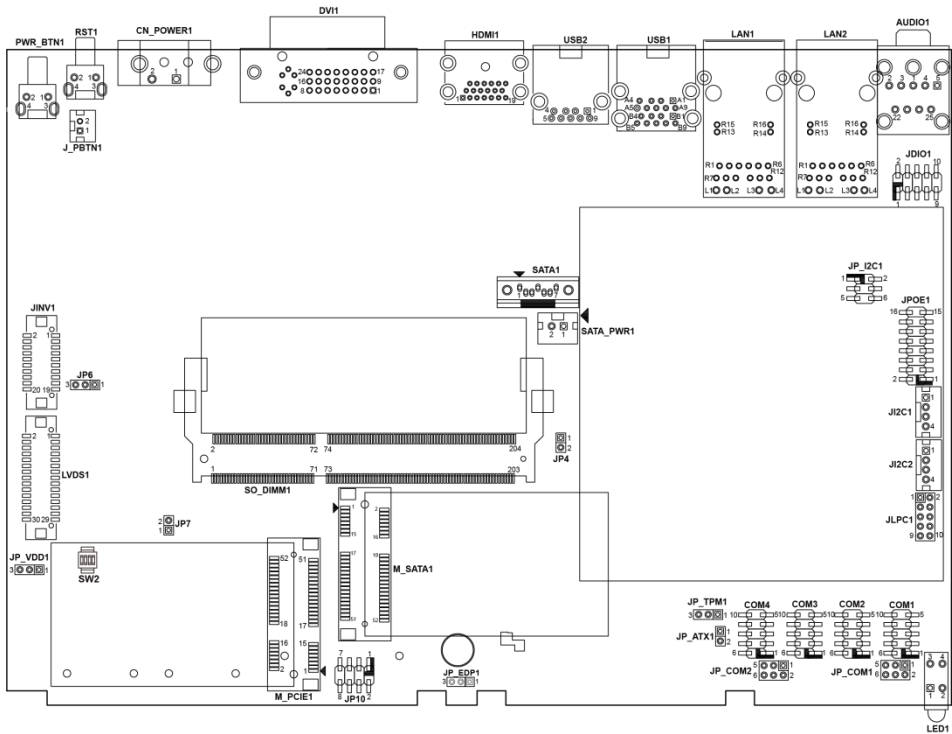





Figure 3-1. Main Board Component Location (Top View)

	<p>WARNING: Always disconnect the power cord when you are working with connectors and jumpers on the main board. Make sure both the system and peripheral devices are turned OFF as sudden surge of power could damage sensitive components. Make sure SP-6558 / SP-6550 is properly grounded.</p>
---	---

	<p>CAUTION: Observe precautions while handling electrostatic sensitive components. Make sure to ground yourself to prevent static charge while you are working on the connectors and jumpers. Use a grounding wrist strap and place all electronic components in any static-shielded devices.</p>
	<p>CAUTION: Always touch the motherboard components by the edges. Never touch components such as a processor by its pins. Take special cares while you are holding electronic circuit boards by the edges only. Do not touch the main board components.</p>

3.3.2 Bottom View of System Main Board

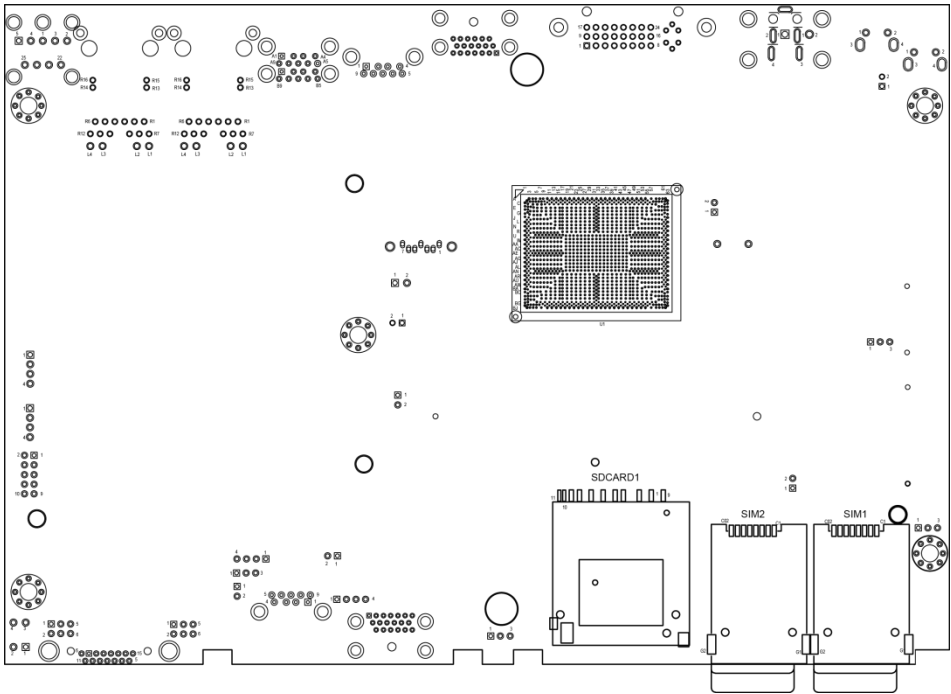

Figure 3-2. Main Board Component Location (Rear View)

3.4 HOW TO SET JUMPERS

You can configure your board by setting the jumpers. A jumper consists of two or three metal pins with a plastic base mounted on the card. By using a small plastic "cap", also known as the jumper cap (with a metal contact inside), you are able to connect the pins. So you can configure your hardware settings by "opening" or "closing" jumpers.

Jumpers can be combined into sets that are called jumper blocks. When jumpers are all in the block, you have to put them together to set up the hardware configuration. The figure below shows what this looks like.

Jumpers & Caps

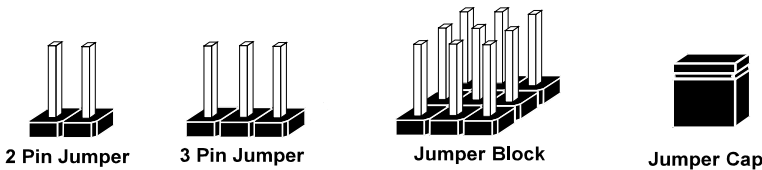

If a jumper has three pins, for example, labeled 1, 2 and 3. You can connect pins 1 and 2 to create one setting and shorting. You can also select to connect pins 2 and 3 to create another setting. The format of the jumper picture will be illustrated throughout this manual. The figure below shows different types of jumpers and jumper settings.

Jumper diagrams



Jumper Cap looks like this

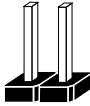

2 pin Jumper looks like this

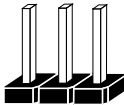

3 pin Jumper looks like this

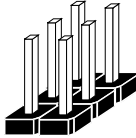
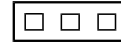

Jumper Block looks like this

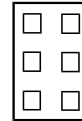

Jumper settings



2 pin Jumper closed(enabled)
looks like this

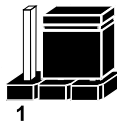

3 pin Jumper
2-3 pin closed(enabled)
looks like this

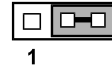

Jumper Block
1-2 pin closed(enabled)
looks like this

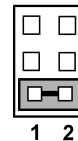

3.5 Setting Main Board Connectors and Jumpers

3.5.1 COM Connector

Connector Location: COM1, COM2

Description: COM Connector

COM1(RS232/RS422/RS485) Connector Pin Assignment:

PIN	ASSIGNMENT		
	RS232 <i>(Default Setting)</i>	RS422	RS485
1	COM1_DCD	TX-	D-
2	COM1_RX	TX+	D+
3	COM1_TX	RX-	X
4	COM1_DTR	RX+	X
5	GND	GND	GND
6	COM1_DSR	X	X
7	COM1_RTS	X	X
8	COM1_CTS	X	X
9	COM1_RI* ¹	X	X

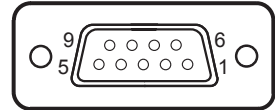

**COM1/
COM2**

COM2 (RS232/RS422/RS485) Connector Pin Assignment:

PIN	ASSIGNMENT		
	RS232 <i>(Default Setting)</i>	RS422	RS485
1	COM2_DCD	TX-	D-
2	COM2_RX	TX+	D+
3	COM2_TX	RX-	X
4	COM2_DTR	RX+	X
5	GND	GND	GND
6	COM2_DSR	X	X
7	COM2_RTS	X	X
8	COM2_CTS	X	X
9	COM2_RI* ¹	X	X

Notes:

1. COM1 and COM2 pin 9 are selectable for RI, +5V or +12V by jumper setting. Default setting is RI, please see “COM1 and COM2 PIN9 Definition Selection Guide” for selection details.
2. COM1 and COM2 are selectable as RS-232, RS-422, RS-485 by BIOS.

3.5.2 COM1 and COM2 PIN9 Definition Selection Guide

Jumper Location: JP_COM1, JP_COM2

Description: COM1 (JP_COM1) and COM2 pin9 (JP_COM2) RI/5V/12V Selection

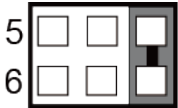
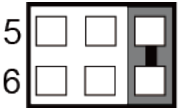
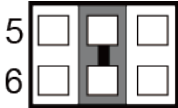
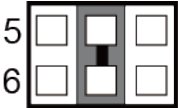
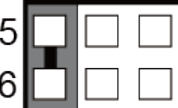
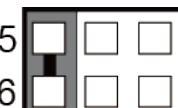
SELECTION	JUMPER SETTING	JUMPER ILLUSTRATION	
RI	1-2 <i>(Default Setting)</i>	 <p>JP_COM1</p>	 <p>JP_COM2</p>
+12V	3-4	 <p>JP_COM1</p>	 <p>JP_COM2</p>
+5V	5-6	 <p>JP_COM1</p>	 <p>JP_COM2</p>

3.5.3 Power Input Connector

Connector Location: CN_POWER1

Description: Power Input Connector

PIN	ASSIGNMENT
1	WIDE_POWERIN
2	GND

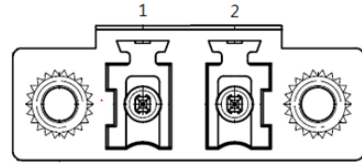

CN_POWER1

3.5.4 Power Button Connector

Connector Location: J_PBTN1

Description: Power Button Connector

PIN	ASSIGNMENT
1	PWRBTNJ
2	GND

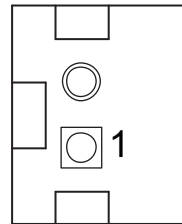

J_PBTN1

3.5.5 LAN1, LAN2 Ports

Port Location: LAN1, LAN2

Description: LAN1, LAN2 Port, LAN RJ45 Port (Rear I/O)

LAN1 Pin Assignment:

PIN	ASSIGNMENT
1	LAN1_MDIP0
2	LAN1_MDIN0
3	LAN1_MDIP1
4	LAN1_MDIP2
5	LAN1_MDIN2
6	LAN1_MDIN1
7	LAN1_MDIP3
8	LAN1_MDIN3

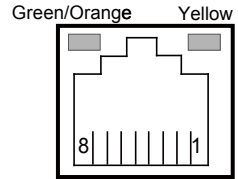

LAN1 / LAN2

LAN2 Pin Assignment:

PIN	ASSIGNMENT
1	LAN2_MDIP0
2	LAN2_MDIN0
3	LAN2_MDIP1
4	LAN2_MDIP2
5	LAN2_MDIN2
6	LAN2_MDIN1
7	LAN2_MDIP3
8	LAN2_MDIN3

LAN1 / LAN2 Status

There are LAN LED indicators on the rear side of the main board. By observing their status, you can know the status of the Ethernet connection.

LAN LED Indicator**Left Side LED**

Green Color On7	10/100Mbps LAN Speed Indicator
Orange Color On8	Giga LAN Speed Indicator
Off	No LAN Switch/HUB connected

Right Side LED

Yellow Color Blinking	LAN Message Active
Off	No LAN Message Active

3.5.6 Dual USB 3.0 Connectors

Connector Location: USB1

Description: Dual USB 3.0 Connectors

USB 3.0 signals:

PIN	ASSIGNMENT	PIN	ASSIGNMENT
A1	VCC5_USB1	A5	USB3_RXN1
A2	USB2_P1_DN	A6	USB3_RXP1
A3	USB2_P1_DP	A7	GND
A4	GND	A8	USB3_TXN1
-	-	A9	USB3_TXP1
B1	VCC5_USB1	B5	USB3_RXN2
B2	USB2_P2_DN	B6	USB3_RXP2
B3	USB2_P2_DP	B7	GND
B4	GND	B8	USB3_TXN2
-	-	B9	USB3_TXP2

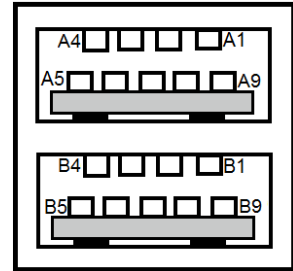

USB1

3.5.7 USB 3.0 Connector

Connector Location: USB2

Description: USB 3.0 Connector

USB 3.0 (USB2) signals:

PIN	ASSIGNMENT	PIN	ASSIGNMENT
1	VCC5_USB2	5	USB3_RXN3
2	USB2_P3_DN	6	USB3_RXP3
3	USB2_P3_DP	7	GND
4	GND	8	USB3_TXN3
-	-	9	USB3_TXP3

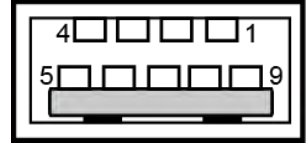

USB2

3.5.8 Digital Input/Output Connector

Connector Location: JDIO1

Description: Digital Input / Output Connector

PIN	ASSIGNMENT	PIN	ASSIGNMENT
1	VCC5	2	GND
3	DIN0	4	DOUT0
5	DIN1	6	DOUT1
7	DIN2	8	DOUT2
9	DIN3	10	DOUT3

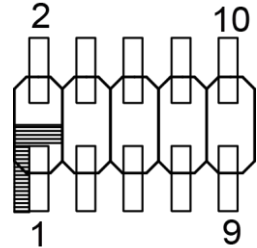

JDIO1

3.5.9 I2C Wafer

Connector Location: JI2C1, JI2C2

Description: I2C Wafer

JI2C1 Pin Assignment:

PIN	ASSIGNMENT
1	GND
2	V3P3S/VCC5
3	I2C4 SCL 33
4	I2C4 SDA 33

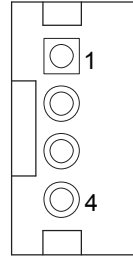

JI2C2 Pin Assignment:

PIN	ASSIGNMENT
1	GND
2	V3P3S/VCC5
3	I2C5 SCL 33
4	I2C5 SDA 33

JI2C1/

JI2C2

3.5.10 I2C PIN2 Voltage Selection

Jumper Location: JP_I2C1

Description: Jumper for selecting PIN2 (V3P3S/VCC5) voltage of JI2C1 and JI2C2.

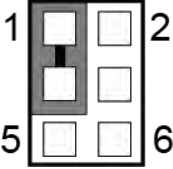
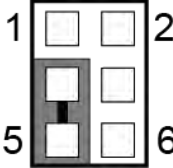
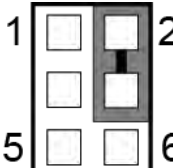
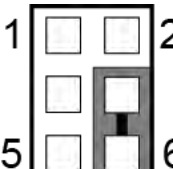
SELECTION	JUMPER SETTING	JUMPER ILLUSTRATION
JI2C1 pin2: 3.3V	1-3 <i>(Default Setting)</i>	 <p>JP_I2C1</p>
JI2C1 pin2: 5V	3-5	 <p>JP_I2C1</p>
JI2C2 pin2: 3.3V	2-4 <i>(Default Setting)</i>	 <p>JP_I2C1</p>
JI2C2 pin2: 5V	4-6	 <p>JP_I2C1</p>

Note 1: Users can change the voltage setting according to the connected I2C device.

Note 2: Please refer to **I2C WAFER** for more details about pin definition of JI2C1 and JI2C2.

3.5.11 DVI Port

Connector Location: DVI1

Description: DVI (Digital Visual Interface) Connector

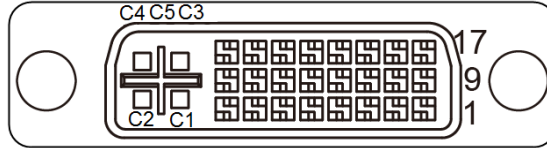

DVI1

PIN	ASSIGNMENT	PIN	ASSIGNMENT
1	DP0_DVI_N2	13	NC
2	DP0_DVI_P2	14	VCC5_DVI
3	GND	15	CRT_CLK
4	NC	16	DP0_DVI_HPD_IN
5	NC	17	DP0_DVI_N0
6	DP0_DVI_SCL	18	DP0_DVI_P0
7	DP0_DVI_SDA	19	GND
8	NC	20	NC
9	DP0_DVI_N1	21	NC
10	DP0_DVI_P1	22	GND
11	GND	23	DP0_DVI_CLKP
12	NC	24	DP0_DVI_CLKN

3.5.12 HDMI Port Connector

Connector Location: HDMI1

Description: DisplayPort Connector

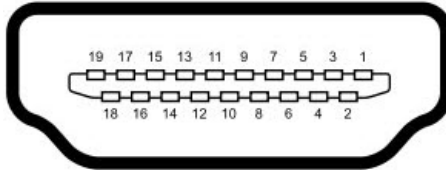

HDMI1

HDMI Connector (HDMI1) signals:

PIN	ASSIGNMENT	PIN	ASSIGNMENT
1	DP1_HDMI_P2	2	GND
3	DP1_HDMI_N2	4	DP1_HDMI_P1
5	GND	6	DP1_HDMI_N1
7	DP1_HDMI_P0-	8	GND
9	DP1_HDMI_N0	10	DP1_HDMI_CLKP
11	GND	12	DP1_HDMI_CLKN
13	NC	14	NC
15	DP1_HDMI_SCL	16	DP1_HDMI_SDA
17	GND	18	VCC5_HDMI
19	DP1_HDMI_HPD_IN	20	-

3.5.13 HD Audio Connector

Connector Location: AUDIO1

Description: HD Audio Connector for Line Out / Mic In.

PIN	ASSIGNMENT
2	HD_MIC1-L
3	HD_GND
1	HD_GND
4	MIC1-JD
5	HD_MIC1-R
22	LINE-OUT-L
23	HD_GND
24	FRONT-JD
25	LINE-OUT-R

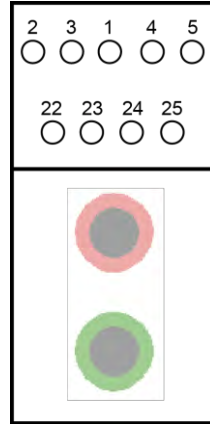

AUDIO1

3.5.14 Low Pin Count (LPC) Connector

Connector Location: JLPC1

Description: Low Pin Count (LPC) Connector

PIN	ASSIGNMENT	PIN	ASSIGNMENT
1	LPC_CLKOUT1	2	GND
3	LPC_LFRAMEJ	4	GND/LPC_SER_IRQ
5	PMU_PLTRST_N	6	LPC_AD0
7	LPC_AD3	8	LPC_AD2
9	V3P3A	10	LPC_AD1

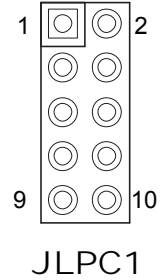

3.5.15 Power over Ethernet (PoE) Connector

Connector Location: JPOE1

Description: Power over Ethernet (PoE) Connector

PIN	ASSIGNMENT	PIN	ASSIGNMENT
1	GND	2	OUT2
3	GND	4	GND
5	POE_DATA	6	GND
7	OUT1	8	GND
9	VOUT_54	10	POE_CLK
11	VOUT_54	12	PoE_POWERIN
13	VOUT_54	14	PoE_POWERIN
15	PoE_POWERIN	16	PoE_POWERIN

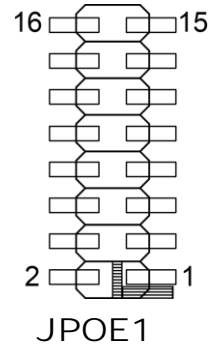

3.5.16 MINI PCI EXPRESS SLOT

Connector Location: M_PCIE1

Description: Mini-PCI Express Slot

PIN	ASSIGNMENT	PIN	ASSIGNMENT
1	PCIE_WAKEJ	2	V3P3A
3	NC	4	GND
5	NC	6	V1P5S_MINI
7	M_CLKREQJ	8	SIM1_PWR
9	GND	10	SIM1_DATA
11	M_PCIE_CLKN	12	SIM1_CLK
13	M_PCIE_CLKP	14	SIM1_RESET
15	GND	16	SIM1_VPP
17	SIM1_SW2	18	GND
19	SIM1_SW1	20	NC
21	GND	22	PMU_PLTRST_N
23	PCIE_P2_RXN	24	V3_3A
25	PCIE_P2_RXP	26	GND
27	GND	28	V1P5S_MINI
29	GND	30	SMB_3P3_SCL
31	PCIE_P2_TXN	32	SMB_3P3_SDA
33	PCIE_P2_TXP	34	GND
35	GND	36	USB2_P7_DN
37	GND	38	USB2_P7_DP
39	V3P3A	40	GND
41	V3P3A	42	NC
43	GND	44	NC
45	NC	46	NC
47	NC	48	VCC1_5
49	NC	50	GND
51	NC	52	V3P3A

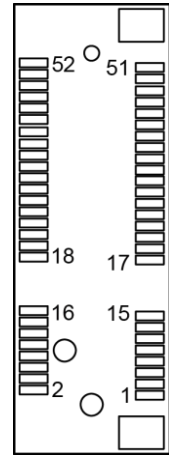

M_PCIE1

Mini PCI Express is the successor of the Mini PCI card and provides an increased data throughput. The cards have a detached network interface and are equipped with one lane. They are used in particular in embedded designs or compact box PCs.

3.5.17 LVDS Connector

Connector Location: LVDS1

Description: LVDS Connector

PIN	ASSIGNMENT	PIN	ASSIGNMENT
1	LVDS_VCC	2	GND
3	LVDS_CLKB_DN	4	LVDS_CLKB_DP
5	GND	6	LVDS_B2_DN
7	LVDS_B2_DP	8	GND
9	LVDS_B1_DN	10	LVDS_B1_DP
11	LVDS_B3_DP	12	LVDS_B3_DN
13	LVDS_B0_DP	14	LVDS_B0_DN
15	GND	16	LVDS_CLKA_DP
17	LVDS_CLKA_DN	18	GND
19	LVDS_A2_DP	20	LVDS_A2_DN
21	GND	22	LVDS_A1_DP
23	LVDS_A1_DN	24	GND
25	LVDS_A0_DP	26	LVDS_A0_DN
27	LVDS_A3_DP	28	LVDS_A3_DN
29	LVDS_VCC	30	LVDS_VCC

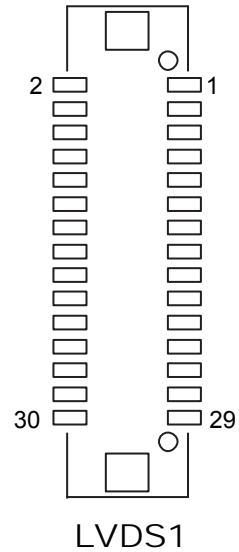

3.5.18 Panel Inverter Connector

Connector Location: JINV1

Description: Panel Inverter Connector

PIN	ASSIGNMENT	PIN	ASSIGNMENT
1	V5P0A	2	V5P0A
3	USB2_P5_DN	4	V12P0_INV
5	USB2_P5_DP	6	V12P0_INV
7	GND	8	V12P0_INV
9	LVDS_BKLTEN	10	V12P0_INV
11	USB2_P6_DN	12	V12P0_INV
13	USB2_P6_DP	14	SATA_LED
15	GND	16	P_LED
17	GND	18	LVDS_BKLCTL
19	VCC5	20	USB2_OC1

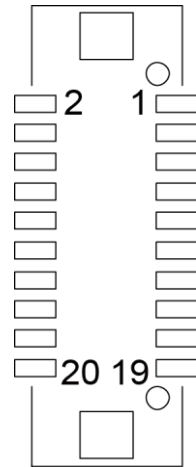

JINV1

3.5.19 Mini-Serial ATA (SATA) SLOT

Connector Location: M_SATA1

Description: Mini-Serial ATA (SATA) Slot

PIN	ASSIGNMENT	PIN	ASSIGNMENT
1	NC	2	V3P3S_MSATA
3	NC	4	GND
5	NC	6	NC
7	NC	8	SIM2_PWR
9	GND	10	SIM2_DATA
11	NC	12	SIM2_CLK
13	NC	14	SIM2_RESET
15	GND	16	SIM2_VPP
17	SIM2_SW2	18	GND
19	SIM2_SW1	20	NC
21	GND	22	NC
23	SATA_RXP1	24	V3P3S_MSATA
25	SATA_RXN1	26	GND
27	GND	28	NC
29	GND	30	NC
31	SATA_TXN1	32	NC
33	SATA_TXP1	34	GND
35	GND	36	USB2_P0_DN
37	GND	38	USB2_P0_DP
39	V3P3S_MSATA	40	GND
41	V3P3S_MSATA	42	NC
43	NC	44	NC
45	NC	46	NC
47	NC	48	NC
49	NC	50	GND
51	NC	52	V3P3S_MSATA

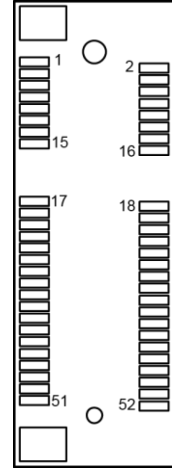

M_SATA1

3.5.20 Serial ATA (SATA) 3.0 Connector

Connector Location: SATA1

Description: Serial ATA (SATA) 3.0 Connector

PIN	ASSIGNMENT
1	GND
2	SATA_TXP0
3	SATA_TXN0
4	GND
5	SATA_RXN0
6	SATA_RXP0
7	GND

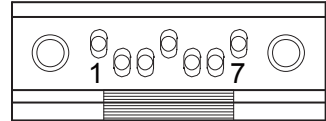

SATA1

3.5.21 HDD Power Connector

Connector Location: SATA_PWR1

Description: HDD Power Connector

PIN	ASSIGNMENT
1	VCC5
2	GND

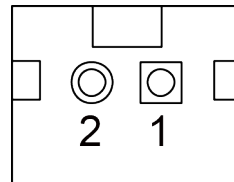

SATA_PWR1

3.5.22 AT / ATX Mode Selection

Jumper Location: JP_ATX1

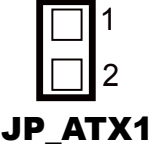
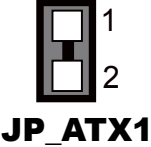

Description: AT / ATX Mode Selection

SELECTION	JUMPER SETTING	JUMPER ILLUSTRATION
ATX	<i>Open (Default Setting)</i>	
AT	1-2	

3.5.23 TPM Module Selection

Jumper Location: JP_TPM1

Description: When you use TPM Module, please put the cap on pins 2-3.

SELECTION	JUMPER SETTING	JUMPER ILLUSTRATION
Normal	<i>1-2 (Default Setting)</i>	
Enable	2-3	



3.5.24 Slide Switch For LVDS Resolution Selection

Jumper Location: SW2

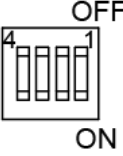
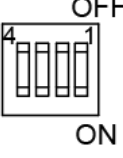
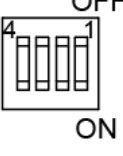
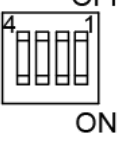
Description: Slide Switch for LVDS Resolution/Channel/Color Bit Selection

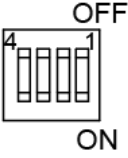
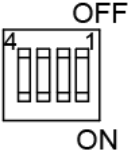
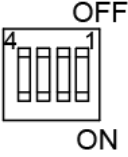
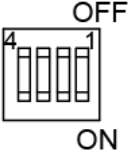
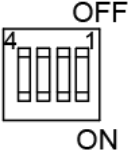
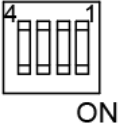
SELECTION	SW2	PIN	SETTING
800 x 600 1CH/18bit <i>(SP-6558/6550</i> <i>Default Setting)</i>		1	ON
		2	ON
		3	ON
		4	ON
1024 x 768 1CH/18bit		1	OFF
		2	ON
		3	ON
		4	ON
1024 x 768 1CH/24bit		1	ON
		2	OFF
		3	ON
		4	ON
1280 x 768 1CH/18bit		1	OFF
		2	OFF
		3	ON
		4	ON
1280 x 800 1CH/18bit		1	ON
		2	ON
		3	OFF
		4	ON

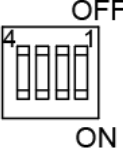
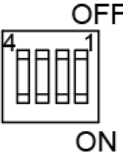
SELECTION	SW2	PIN	SETTING
1280 x 960 1CH/24bit		1	OFF
		2	ON
		3	OFF
		4	ON
1280 x 1024 2CH/24bit		1	ON
		2	OFF
		3	OFF
		4	ON
1366 x 768 1CH/18bit		1	OFF
		2	OFF
		3	OFF
		4	ON
1366 x 768 1CH/24bit		1	ON
		2	ON
		3	ON
		4	OFF
1440 x 900 2CH/24bit		1	OFF
		2	ON
		3	ON
		4	OFF
1400 x 1050 2CH/24bit		1	ON
		2	OFF
		3	ON

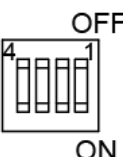
SELECTION	SW2	PIN	SETTING
		4	OFF
1600 x 900 2CH/24bit		1	OFF
		2	OFF
		3	ON
		4	OFF
1680 x 1050 2CH/24bit		1	ON
		2	ON
		3	OFF
		4	OFF
1600 x 1200 2CH/24bit		1	OFF
		2	ON
		3	OFF
		4	OFF
1920 x 1080 2CH/24bit		1	ON
		2	OFF
		3	OFF
		4	OFF
1920 x 1200 2CH/24bit		1	OFF
		2	OFF
		3	OFF
		4	OFF

3.5.25 LVDS Display Selection

Jumper Location: JP_EDP1, JP7

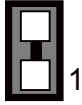

Description: Display selection to LVDS by JP_EDP1 and JP7

SELECTION	JUMPER SETTING	JUMPER ILLUSTRATION
LVDS	2-3 <i>(Default Setting)</i>	 <p>3 1 JP_EDP1</p>
LVDS	1-2 <i>(Default Setting)</i>	 <p>1 JP7</p>

3.5.26 LVDS VCC Voltage Selection

Jumper Location: JP_VDD1

Description: Voltage selection jumper for selecting PIN1, PIN29, PIN30 (LVDS_VCC) voltage of LVDS1.



SELECTION	JUMPER SETTING	JUMPER ILLUSTRATION
3.3V	1-2 <i>(Default Setting)</i>	 <p>JP_VDD1</p>
5V	2-3	 <p>JP_VDD1</p>

Note: Please refer to PANEL INVERTER CONNECTOR for more information about pin definition of JINV1.

3.5.27 LVDS Backlight Control Selection

Jumper Location: JP6

Description: Jumper for selecting PIN18 (LVDS_BKLCTL) voltage of JINV1.

SELECTION	JUMPER SETTING	JUMPER ILLUSTRATION
3.3V	1-2 <i>(Default Setting)</i>	 <p>JP6</p>
5V	2-3	 <p>JP6</p>

Note 1: Users can change the setting according to panel specification

Note 2: Please refer to pin definitions of **PANEL INVERTER CONNECTOR (JINV1)** for more details.

3.5.28 LVDS Panel On/Off Sequence Selection

Jumper Location: JP10

Description: Jumper for selecting PIN18 (LVDS_BKLCTL) voltage of JINV1.

On/Off Sequence by **CPU**.

Set pins 3-5 and 4-6 as connected for controlling LVDS Panel On/Off Sequence by **CH7511**.

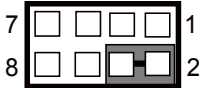
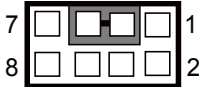
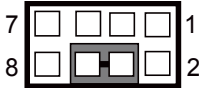
SELECTION	JUMPER SETTING	JUMPER ILLUSTRATION
CPU	<i>1-3 (Default Setting)</i>	 <p>JP10</p>
CPU	<i>2-4 (Default Setting)</i>	 <p>JP10</p>
CH7511	3-5	 <p>JP10</p>
CH7511	4-6	 <p>JP10</p>

3.5.29 LVDS Panel Inverter 12V Soft-Start Time Selection

Jumper Location: JP10

Description: LVDS Panel Inverter 12V Soft-Start Time Selection.

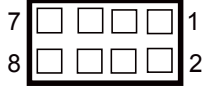
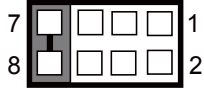
SELECTION	JUMPER SETTING	JUMPER ILLUSTRATION
2ms	Open <i>(Default Setting)</i>	 <p>The diagram shows a 2x4 grid of pins. The top row is labeled '7' on the left and '1' on the right. The bottom row is labeled '8' on the left and '2' on the right. All four pins in both rows are empty, indicating an open jumper setting.</p> <p>JP10</p>
20ms	7-8	 <p>The diagram shows a 2x4 grid of pins. The top row is labeled '7' on the left and '1' on the right. The bottom row is labeled '8' on the left and '2' on the right. A vertical bar connects the two pins in the first column (pins 7 and 8), indicating they are shorted together.</p> <p>JP10</p>



Note: Users can change the setting according to panel specification

3.5.30 CLEAR CMOS DATA SELECTION

Jumper Location: JP4

Description: Clear CMOS Data Selection

- Step1.** Remove the main power of the PC.
- Step2.** Close JP4 (pins 1-2) for 6 seconds by a cap.
- Step3.** Remove the cap which is just used on JP4 (1-2), so that JP4 returns to “OPEN”.
- Step4.** Power on the PC and the PC will then auto-reboot for once in order to set SoC’s register.
- Step5.** Done!

SELECTION	JUMPER SETTING	JUMPER ILLUSTRATION
Normal	Open <i>(Default Setting)</i>	
Clear CMOS*	1-2	

Note: Please make sure the main power is off before clearing CMOS.

3.5.31 MicroSD Card Connector

Connector Location: SDCARD1 (rear side of main board)

Description: MicroSD (Secure Digital) Card Connector

PIN	ASSIGNMENT
1	DAT3
2	CMD
3	GND
4	VDD
5	CLK
6	GND
7	DAT0
8	DAT1
9	DAT2

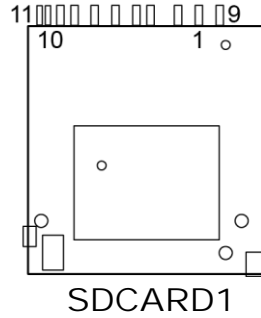

3.5.32 SIM Card Connectors

Connector Location: SIM1, SIM2 (rear side of main board)

Description: SIM (Subscriber Identity Module) Card Connectors

PIN	ASSIGNMENT
C1	VCC
C2	RST
C3	CLK
C5	GND
C6	VPP
C7	DATA



SIM1 / SIM2

3.6 TOUCH CONTROL BOARD SR-6145 CONNECTOR QUICK REFERENCE TABLE

JUMPER Description	NAME
Touch Panel Up Signal Setting	JP1
Touch Panel Low Signal Setting	JP2

CONNECTOR Description	NAME
Control Signal Connector	SGN_BRD1
LVDS Panel Signal Connector (Connected To Motherboard)	LVDS_MB1
LVDS Panel Signal Connector (Connected To LCD Panel)	LVDS_LCD1
15" Panel LED Backlight Control Connector	JLED_DRV
Touch Panel Connector	JTP1
LED1 Connector	JLED1

3.7 TOUCH CONTROL BOARD SR-6145 COMPONENT LOCATIONS

3.7.1 TOUCH CONTROL Board SR-6145 Top View

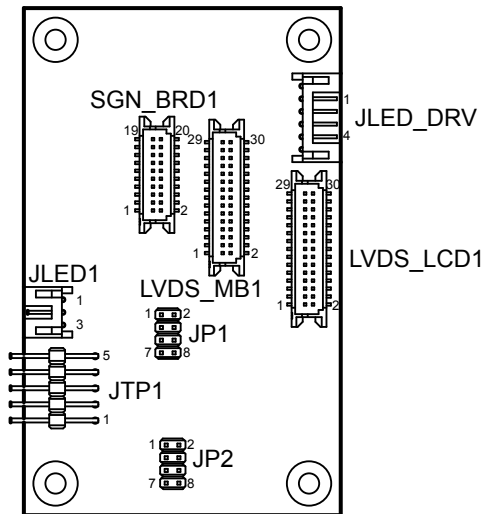

3.8 SETTING TOUCH CONTROL BOARD SR-6145 CONNECTORS AND JUMPERS

3.8.1 Control Signal Connector

Connector Location: SGN_BRD1

Description: Control Signal Connector

PIN	ASSIGNMENT	PIN	ASSIGNMENT
1	5VSB	2	5VSB
3	USB D+	4	+12V
5	USB D-	6	+12V
7	GND	8	+12V
9	Backlight Enable	10	+12V
11	NC	12	+12V
13	NC	14	HD_LED
15	GND	16	POWER_LED
17	GND	18	LCD_PWM
19	VCC	20	USB_OC

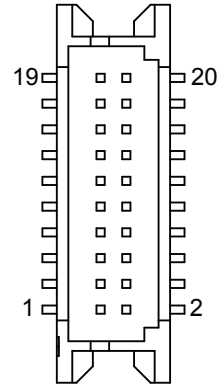

SGN_BRD1

3.8.2 LVDS Panel Signal Connector (Connected To Motherboard)

Connector Location: LVDS_MB1

Description: LVDS Panel Signal Connector

PIN	ASSIGNMENT	PIN	ASSIGNMENT
1	LVDS_VCC	2	GND
3	LVDS1_CLK-(Even)	4	LVDS1_CLK+(Even)
5	GND	6	LVDS1_D2-(Even)
7	LVDS1_D2+(Even)	8	GND
9	LVDS1_D1-(Even)	10	LVDS1_D1+(Even)
11	LVDS1_D3+(Even)	12	LVDS1_D3-(Even)
13	LVDS1_D0+(Even)	14	LVDS1_D0-(Even)
15	GND	16	LVDS0_CLK+(Odd)
17	LVDS0_CLK-(Odd)	18	GND
19	LVDS0_D2+(Odd)	20	LVDS0_D2-(Odd)
21	GND	22	LVDS0_D1+(Odd)
23	LVDS0_D1-(Odd)	24	GND
25	LVDS0_D0+(Odd)	26	LVDS0_D0-(Odd)
27	LVDS0_D3+(Odd)	28	LVDS0_D3-(Odd)
29	LVDS_VCC	30	LVDS_VCC

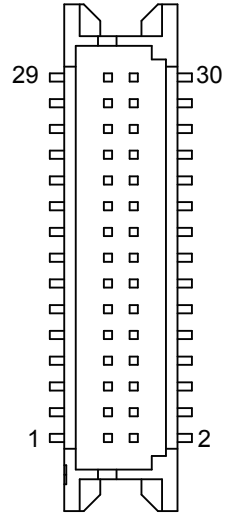

LVDS_MB1

3.8.3 LVDS Panel Signal Connector (Connected To LCD Panel)

Connector Location: LVDS_LCD1

Description: LVDS Panel Signal Connector

PIN	ASSIGNMENT	PIN	ASSIGNMENT
1	LVDS_VCC	2	GND
3	LVDS1_CLK-(Even)	4	LVDS1_CLK+(Even)
5	GND	6	LVDS1_D2-(Even)
7	LVDS1_D2+(Even)	8	GND
9	LVDS1_D1-(Even)	10	LVDS1_D1+(Even)
11	LVDS1_D3+(Even)	12	LVDS1_D3-(Even)
13	LVDS1_D0+(Even)	14	LVDS1_D0-(Even)
15	GND	16	LVDS0_CLK+(Odd)
17	LVDS0_CLK-(Odd)	18	GND
19	LVDS0_D2+(Odd)	20	LVDS0_D2-(Odd)
21	GND	22	LVDS0_D1+(Odd)
23	LVDS0_D1-(Odd)	24	GND
25	LVDS0_D0+(Odd)	26	LVDS0_D0-(Odd)
27	LVDS0_D3+(Odd)	28	LVDS0_D3-(Odd)
29	LVDS_VCC	30	LVDS_VCC

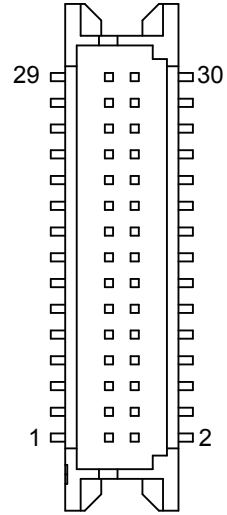

LVDS_LCD1

3.8.4 15" Panel LED Backlight Control Connector

Connector Location: JLED_DRV

Description: 15" Panel LED Backlight Control Connector

PIN	ASSIGNMENT
1	+12V
2	+12V
3	GND
4	LCD_PWM

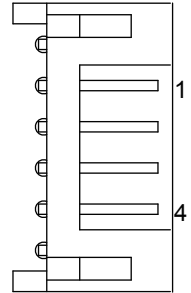

JLED_DRV

3.8.5 Touch Panel Connector

Connector Location: JTP1

Description: Touch Panel Connector

PIN	ASSIGNMENT
1	Low Right or Low Left
2	Low Left or Low Right
3	Sense signal
4	Up Right or Up Left
5	Up Left or Up Right

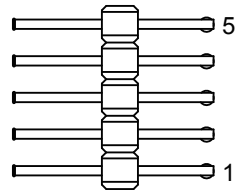

JTP1

3.8.6 LED1 Connector

Connector Location: JLED1

Description: LED1 Connector

PIN	ASSIGNMENT
1	VCC
2	POWER LED
3	HDD LED

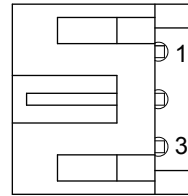

JLED1

3.8.7 Touch Panel Up Signal Setting

Jumper Location: JP1

Description: Touch Panel Up Signal Setting

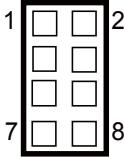
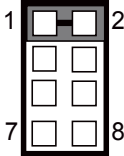
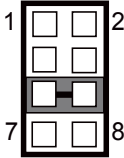
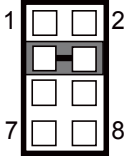
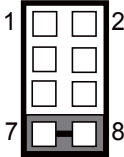
SELECTION	JUMPTER SETTING	JUMPER ILLUSTRATION
Normal	Open <i>(Default Setting)</i>	 <p>JP1</p>
Connect Up Left Signal	1-2	 <p>JP1</p>
Connect Up Right Signal	5-6	 <p>JP1</p>
Connect Up Right Signal	3-4	 <p>JP1</p>
Connect Up Left Signal	7-8	 <p>JP1</p>

3.8.8 Touch Panel Low Signal Setting

Jumper Location: JP2

Description: Touch Panel Low Signal Setting

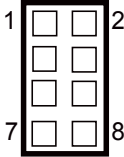
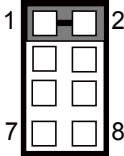
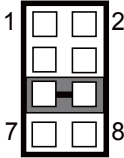
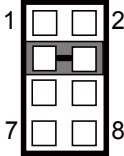
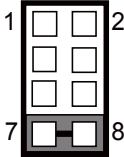
SELECTION	JUMPTER SETTING	JUMPER ILLUSTRATION
Normal	Open <i>(Default Setting)</i>	 <p>JP2</p>
Connect Low Left Signal	1-2	 <p>JP2</p>
Connect Low Right Signal	5-6	 <p>JP2</p>
Connect Low Right Signal	3-4	 <p>JP2</p>
Connect Low Left Signal	7-8	 <p>JP2</p>

4 Software Utilities

This chapter provides the detailed information that guides users to install driver utilities for the system. The following topics are included:

- Installing Intel[®] Chipset Software Installation Utility
- Installing Intel[®] Trusted Execution Engine Installation Utility
- Installing Graphics Driver Utility
- Installing LAN Driver Utility
- Installing Sound Driver Utility
- Installing Intel[®] Serial I/O Driver Utility
- Installing Microsoft Hotfix kb3211320 and kb3213986 Driver Utility

4.1 Introduction

Enclosed with the SP-6558 / 6550 Series package is our driver utilities contained in a DVD-ROM disk. Refer to the following table for driver locations:

SP-6558

Filename (Assume that DVD-ROM drive is D:)	Purpose	OS	
		DOS	Win10/64 bit
D:\SP-6558 V1.0\Driver\Flash BIOS	For Aptio(EFI) BIOS update utility	✓	X
D:\SP-6558 V1.0\Driver\Platform\Main Chip	Intel(R) Chipset Device Software Installation Utility	X	✓
D:\SP-6558 V1.0\Driver\Platform\Graphics	Intel N3350 For VGA Driver installation	X	✓
D:\SP-6558 V1.0\Driver\Platform\Hotfix	Microsoft Hotfix kb3211320 and kb3213986 for Windows10 64-bit critical security update	X	✓
D:\SP-6558 V1.0\Driver\Platform\TXE	For Intel Trusted Execution Engine Interface	X	✓
D:\SP-6558 V1.0\Driver\Platform\LAN Chip	Intel I210AT & I210AT For LAN Driver installation	X	✓
D:\SP-6558 V1.0\Driver\Platform\Sound Codec	Realtek ALC888S For Sound driver installation	X	✓
D:\SP-6558 V1.0\Driver\Platform\Serial IO	Intel(R) Serial IO Driver	X	✓

Note: Install the driver utilities immediately after the OS installation is completed.

X : Not supported

✓ : Supported

SP-6550

Filename (Assume that DVD-ROM drive is D:)	Purpose	OS	
		DOS	Win10/64 bit
D:\SP-6550 V1.0\Driver\Flash BIOS	For Aptio(EFI) BIOS update utility	✓	X
D:\SP-6550 V1.0\Driver\Platform\Main Chip	Intel(R) Chipset Device Software Installation Utility	X	✓
D:\SP-6550 V1.0\Driver\Platform\Graphics	Intel N3350 For VGA Driver installation	X	✓
D:\SP-6550 V1.0\Driver\Platform\Hotfix	Microsoft Hotfix kb3211320 and kb3213986 for Windows10 64-bit critical security update	X	✓
D:\SP-6550 V1.0\Driver\Platform\TXE	For Intel Trusted Execution Engine Interface	X	✓
D:\SP-6550 V1.0\Driver\Platform\LAN Chip	Intel I210AT & I210AT For LAN Driver installation	X	✓
D:\SP-6550 V1.0\Driver\Platform\Sound Codec	Realtek ALC888S For Sound driver installation	X	✓
D:\SP-6550 V1.0\Driver\Platform\Serial IO	Intel(R) Serial I/O Driver	X	✓

Note: Install the driver utilities immediately after the OS installation is completed.

X : Not supported

✓: Supported

4.2 Installing Intel® Chipset Software Installation Utility

4.2.1 Introduction

The Intel® Chipset Software Installation Utility installs the Windows *.INF files to the target system. These files outline to the operating system how to configure the Intel chipset components in order to ensure that the following functions work properly:

- Core PCI and ISAPNP Services
- PCIe Support
- SATA Storage Support
- USB Support
- Identification of Intel® Chipset Components in the Device Manager

4.2.2 Intel® Chipset Software Installation Utility

The utility pack is to be installed only for Windows® 10 series, and it should be installed immediately after the OS installation is finished. Please follow the steps below:

- 1** Connect the USB DVD-ROM device to SP-6558 / SP-6550 and insert the driver disk.
- 2** Enter the **Main Chip** folder where the Chipset driver is located.
- 3** Click the chipset driver installation file for driver installation.
- 4** Follow the on-screen instructions to install the driver.
- 5** Once the installation is completed, shut down the system and restart SP-6558 / SP-6550 for the changes to take effect.

4.3 Installing Intel® Trusted Execution Engine Installation Utility

- 1 Connect the USB DVD-ROM device to SP-6558 / SP-6550 and insert the driver disk.
- 2 Enter the **TXE** folder where the driver is located.
- 3 Click **SetupTXE.exe** file for TXE driver installation.
- 4 Follow the on-screen instructions to complete the installation.
- 5 Once the installation is completed, shut down the system and restart SP-6558 / SP-6550 for the changes to take effect.

4.4 Installing Graphics Driver Utility

The graphics interface embedded in SP-6558 / SP-6550 can support a wide range of display types.

To install the Graphics driver utility, follow the steps below:

- 1 Connect the USB DVD-ROM device to SP-6558 / SP-6550 and insert the driver disk.
- 2 Enter the **Graphics** folder where the driver is located.
- 3 Click the graphics driver installation file for driver installation.
- 4 Follow the on-screen instructions to complete the installation.
- 5 Once the installation is completed, shut down the system and restart SP-6558 / SP-6550 for the changes to take effect.

4.5 Installing LAN Driver Utility

Enhanced with LAN function, SP-6558 / SP-6550 supports various network adapters. To install the LAN Driver, follow the steps below:

- 1** Connect the USB DVD-ROM device to SP-6558/6550 and insert the driver disk.
- 2** Enter the **LAN Chip** folder where the driver is located.
- 3** Click the LAN driver installation file for driver installation.
- 4** Follow the on-screen instructions to complete the installation.
- 5** Once the installation is completed, shut down the system and restart SP-6558 / SP-6550 for the changes to take effect.

For more details on the installation procedure, refer to the README.txt file that you can find on LAN Driver Utility.

4.6 Installing Sound Driver Utility

The sound function enhanced in this system is fully compatible with Windows® 10 series.

To install the Sound Driver, follow the steps below:

- 1** Connect the USB DVD-ROM device to SP-6558 / SP-6550 and insert the driver disk.
- 2** Open the **Sound Codec** folder where the driver is located.
- 3** Click the Sound driver installation file for driver installation.
- 4** Follow the on-screen instructions to complete the installation.
- 5** Once the installation is completed, shut down the system and restart SP-6558 / SP-6550 for the changes to take effect.

4.7 Installing Intel® Serial I/O Driver Utility

To install the Serial I/O Driver, follow the steps below:

- 1 Connect the USB DVD-ROM device to SP-6558 / SP-6550 and insert the driver disk.
- 2 Open the **Serial IO** folder where the driver is located.
- 3 Click the **SetupSerialIO.exe** file for driver installation.
- 4 Follow the on-screen instructions to complete the installation.
- 5 Once the installation is completed, shut down the system and restart SP-6558 / SP-6550 for the changes to take effect.

4.8 Installing Microsoft Hotfix kb3211320 and kb3213986 Driver Utility

To install the Hotfix driver utility, follow the steps below:

- 1 Connect the USB DVD-ROM device to SP-6558 / SP-6550 and insert the driver disk.
- 2 Enter the **Hotfix** folder where the driver is located.
- 3 Click the **windows10.0-kb3211320-x64** and **windows10.0-kb3213986-x64** files for critical security update.
- 4 Follow the on-screen instructions to complete the installation.

Once the installation is completed, shut down the system and restart SP-6558 / SP-6550 for the changes to take effect.

5

BIOS SETUP

This chapter guides users how to configure the basic system configurations via the BIOS Setup Utilities. The information of the system configuration is saved in BIOS NVRAM so that the Setup information is retained when the system is powered off. The BIOS Setup Utilities consist of the following menu items:

- Accessing Setup Utilities
- Main Menu
- Advanced Menu
- Chipset Menu
- Security Menu
- Boot Menu
- Save & Exit Menu

5.1 Introduction

The SP-6558/6550 System uses an AMI (American Megatrends Incorporated) Aptio BIOS that is stored in the Serial Peripheral Interface Flash Memory (SPI Flash) and can be updated. The SPI Flash contains the built-in BIOS setup program, Power-On Self-Test (POST), PCI auto-configuration utility, LAN EEPROM information, and Plug and Play support.

Aptio is AMI's BIOS firmware based on the UEFI (Unified Extensible Firmware Interface) specifications and the Intel Platform Innovation Framework for EFI. The UEFI specification defines an interface between the operating system and platform firmware. The interface consists of data tables that contain platform-related information, boot service calls, and runtime service calls that are available to the operating system and its loader. These elements have combined to provide a standard environment for booting the operating system and running pre-boot applications.

The diagram below shows the Extensible Firmware Interface's location in the software stack.

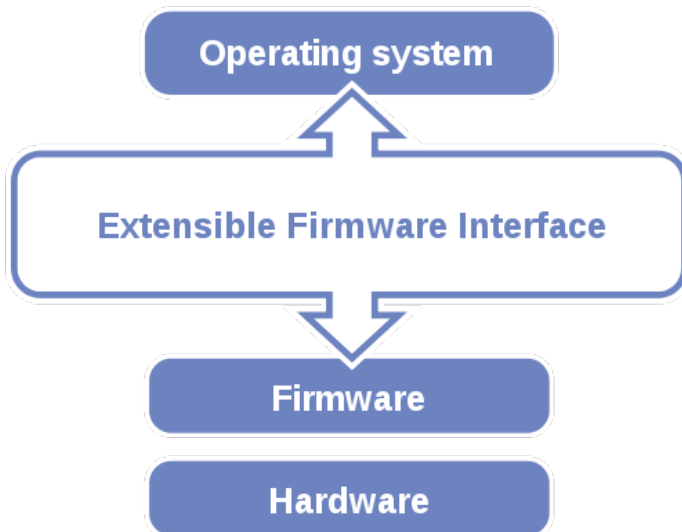

Figure 5-1. Extensible Firmware Interface Diagram

EFI BIOS provides an user interface that allows you to modify hardware configuration, e.g. change the system date and time, enable/disable a system component, determine bootable device priority, set up personal password, etc., which is convenient for engineers to perform modifications and customize the computer system and allows technicians to troubleshoot the occurred errors when the hardware is faulty.

The BIOS setup menu allows users to view and modify the BIOS settings for the computer. After the system is powered on, users can access the BIOS setup menu by pressing or <Esc> immediately while the POST message is running before the operating system is loading.

All the menu settings are described in details in this chapter.

5.2 Accessing Setup Utility

After the system is powered on, BIOS will enter the Power-On Self-Test (POST) routines and the POST message will be displayed:



Figure 5-2. POST Screen with AMI Logo

Press **** or **<Esc>** to access the Setup Utility program and the **Main** menu of the Aptio Setup Utility will appear on the screen as below:

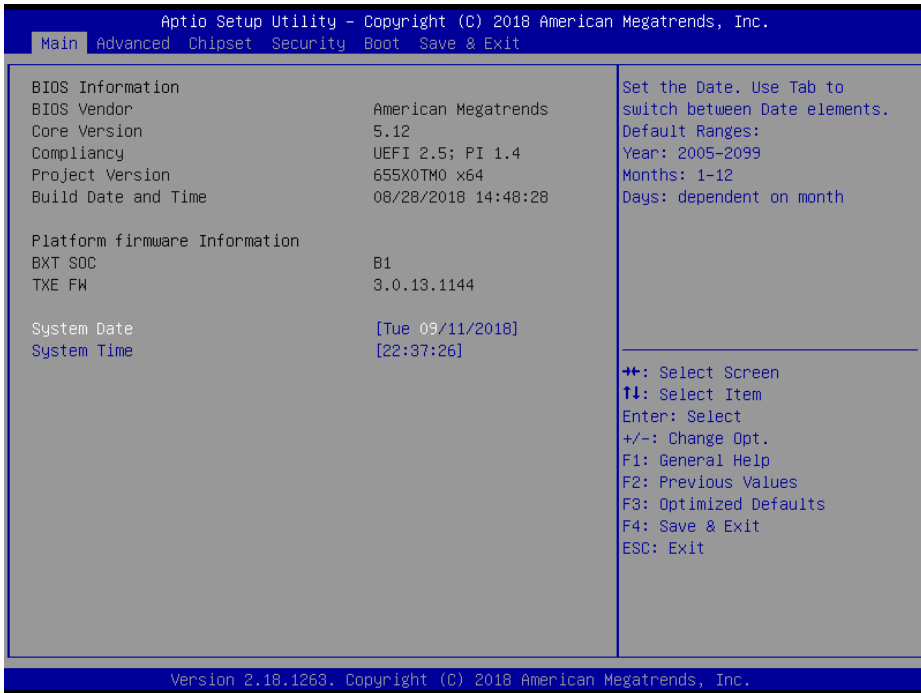

BIOS Setup Menu Initialization Screen

You may move the cursor by <↑> and <↓> keys to highlight the individual menu items. As you highlight each item, a brief description of the highlighted selection will appear on the right side of the screen.

The language of the BIOS setup menu interface and help messages are shown in US English. You may use <↑> or <↓> key to select among the items and press <Enter> to confirm and enter the sub-menu. The following table provides the list of the navigation keys that you can use while operating the BIOS setup menu.

BIOS Setup Navigation Key	Description
<←> and <→>	Select a different menu screen (move the cursor from the selected menu to the left or right).
<↑> and <↓>	Select a different item (move the cursor from the selected item upwards or downwards)
<Enter>	Execute the command or select the sub-menu.
<F2>	Load the previous configuration values.
<F3>	Load the default configuration values.
<F4>	Save the current values and exit the BIOS setup menu.
<Esc>	Close the sub-menu. Trigger the confirmation to exit BIOS setup menu.

5.3 Main

Menu Path *Main*

The **Main** menu allows you to view the BIOS Information, change the system date and time, and view the user access privilege level. Use tab to switch between date elements. Use <↑> or <↓> arrow keys to highlight the item and enter the value you want in each item. This screen also displays the BIOS version (project) and BIOS Build Date and Time.

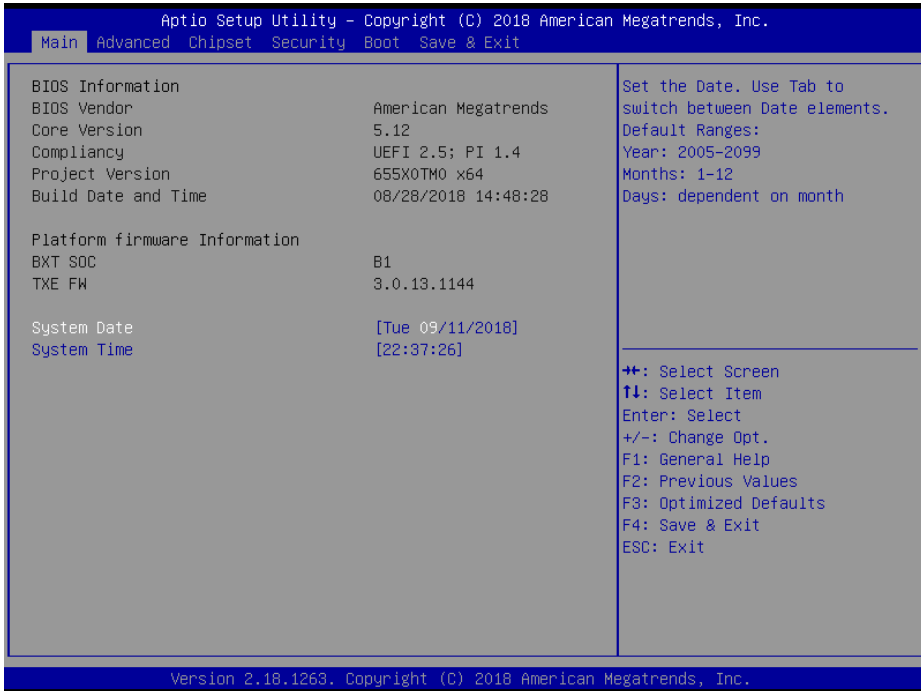

Main Screen

BIOS Setting	Options	Description/Purpose
BIOS Vendor	No changeable options	Displays the name of the BIOS vendor.
Core Version	No changeable options	Displays the current BIOS core version.
Compliancy	No changeable options	Displays the current UEFI version.
Project Version	No changeable options	Displays the version of the BIOS currently installed on the platform.
Build Date and Time	No changeable options	Displays the date that the current BIOS version is built.
BXT SOC	No changeable options	Displays the SoC stepping.
TXE FW	No changeable options	Displays the current TXE firmware version.

BIOS Setting	Options	Description/Purpose
System Date	month, day, year	Sets the system date. The format is [Day Month/ Date/ Year]. Users can directly enter values or use <+> or <-> arrow keys to increase/decrease it. The “Day” is automatically changed.
System Time	hour, minute, second	Sets the system time. The format is [Hour: Minute: Second]. Users can directly enter values or use <+> or <-> arrow keys to increase/decrease it.

5.4 Advanced

Menu Path *Advanced*

This menu provides advanced configurations such as ACPI Settings, Hardware Monitor, F81946 Watchdog, CPU Configuration, F81946 Super I/O Configuration, Network Stack Configuration, USB Configuration and Platform Trust Technology.

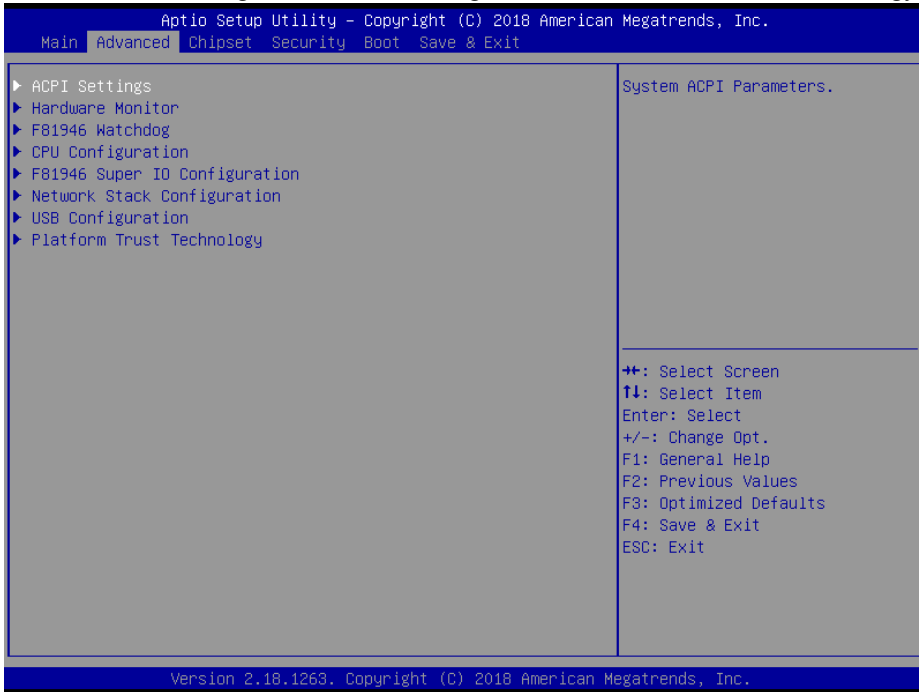

Advanced Menu Screen

BIOS Setting	Options	Description/Purpose
ACPI Settings	Sub-Menu	System ACPI Parameters.
Hardware Monitor	Sub-Menu	Monitor hardware status.
F81946 Watchdog	Sub-Menu	F81946 Watchdog Parameters.
CPU Configuration	Sub-Menu	CPU Configuration Parameters.
F81946 Super IO Configuration	Sub-Menu	F81946 Super I/O Chip Parameters.
Network Stack Configuration	Sub-Menu	Network Stack Settings
USB Configuration	Sub-Menu	USB Configuration Parameters.
Platform Trust Technology	Sub-Menu	Platform Trust Technology

5.4.1 Advanced – ACPI Settings

Menu Path *Advanced > ACPI Settings*

The **ACPI Settings** allows users to configure relevant ACPI (Advanced Configuration and Power Management Interface) settings, such as Enable Hibernation and ACPI Sleep State.



ACPI Settings Screen

BIOS Setting	Options	Description/Purpose
Enable Hibernation	- Disabled - Enabled	Enables or Disables System ability to Hibernate (OS/S4 Sleep State). This option may be not effective with some OS.
ACPI Sleep State	- Suspend Disabled - S3 (Suspend to RAM)	Selects the ACPI sleep state the system will enter when the SUSPEND button is pressed. If S3 (Suspend to RAM) is selected, the system shuts down with the exception of a refresh current to the memory.

5.4.2 Advanced – Hardware Monitor

Menu Path *Advanced > Hardware Monitor*

The **Hardware Monitor** allows users to monitor the health and status of the system such as CPU temperature, system temperature and voltage levels in supply.

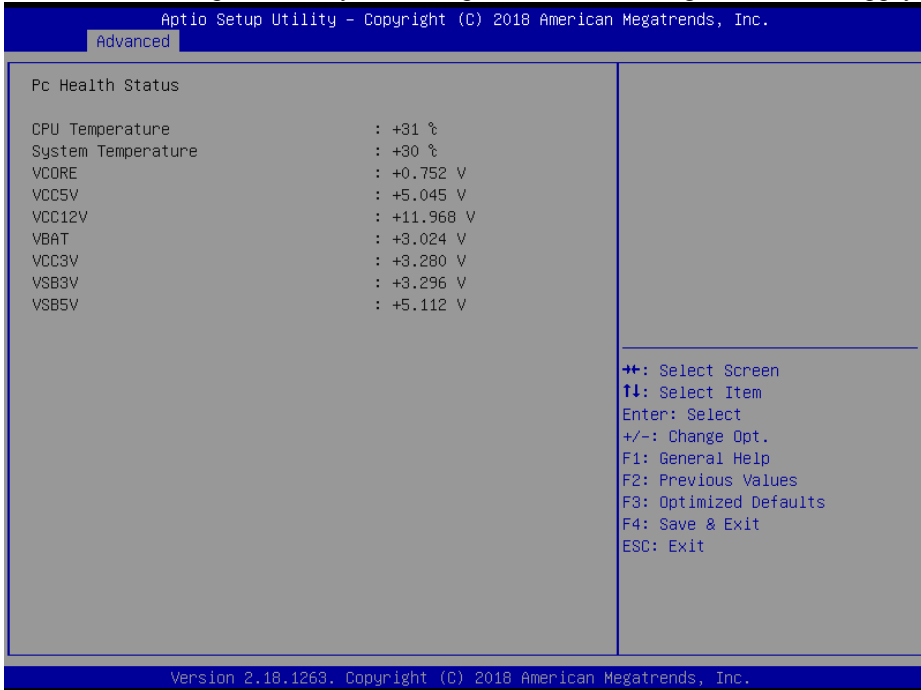

Hardware Monitor Screen

BIOS Setting	Options	Description/Purpose
CPU Temperature	No changeable options	Displays the processor's temperature.
System Temperature	No changeable options	Displays the system's temperature.
VCORE	No changeable options	Detects and displays the VCORE CPU voltage.
VCC5V	No changeable options	Detects and displays 5V voltage.
VCC12V	No changeable options	Detects and displays 12V voltage.
VBAT	No changeable options	Detects and displays the battery voltage.
VCC3V	No changeable options	Detects and displays 3V voltage.
VS3V	No changeable options	Detects and displays VS3V voltage.
VS5V	No changeable options	Detects and displays VS5V voltage.

5.4.3 Advanced – F81946 Watchdog Configuration

Menu Path *Advanced > F81946 Watchdog*

If the system hangs or fails to respond, enable the F81946 watchdog function to trigger a system reset via the 255-level watchdog timer.

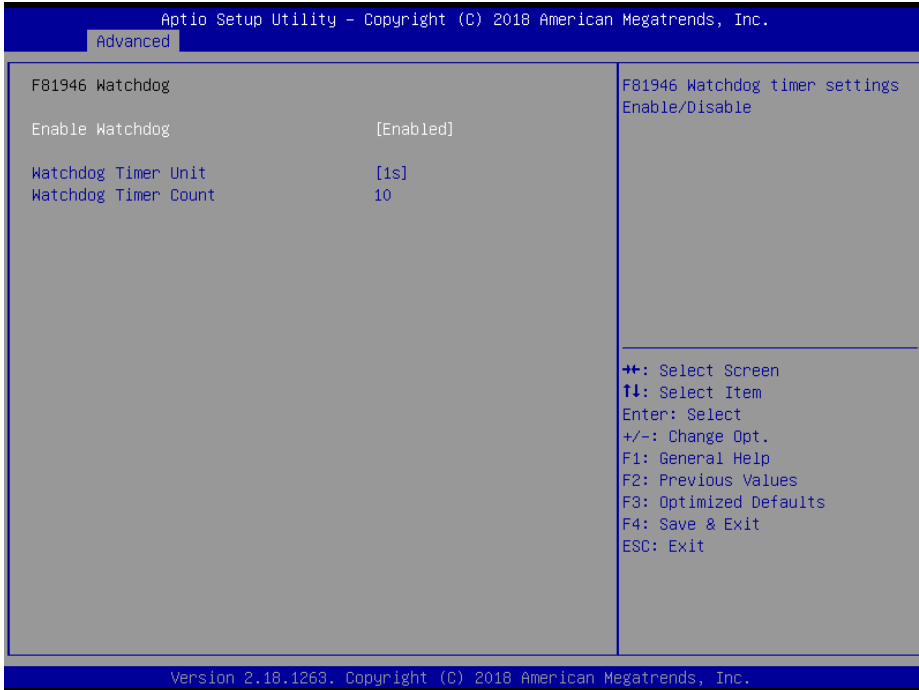

F81946 Watchdog Configuration Screen

BIOS Setting	Options	Description/Purpose
Enable Watchdog	- Enabled - Disabled	Enables/Disables F81946 Watchdog timer settings.
Watchdog Timer Unit	- 1s - 60s	Selects 1s (second) or 60s (minute) as the time unit of Watchdog timer.
Watchdog Timer Count	Numeric (from 1 to 255)	Sets the timeout for Watchdog timer. (Max. value: 255 seconds or minutes) 1s unit: 10-59, 60s unit: 1-255 Watchdog Timer = Unit * Count.

5.4.4 Advanced – CPU Configuration

Menu Path *Advanced > CPU Configuration*

The **CPU Configuration** provides advanced CPU settings and some information about CPU.

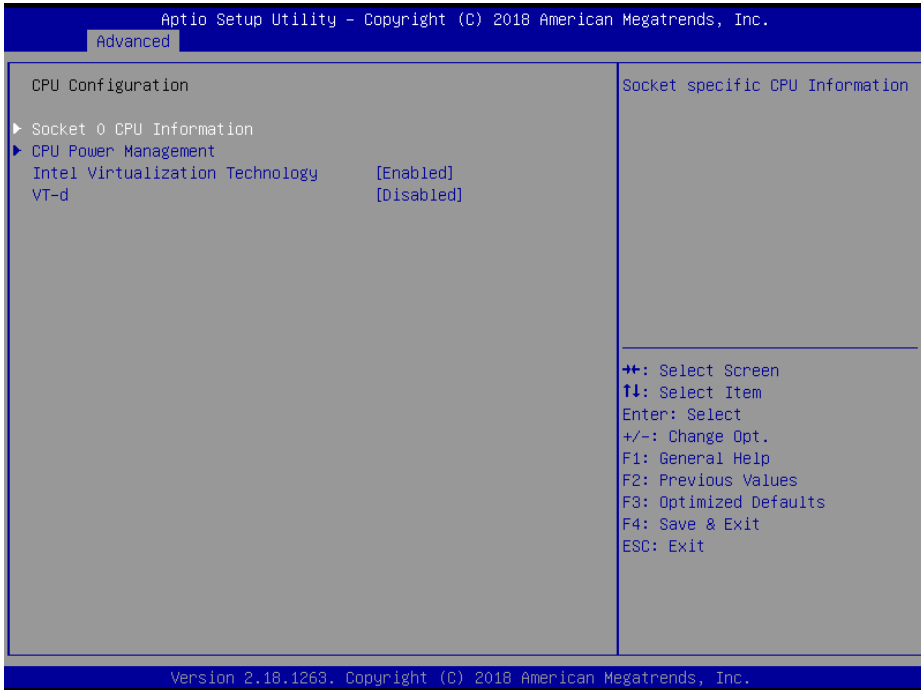

CPU Configuration Screen

BIOS Setting	Options	Description/Purpose
Socket 0 CPU Information	Sub-Menu	Socket specific CPU Information.
CPU Power Management	Sub-Menu	CPU Power Management options.
Intel Virtualization Technology	- Disabled - Enabled	When enabled, a VMM (Virtual Machine Monitor) can utilize the additional hardware capabilities provided by Vanderpool Technology. Previously codenamed "Vanderpool", VT-x represents Intel's technology for virtualization on the x86 platform.
VT-d	- Disabled - Enabled	Enables or Disables VT-d settings.

Menu Path *Advanced > CPU Configuration > Socket 0 CPU Information*

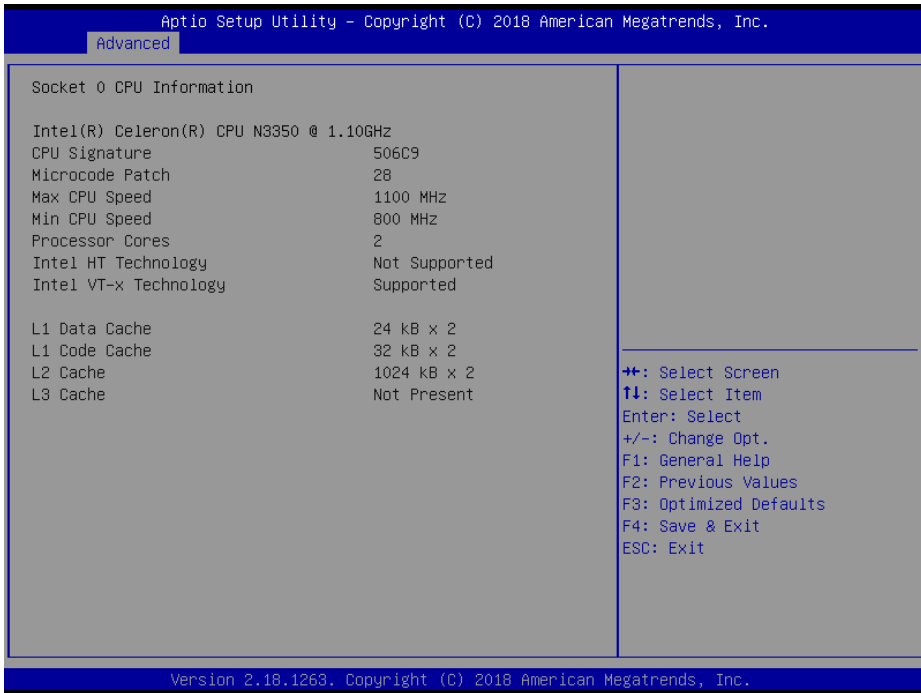

Socket 0 CPU Information Screen

BIOS Setting	Options	Description/Purpose
CPU Signature	No changeable options	Displays CPU signature information.
Microcode Patch	No changeable options	Displays CPU Microcode Patch Revision.
Max CPU Speed	No changeable options	Displays the maximum CPU speed.
Min CPU Speed	No changeable options	Displays the minimum CPU speed.
Processor Cores	No changeable options	Displays the number of cores of the processor.
Intel HT Technology	No changeable options	Reports if Intel Hyper-Threading Technology is supported by the processor.
Intel VT-x Technology	No changeable options	Reports if Intel VT-x Technology is supported by the processor. Previously codenamed "Vanderpool", VT-x represents Intel's technology for virtualization on the x86 platform. Utilizing Vanderpool Technology

BIOS Setting	Options	Description/Purpose
		(VT), a VMM (Virtual Machine Monitor) can utilize the additional hardware capabilities.
L1 Data Cache	No changeable options	Displays L1 Data Cache Size
L1 Code Cache	No changeable options	Displays L1 Code Cache Size
L2 Cache	No changeable options	Displays L2 Cache Size
L3 Cache	No changeable options	Displays L3 Cache Size

Menu Path *Advanced > CPU Configuration > CPU Power Management*

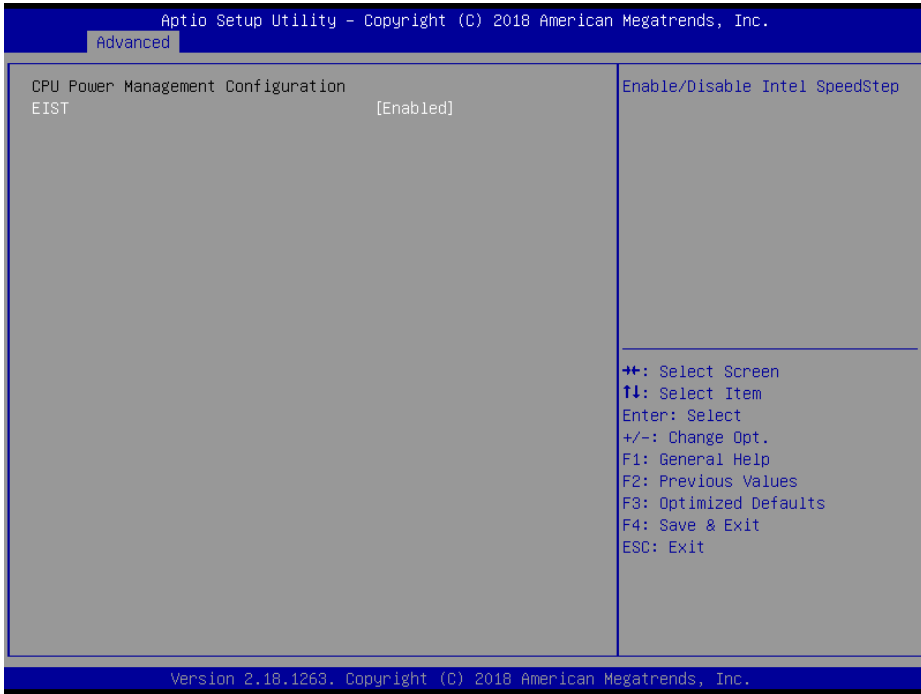

CPU Power Management Screen

BIOS Setting	Options	Description/Purpose
EIST	- Disabled - Enabled	Enables or Disables Intel SpeedStep.

5.4.5 Advanced – F81946 Super I/O Configuration

Menu Path *Advanced > F81946 Super IO Configuration*

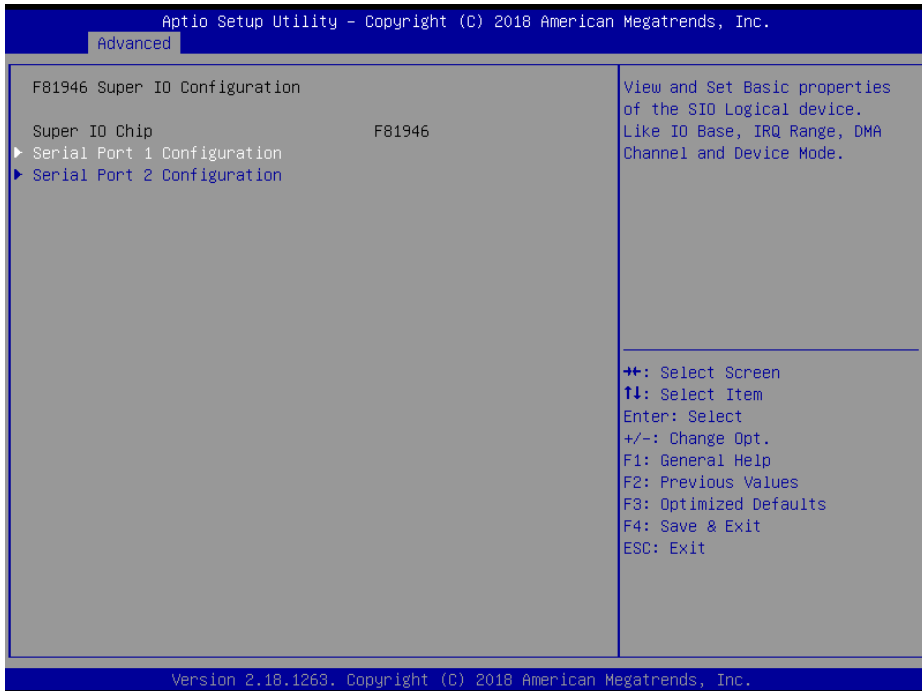

F81946 Super I/O Configuration Screen

BIOS Setting	Options	Description/Purpose
Serial Port 1 Configuration	Sub-Menu	Sets the parameters of Serial Port 1 (COMA).
Serial Port 2 Configuration	Sub-Menu	Sets the parameters of Serial Port 2 (COMB).

Menu Path *Advanced > F81946 Super IO Configuration > Serial Port 1 Configuration*

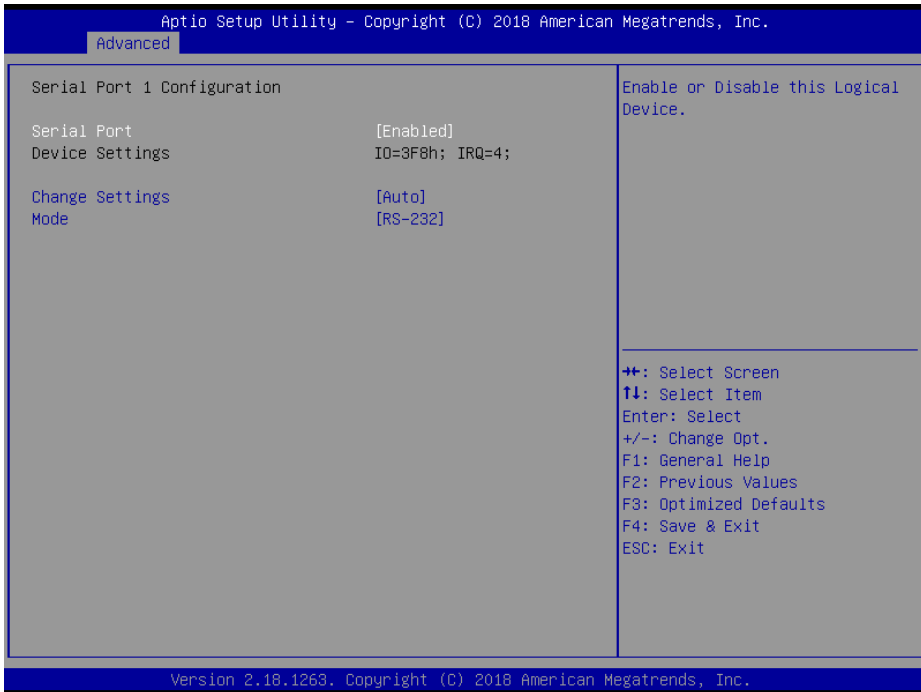

Serial Port 1 Configuration Screen

BIOS Setting	Options	Description/Purpose
Serial Port	- Disabled - Enabled	Enables or Disables Serial Port 1.
Device settings	No changeable options	Displays the current settings of Serial Port 1.
Change Settings	- Auto - IO=3F8h; IRQ=4; - IO=3F8h; IRQ=3,4,5,6,7,10,11; - IO=2F8h; IRQ=3,4,5,6,7,10,11; - IO=3E8h; IRQ=3,4,5,6,7,10,11; - IO=2E8h; IRQ=3,4,5,6,7,10,11;	Allows users to select specific IO address and IRQ for Serial Port 1.
Mode	- RS-232 - RS-422 - RS-485	Selects COM mode.

Menu Path *Advanced > F81946 Super IO Configuration > Serial Port 2 Configuration*

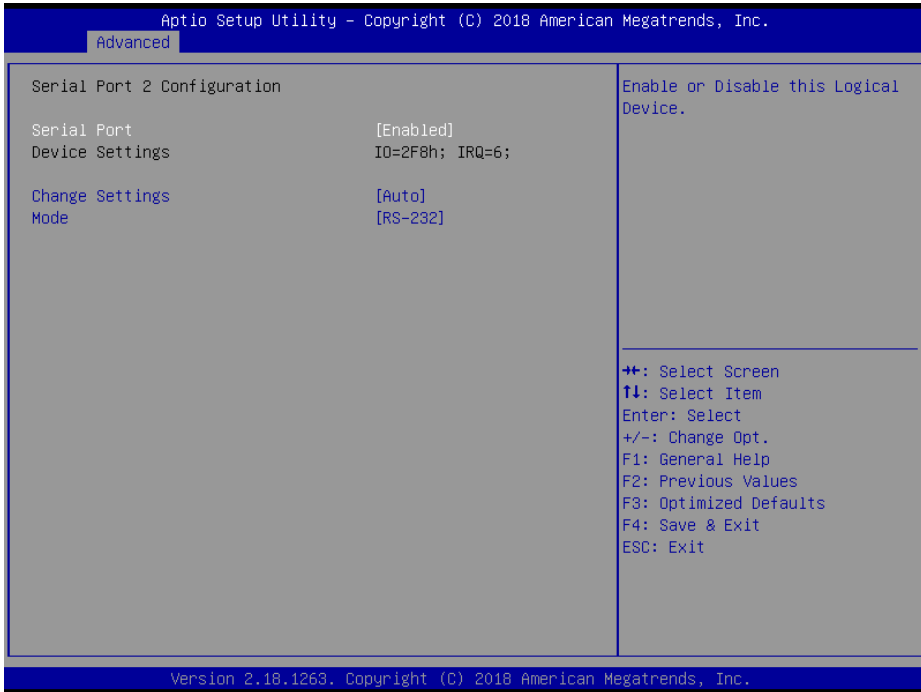

Serial Port 2 Configuration Screen

BIOS Setting	Options	Description/Purpose
Serial Port	- Disabled - Enabled	Enables or Disables Serial Port 2.
Device Settings	No changeable options	Displays the current settings of Serial Port 2.
Change Settings	- Auto - IO=2F8h; IRQ=6; - IO=3F8h; IRQ=3,4,5,6,7,10,11; - IO=2F8h; IRQ=3,4,5,6,7,10,11; - IO=3E8h; IRQ=3,4,5,6,7,10,11; - IO=2E8h; IRQ=3,4,5,6,7,10,11;	Allows you to select specific IO address and IRQ for Serial Port 2.
Mode	- RS-232 - RS-422 - RS-485	Selects COM mode.

5.4.6 Advanced – Network Stack Configuration

Menu Path *Advanced > Network Stack Configuration*

The **Network Stack Configuration** allows users to enable/disable UEFI Network Stack, IPv4/IPv6 PXE (Pre-Boot Execution) support and configure PXE boot wait time and detect the media presence.

PXE allows a workstation to boot from a server on a network prior to booting the operating system on the local hard drive. A PXE-enabled workstation connects its NIC to the LAN via a jumper, which keeps the workstation connected to the network even when the power is turned off.



Network Stack Configuration Screen

BIOS Setting	Options	Description/Purpose
Network Stack	- Disabled - Enabled	Enables or Disables UEFI Network Stack.
Ipv4 PXE Support	- Disabled - Enabled	Enables IPv4 PXE Boot Support. If disabled, IPv4 PXE boot option will not be created.
Ipv6 PXE Support	- Disabled - Enabled	Enables IPv6 PXE Boot Support. If disabled, IPv6 PXE boot option will not be created.
PXE boot wait time	Numeric (from 0 to 5)	Number of seconds to wait for PXE boot to abort after the Esc key is pressed.

BIOS Setting	Options	Description/Purpose
Media detect count	Numeric (from 1 to 50)	Number of times that the media presence will be checked.

5.4.7 Advanced – USB Configuration

Menu Path *Advanced > USB Configuration*

The **USB Configuration** allows users to configure advanced USB settings such as USB mass storage driver support.

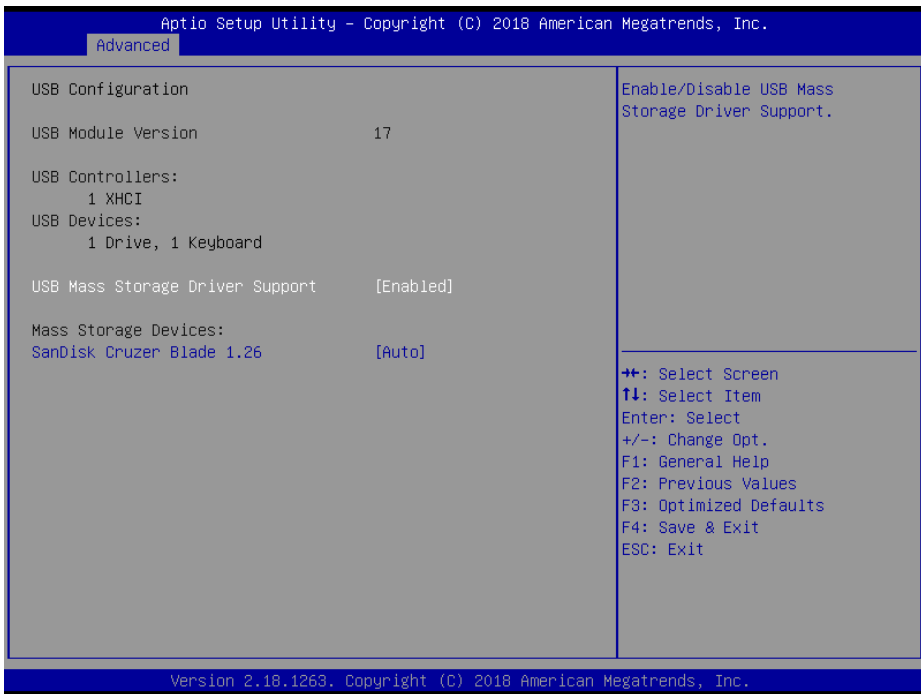

USB Configuration Screen

BIOS Setting	Options	Description/Purpose
USB Mass Storage Driver Support	- Disabled - Enabled	Enables or Disables USB Mass Storage Driver Support.

5.4.8 Advanced - Platform Trust Technology

Menu Path *Advanced > Platform Trust Technology*

The **Platform Trust Technology** allows users to configure advanced TPM settings such as fTPM.

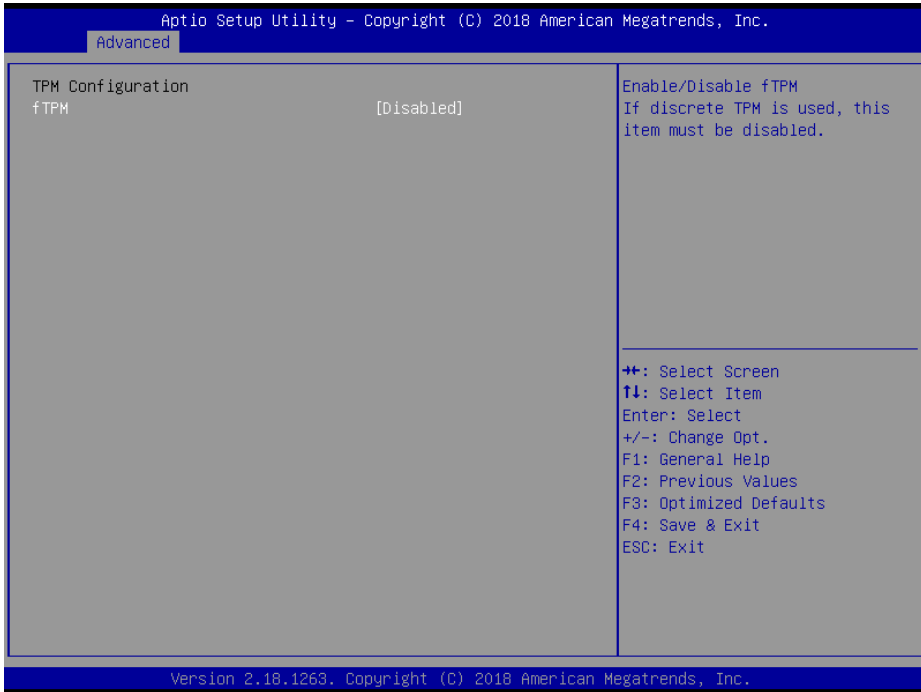

Platform Trust Technology Screen

BIOS Setting	Options	Description/Purpose
fTPM	- Disabled - Enabled	Enables or Disables fTPM. This option must be disabled when discrete TPM is used.

5.5 Chipset

Menu Path *Chipset*

This menu allows users to configure advanced Chipset settings such as North Bridge and South Bridge configuration parameters.

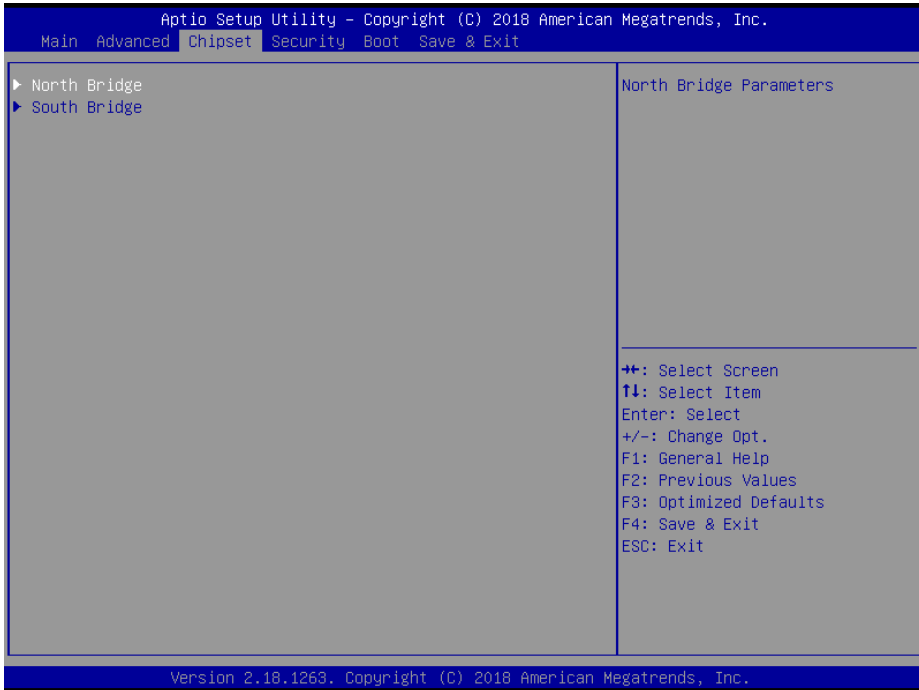

Chipset Screen

BIOS Setting	Options	Description/Purpose
North Bridge	Sub-Menu	North Bridge Parameters.
South Bridge	Sub-Menu	South Bridge Parameters.

5.5.1 Chipset – North Bridge

Menu Path *Chipset > North Bridge*

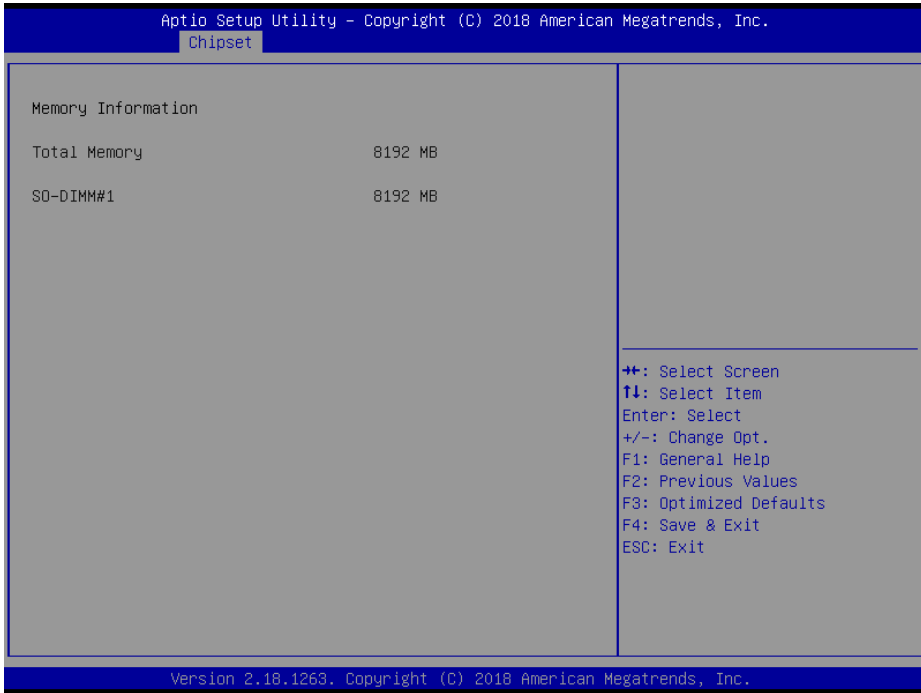

North Bridge Screen

BIOS Setting	Options	Description/Purpose
Total Memory	No changeable options	Displays the total memory on the system.
SO-DIMM#1	No changeable options	Displays the current size of SO-DIMM#1 on the system.

5.5.2 Chipset – South Bridge

Menu Path *Chipset > South Bridge*

The **South Bridge** allows users to configure computer's I/O functions.

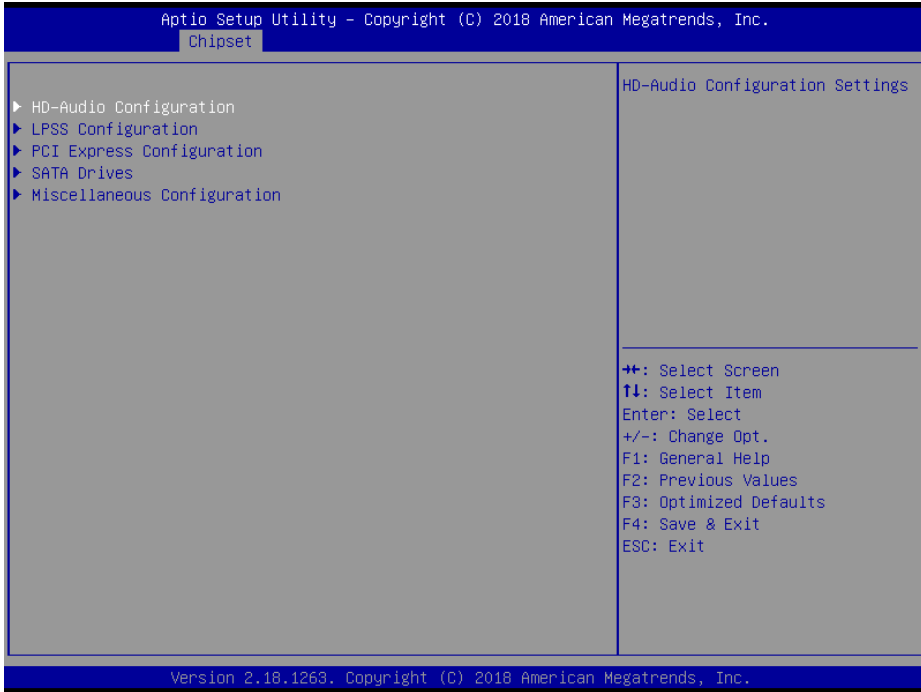

South Bridge Screen

BIOS Setting	Options	Description/Purpose
HD-Audio Configuration	Sub-Menu	HD-Audio Configuration Settings
LPSS Configuration	Sub-Menu	LPSS Configuration Settings.
PCI Express Configuration	Sub-Menu	PCI Express Configuration Settings.
SATA Drives	Sub-Menu	SATA Device Configuration Settings.
Miscellaneous Configuration	Sub-Menu	Miscellaneous Configuration Settings.

Menu Path *Chipset > South Bridge > HD-Audio Configuration*

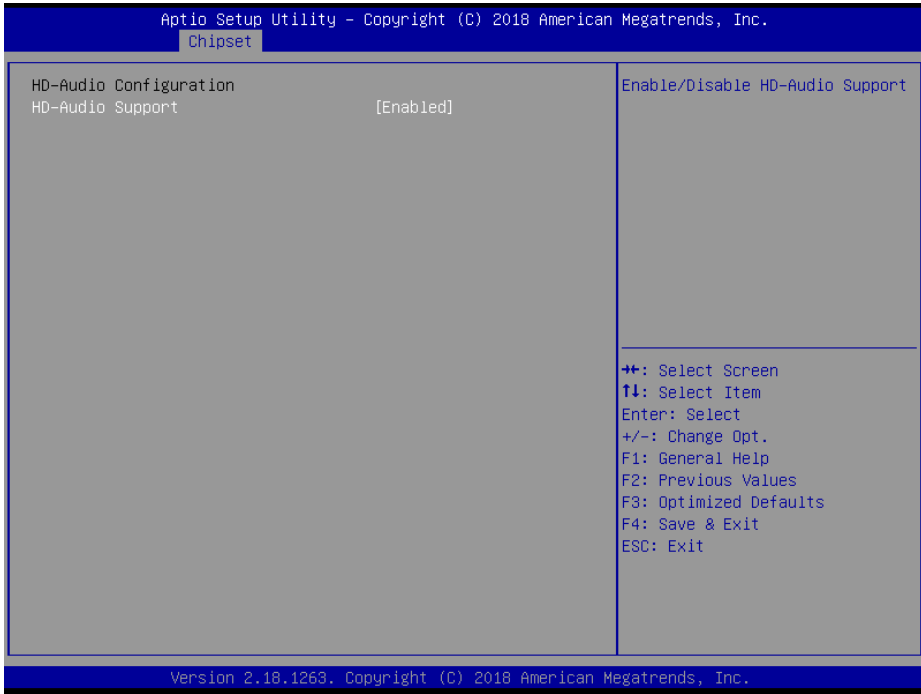

HD-Audio Configuration Screen

BIOS Setting	Options	Description/Purpose
HD-Audio Support	- Disabled - Enabled	Enables or Disables HD-Audio support.

Menu Path *Chipset > South Bridge > LPSS Configuration*

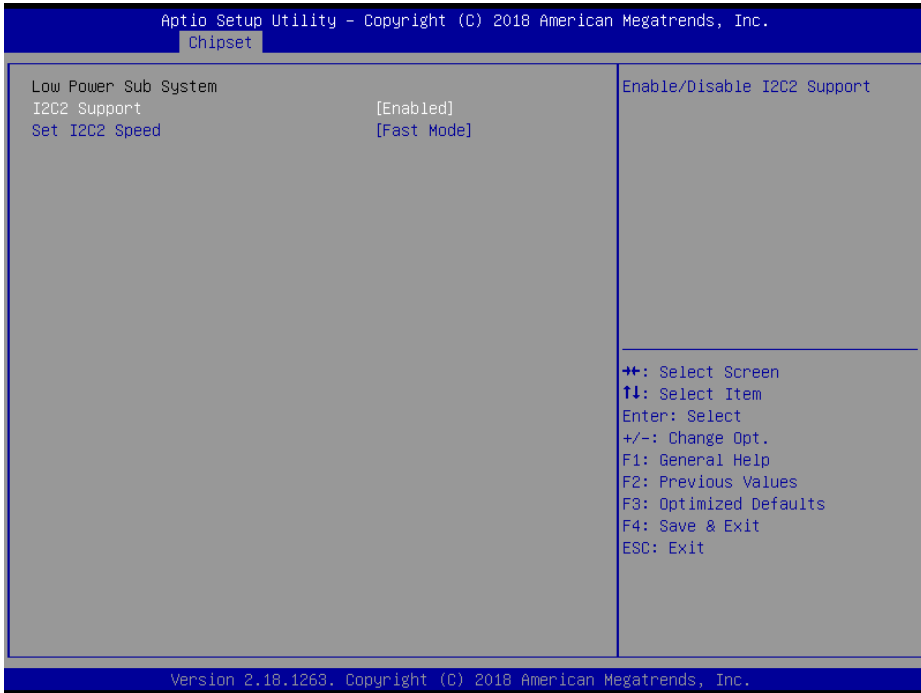

LPSS Configuration Screen

BIOS Setting	Options	Description/Purpose
I2C2 Support	- Disabled - Enabled	Enables or Disables I2C2 Support.
Set I2C2 Speed	- Standard Mode - Fast Mode - Fast Plus Mode - High Speed Mode	Selects I2C2 Speed.

Menu Path *Chipset > South Bridge > PCI Express Configuration*

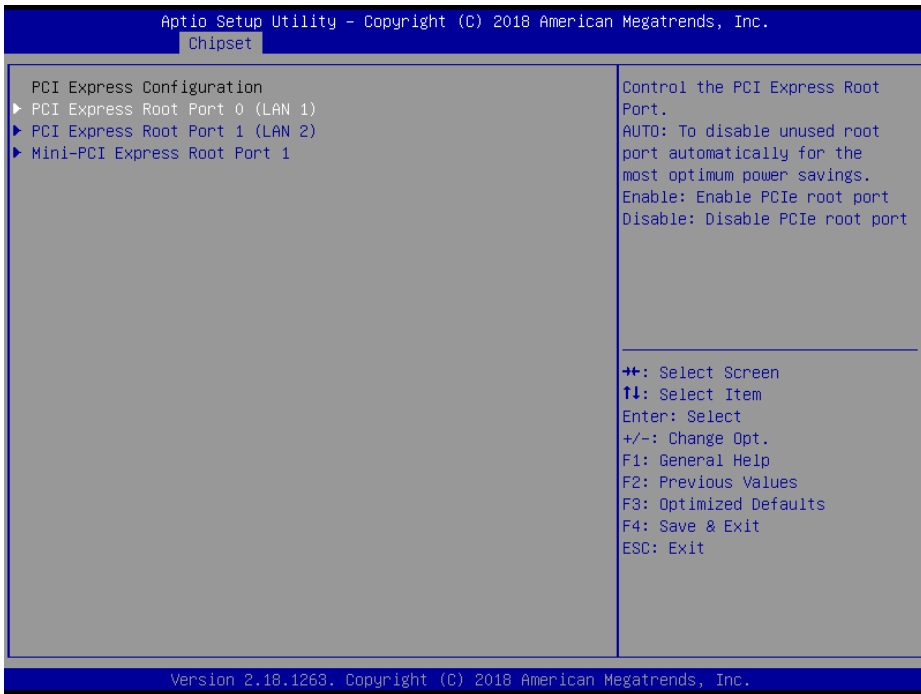

PCI Express Configuration Screen

BIOS Setting	Options	Description/Purpose
PCI Express Root Port 0 (LAN 1)	Sub-Menu	PCI Express Root Port 0 (LAN 1) parameters.
PCI Express Root Port 1 (LAN 2)	Sub-Menu	PCI Express Root Port 1 (LAN 2) parameters.
Mini-PCI Express Root Port 1	Sub-Menu	Mini PCI Express Root Port 1 parameters.

Menu Path *Chipset > South Bridge > PCI Express Configuration > PCI Express Root Port 0 (LAN 1)*

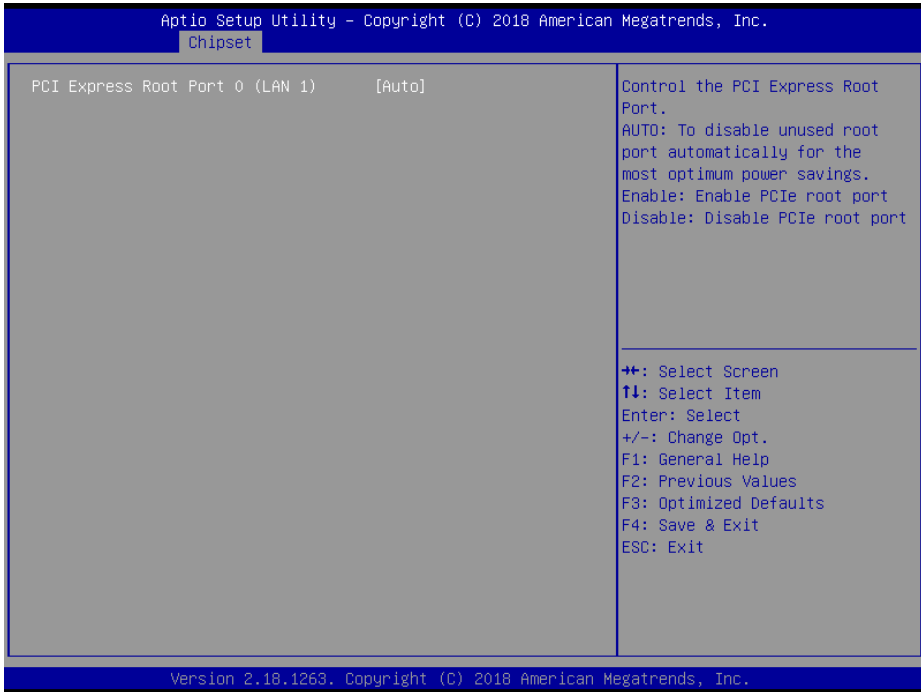

PCI Express Root Port 0 (LAN 1) Configuration Screen

BIOS Setting	Options	Description/Purpose
PCI Express Root Port 0 (LAN 1)	- Disabled - Enabled -Auto (default)	Enables or Disables PCI Express Root Port 0 (LAN 1). <ul style="list-style-type: none"> • Auto: Disables the unused Root Port automatically for saving the most optimum power. • Enabled: Enables PCI Express Root Port 0 (LAN 1). • Disabled: Disables PCI Express Root Port 0 (LAN 1).

Menu Path *Chipset > South Bridge > PCI Express Configuration > PCI Express Root Port 1 (LAN 2)*

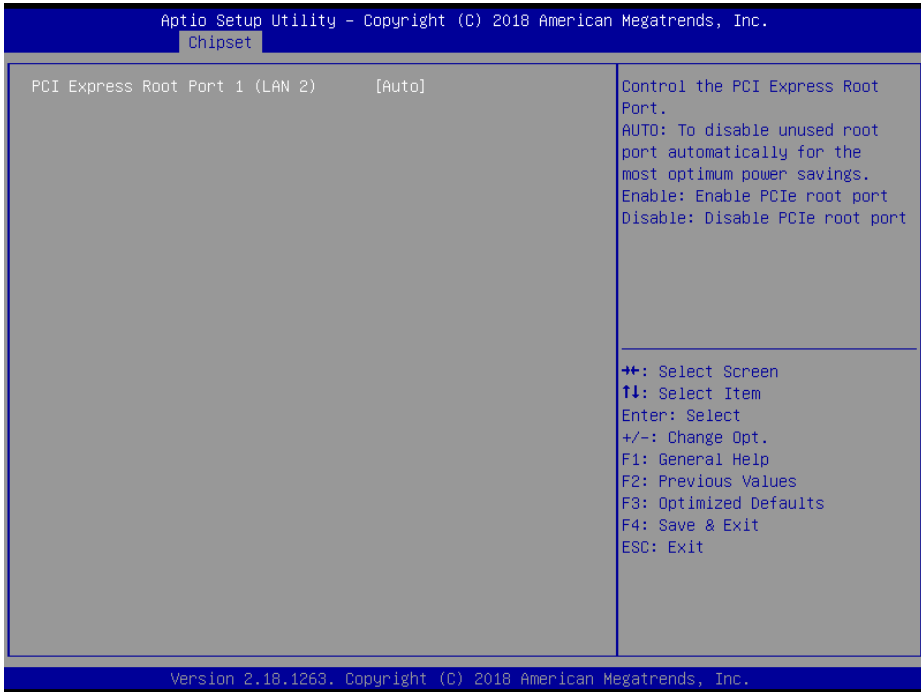

PCI Express Root Port 1 (LAN 2) Configuration Screen

BIOS Setting	Options	Description/Purpose
PCI Express Root Port 1 (LAN 2)	<ul style="list-style-type: none"> - Disabled - Enabled - Auto (default) 	Enables or Disables PCI Express Root Port 1 (LAN 2). <ul style="list-style-type: none"> • Auto: Disables the unused Root Port automatically for saving the most optimum power. • Enabled: Enables PCI Express Root Port 1 (LAN 2). • Disabled: Disables PCI Express Root Port 1 (LAN 2).

Menu Path *Chipset > South Bridge > PCI Express Configuration > Mini-PCI Express Root Port 1*

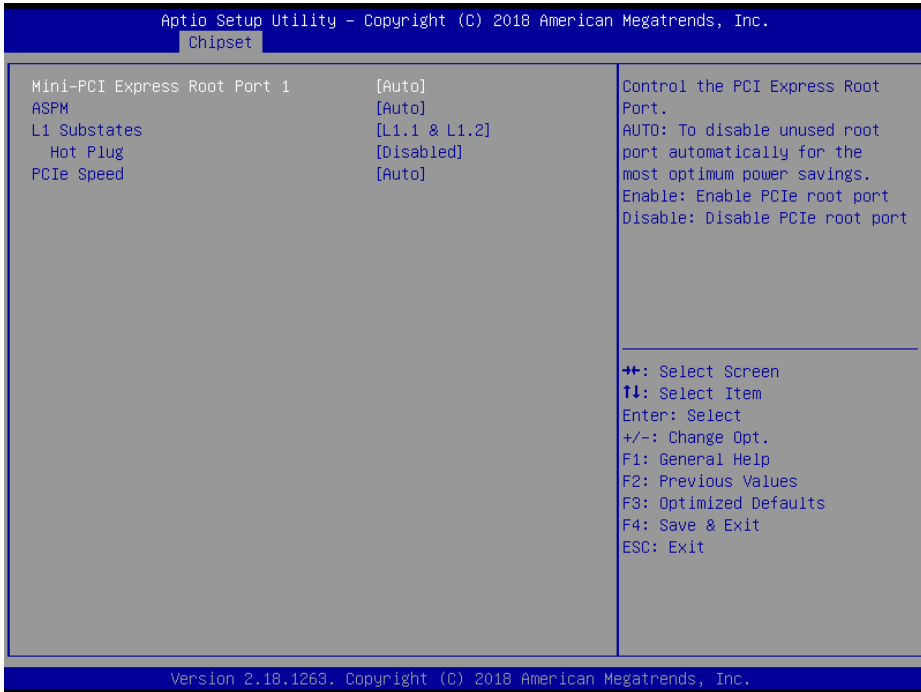

Mini-PCI Express Root Port 1 Configuration Screen

BIOS Setting	Options	Description/Purpose
Mini-PCI Express Root Port 1	- Disabled - Enabled - Auto (default)	Enables or Disables the Mini-PCI Express Root Port 1. <ul style="list-style-type: none"> • Auto: Disables the unused Root Port automatically for saving the most optimum power. • Enabled: Enables Mini-PCI Express Root Port 1. • Disabled: Disables Mini-PCI Express Root Port 1.
ASPM	- Disabled - L0s - L1 - L0sL1 - Auto	PCI Express Active State Power Management settings.

BIOS Setting	Options	Description/Purpose
L1 Substates	- Disabled - L1.1 - L1.2 - L1.1 & L1.2	PCI Express L1 Substates settings.
Hot Plug	- Disabled - Enabled	Enables or Disables PCI Express Hot Plug.
PCIe Speed	- Auto - Gen1 - Gen2	Selects PCI Express Port Speed.

Menu Path *Chipset > South Bridge > SATA Drives*

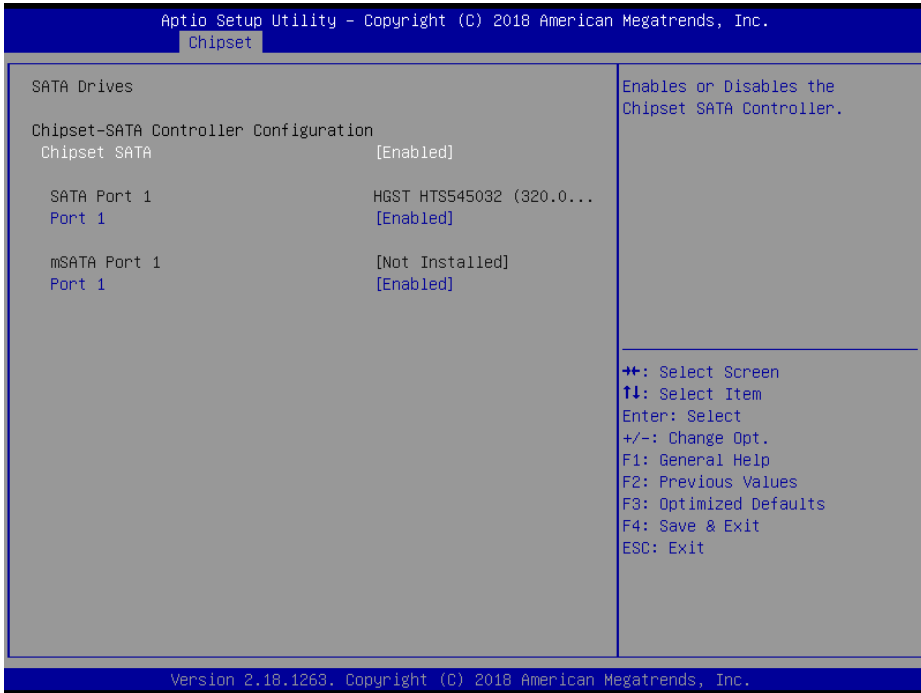

SATA Drives Screen

BIOS Setting	Options	Description/Purpose
Chipset SATA	- Disabled - Enabled	Enables or Disables the Chipset SATA Controller.
SATA Port 1	No changeable options	Displays the connected device on SATA Port 1.
Port 1	- Disabled - Enabled	Enables or Disables SATA Port 1.
mSATA Port 1	No changeable options	Displays the connected device on mSATA Port 1
Port 1	- Disabled - Enabled	Enables or Disables mSATA Port 1.

Menu Path *Chipset > South Bridge > Miscellaneous Configuration*

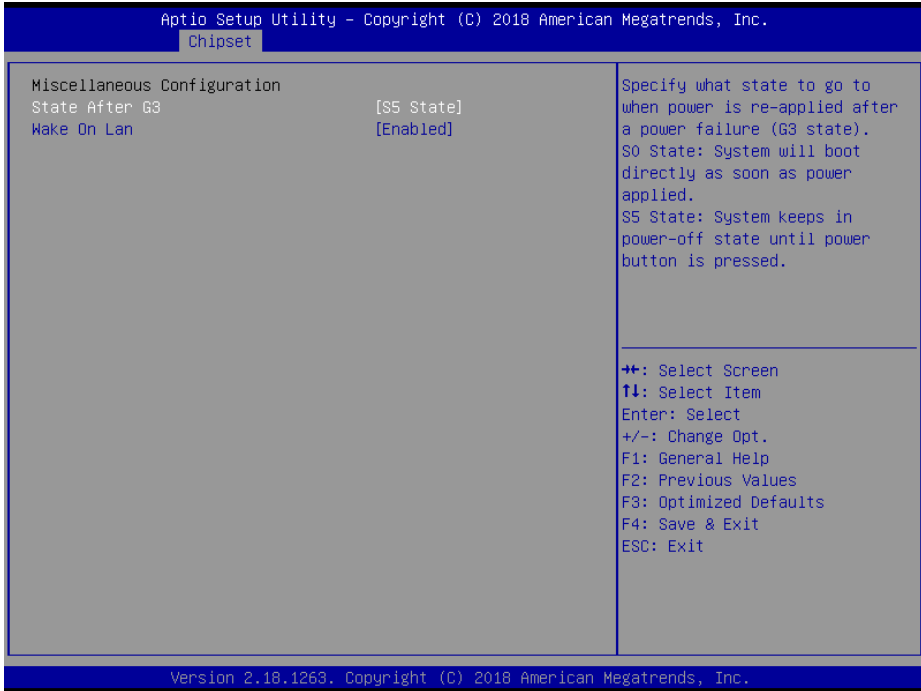

Miscellaneous Configuration Screen

BIOS Setting	Options	Description/Purpose
State After G3	- S0 State - S5 State	Specifies what state to go to when power is re-applied after power failure (G3 state). <ul style="list-style-type: none"> • S0 State: System will boot directly as soon as power applied. • S5 State: System keeps in power-off state until power button is pressed.
Wake On Lan	- Disabled - Enabled	Enables or Disables the Wake-On-LAN (WOL).

5.6 Security

Menu Path *Security*

From the **Security** menu, you are allowed to create, change or clear the administrator password. You will be asked to enter the configured administrator password before you can access the Setup Utility.

By setting an administrator password, you will prevent other users from changing your BIOS settings. You can configure an Administrator password and then configure a user password. An administrator has much more privileges over the settings in the Setup utility than a user. Heed that a user password does not provide access to most of the features in the Setup utility.

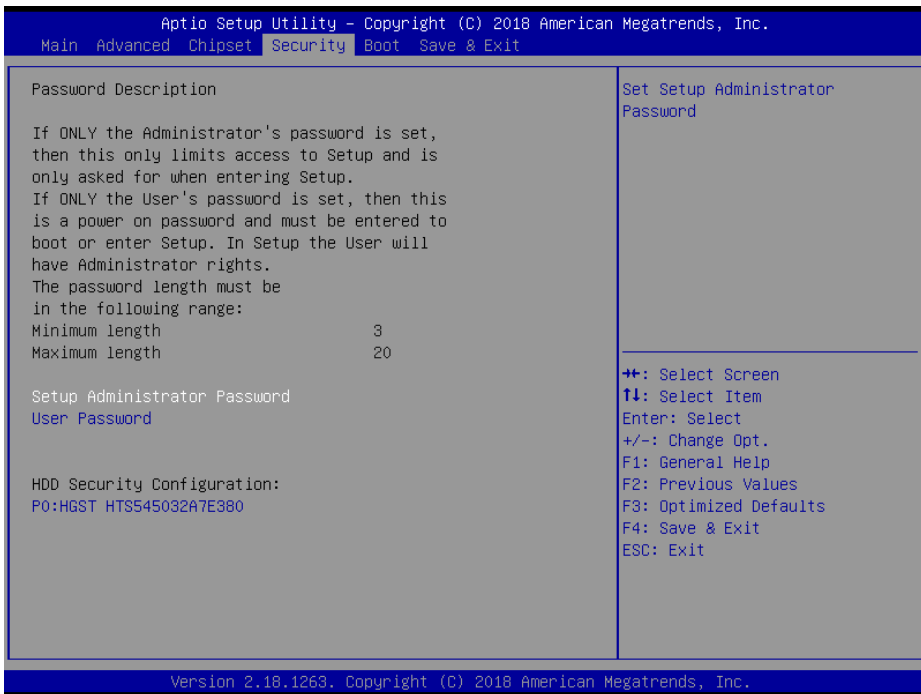

Security Screen

BIOS Setting	Options	Description/Purpose
Setup Administrator Password	Password can be 3-20 alphanumeric characters.	Specifies the administrator password.
User Password	Password can be 3-20 alphanumeric characters.	Specifies the user password.

Create an Administrator or User Password

1. Select the **Administrator Password / User Password** option from the Security menu and press <Enter>, and the password dialog entry box appears.
2. Enter the password you want to create. A password can be 3-20 alphanumeric characters. After you have configured the password, press <Enter> to confirm.
3. Type the new password again and press <Enter>.

Change an Administrator or User Password

1. Select the **Administrator Password / User Password** option from the Security menu and press <Enter>, and the password dialog entry box appears.
2. Select the Administrator Password or User Password that you want to change. A password can be 3-20 alphanumeric characters. After you have changed the password, press <Enter> to confirm.
3. Type the changed password again and press <Enter>.

Remove an Administrator or User Password

1. Select the **Administrator Password / User Password** option from the Security menu and press <Enter>, and the password dialog entry box appears.
2. Select the configured Administrator Password or User Password that you want to delete. Leave the dialog box blank and press <Enter>.
3. Press <Enter> again when the password confirmation box appears.

5.7 Boot

Menu Path Boot

This menu provides control items for setting system boot configuration and boot priorities.

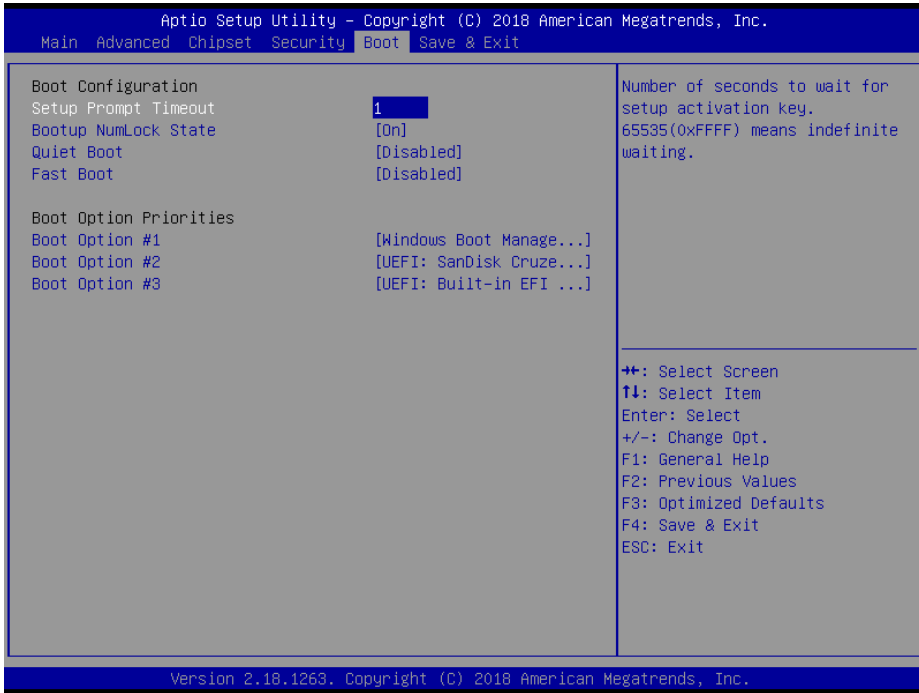

Boot Screen

BIOS Setting	Options	Description/Purpose
Setup Prompt Timeout	Numeric (from 1 to 65535)	Number of seconds to wait for setup activation key.
Bootup NumLock State	- On - Off	Selects the NumLock state after the system is powered on. <ul style="list-style-type: none"> • On: Enables the NumLock function automatically after the system is powered on. • Off: Disables the NumLock function after the system is powered on.
Quiet Boot	- Disabled - Enabled	Enables or Disables Quiet Boot options. When this option is set to “Disabled”, BIOS will display normal POST messages.

BIOS Setting	Options	Description/Purpose
Fast Boot	- Disabled - Enabled	Enables or Disables Fast Boot option. It allows users to reduce the system startup time and start up the system in a fast manner.
Boot Option #1~#n	- [Drive(s)] - Disabled	Allows users to change the boot order from the available device(s). Note that in the menu displayed, you will only see the device with the highest priority for a specific boot device type.

5.8 Save & Exit

Menu Path *Save & Exit*

The **Save & Exit** allows users to save or discard changed BIOS settings as well as load factory default settings.

Save Changed BIOS Settings

To save and validate the changed BIOS settings, select **Save Changes** from the **Save & Exit** menu, or you can select **Save Changes and Exit** (or press **F4**) to validate the changes and then exit the system. Select **Save Changes and Reset** to validate the changed BIOS settings and then restart the system

Discard Changed BIOS Settings

To cancel the BIOS settings you have previously configured, select **Discard Changes and Exit** from this menu, or simply press **Esc** to exit the BIOS setup. You can also select **Discard Changes and Reset** to discard any changes you have made and restore the factory BIOS defaults.

Load User Defaults

You may simply press **F3** at any time to load the **Optimized Values** which resets all BIOS settings to the factory defaults.

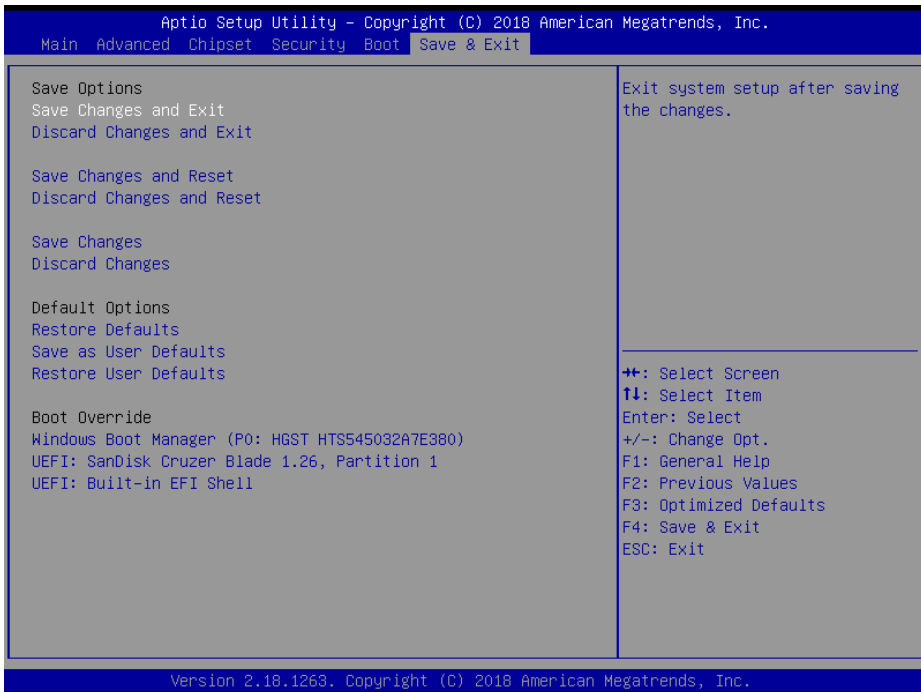

Save & Exit Screen

BIOS Setting	Options	Description/Purpose
Save Changes and Exit	No changeable options	Exits the system and saves the changes in NVRAM.
Discard Changes and Exit	No changeable options	Exits the system without saving any changes configured in BIOS settings.
Save Changes and Reset	No changeable options	Saves the changes in NVRAM and resets the system.
Discard Changes and Reset	No changeable options	Resets the system without saving any changes configured in BIOS settings.
Save Changes	No changeable options	Saves the changes done so far to any of the setup options.
Discard Changes	No changeable options	Discards the changes done so far to any of the BIOS settings.
Restore Defaults	No changeable options	Loads the optimized defaults for BIOS settings.
Save as User Defaults	No changeable options	Saves the changes done so far as User Defaults.
Restore User Defaults	No changeable options	Restores the User Defaults to all the BIOS settings.
Boot Override	- [Drive(s)]	Forces to boot the system from selected [drive(s)].

Appendix A System Diagrams

This appendix includes the exploded diagrams of the system and the parts list as well as the part numbers of the SP-6558 / 6550 system.

- SP-6558 System Exploded Diagram
- SP-6558 Touch Panel Exploded Diagram
- SP-6558 LCD Panel Exploded Diagram
- SP-6558 Panel Module Assembly Exploded Diagrams
- SP-6558 Speaker Exploded Diagram
- SP-6550 System Exploded Diagram
- SP-6550 Touch Panel Exploded Diagram
- SP-6550 LCD Panel Exploded Diagram
- SP-6550 Control Board Exploded Diagram

- SP-6558 / 6550 Wall O-ring Installation Exploded Diagram
- SP-6558 / 6550 Hook Installation Exploded Diagrams
- SP-6558 Wall Mount Installation Exploded Diagram
- SP-6558 / 6550 VESA Mount Installation Exploded Diagram
- SP-6558 / 6550 Heat Sink Exploded Diagram
- SP-6558 / 6550 Front & Rear I/O Panels Installation Exploded Diagram
- SP-6558 / 6550 Mother Board Exploded Diagram
- SP-6558 / 6550 HDD Module Exploded Diagram
- SP-6558 / 6550 Packing Exploded Diagram

SP-6558 System Exploded Diagram

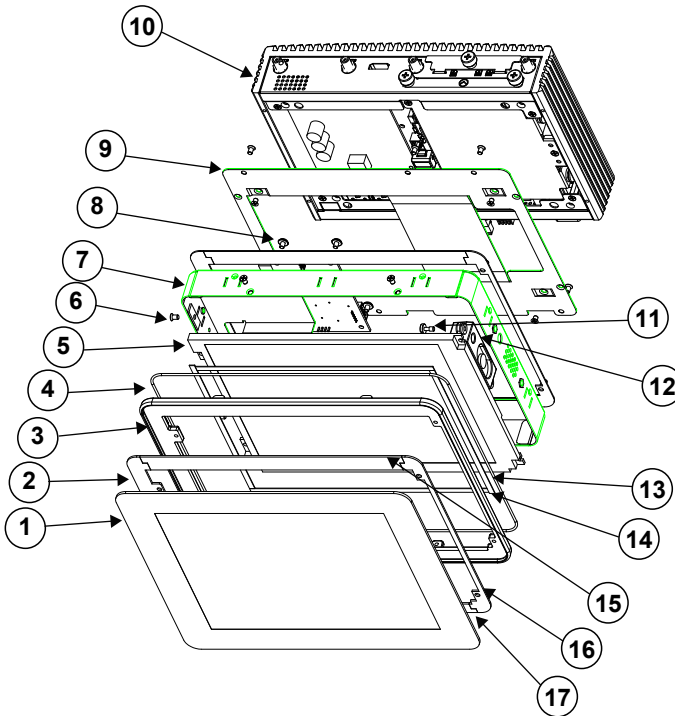

No.	Component Name	P/N No.	Q'ty
1	8.4" Zero Bezel 5-wire Resistive Touch Panel (-30~70°C)	52-380-06840128	1
2	SP-6558 GUM-L-SR	34-026-05016448	1
3	SP-6558 FRONT COVER	20-004-01062448	1
4	SP-6558 O RING	30-013-01200448	1
5	8.4" TFT LCD Panel (LED Backlight),600nits,SVGA(800x600)	52-351-00840230	1
6	FLAT HEAD SCREW #2 / M3x0.5Px5mm	22-215-30005011	20
7	SP-6558 REAR COVER	20-104-03062448	1
8	Round Washer Head Screw #2 / M3x0.5Px4mm	22-232-30004011	4
9	SP-6558 PPC BOTTOM BRACKET	20-106-03001448	1
10	SP-6558RA-A0B(B0B)		1
11	Fillister Head Screw M3x0.5Px3mm	22-275-30003039	2
12	Speaker		1
13	LCD PORON-V FOR 10.4" PANEL	30-013-24600000	2
14	LCD PORON-H FOR 10.4" PANEL	30-013-24700000	2
15	SP-6558 GUM-T-SR	34-026-05013448	1
16	SP-6558 GUM-R-SR	34-026-05011448	1
17	SP-6558 GUM-D-SR	34-026-05009448	1

SP-6558 Touch Panel Exploded Diagram

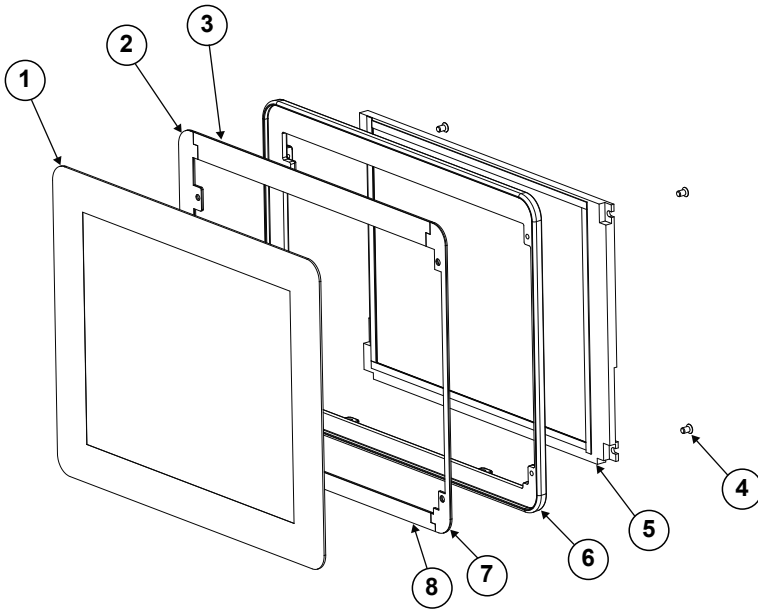

No.	Component Name	P/N No.	Q'ty
1	8.4" Zero Bezel 5-wire Resistive Touch Panel(-30~70°C)	52-380-06840128	1
	8.4" Zero Bezel P-CAP Touch Panel(COF)(-30~70°C)	52-380-06800028	1
2	SP-6558 GUM-L-SR (171.8x18.59x0.8mm)	34-026-05016448	1
	SP-6558 GUM-L-SP (171.8x18.59x1.3mm)	34-026-05015448	1
3	SP-6558 GUM-T-SR (195.28x13.16x0.8mm)	34-026-05013448	1
	SP-6558 GUM-T-SP (195.28x13.25x1.3mm)	34-026-05012448	1
4	FLAT HEAD SCREW #2 / M3x0.5Px5mm	22-215-30005011	4
5	8.4" TFT LCD Panel (LED Backlight),600nits,SVGA (800x600)	52-351-00840230	1
6	SP-6558 FRONT COVER(w/Paint)(Black)	20-004-01062448	1
7	SP-6558 GUM-R-SR (171.8x15.85x0.8mm)	34-026-05011448	1
	SP-6558 GUM-R-SP (171.8x15.85x1.3mm)	34-026-05010448	1
8	SP-6558 GUM-D-SR (195.28x8.36x0.8mm)	34-026-05009448	1
	SP-6558 GUM-D-SP (195.28x8.36x1.3mm)	34-026-05014448	1

SP-6558 LCD Panel Exploded Diagram

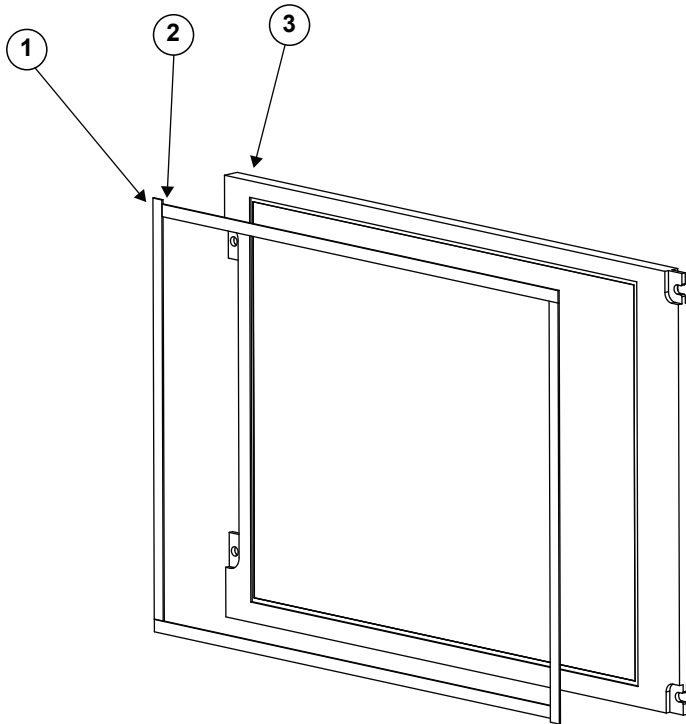

No.	Component Name	P/N No.	Q'ty
1	LCD PORON FOR 10.4" PANEL(167x4x0.5mm)	30-013-24700000	2
2	LCD PORON FOR 10.4" PANEL (220x4x0.5mm)	30-013-24600000	2
3	8.4" TFT LCD Panel (LED Backlight),600nits,SVGA (800x600)	52-351-00840230	1

SP-6558 Panel Module Assembly Exploded Diagram (1)

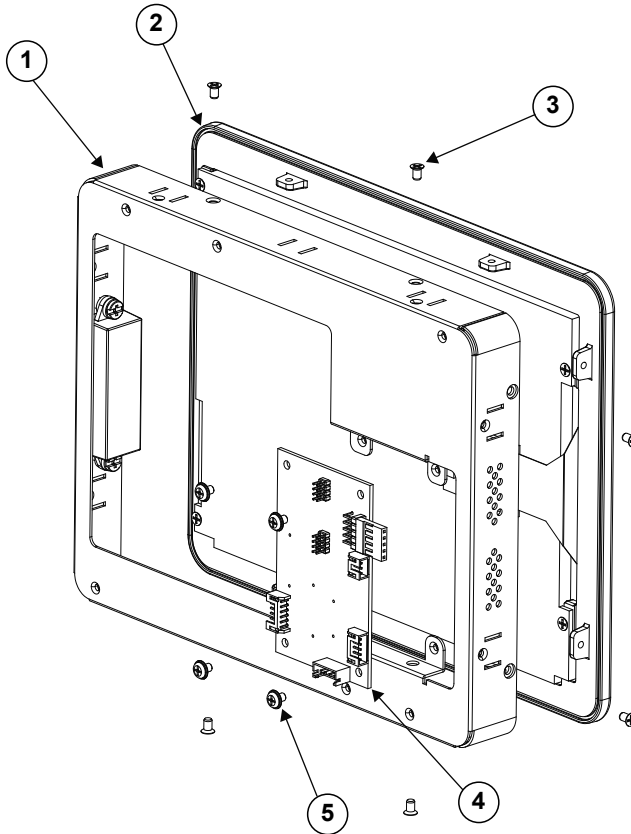

No.	Component Name	P/N No.	Q'ty
1	SP-6558 Rear Cover (w/Paint)(Black)	20-104-03062448	1
2	SP-6558 Front Cover (w/Paint)(Black)	20-004-01062448	1
3	FLAT HEAD SCREW #2 / M3x0.5Px5mm	22-215-30005011	6
4	Touch Control Board for P-CAP,USB&RS232 Interface (Abon Touch)	52-370-01623007	1
5	ROUND WASHER HEAD SCREW #2 / M3x0.5Px4mm	22-232-30004011	4

SP-6558 Panel Module Assembly Exploded Diagram (2)

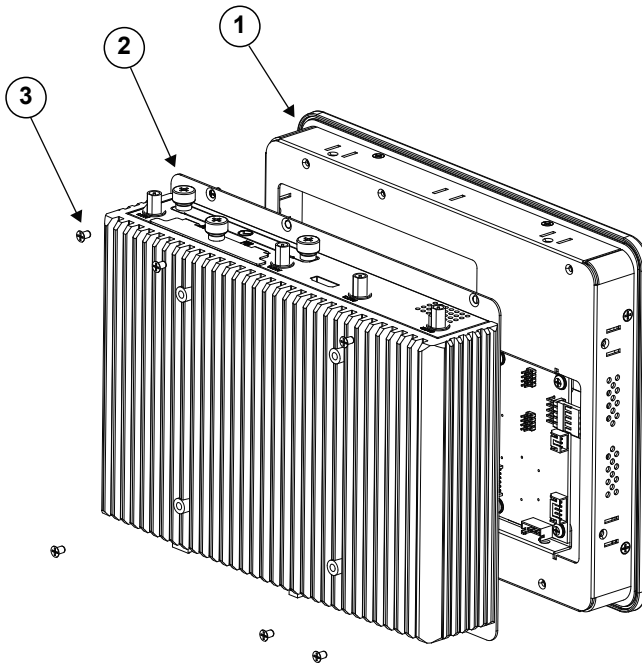

No.	Component Name	P/N No.	Q'ty
1	SP-6558 Rear Cover (w/Paint)(Black)	20-104-03062448	1
2	SE-8134		1
3	FLAT HEAD SCREW #2 /M3x0.5Px5mm	22-215-30005011	6

SP-6558 Speaker Exploded Diagram

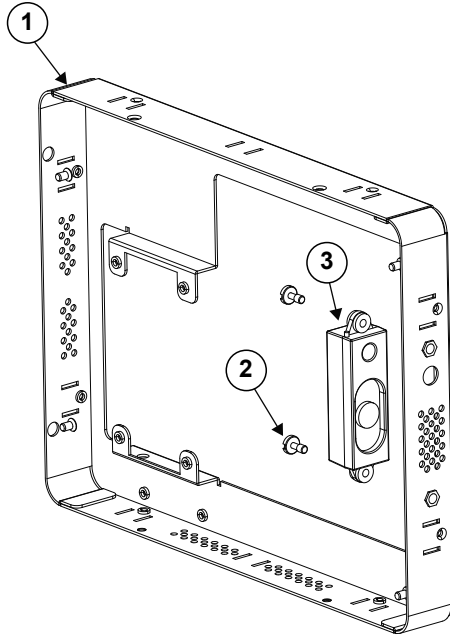

No.	Component Name	P/N No.	Q'ty
1	SP-6558 REAR COVER	20-104-03062448	1
2	FILLISTER HEAD SCREW M3x0.5Px3mm(Black)	22-275-30003039	2
3	Speaker		1

SP-6550 System Exploded Diagram

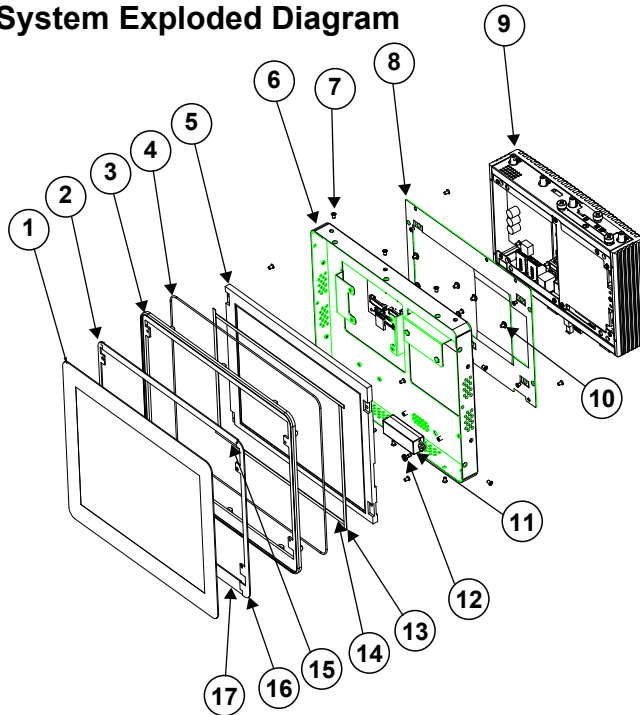

No.	Component Name	P/N No.	Qty
1	10.4" Zero Bezel 5-wire Resistive Touch Panel (-30~70°C) (AbonTouch)	52-380-01200114	1
	10.4" Zero Bezel P-CAP Touch Panel(COF)(-30~70°C) (AbonTouch)	52-380-01085014	1
2	SP-6550 GUM-L-SR (211.4x16.62x0.8mm)	34-026-05004448	1
3	SP-6550 FRONT COVER (Black)	20-004-01061448	1
4	SP-6550 O RING	30-013-01100448	1
5	10.4" TFT LCD Panel(LED Backlight),400nits,SVGA(800x600)	52-351-01104102	1
6	SP-6550 REAR COVER(w/Paint)(Black)	20-104-03061448	1
7	FLAT HEAD SCREW #2 / M3x0.5Px5mm	22-215-30005011	18
8	PPC BOTTOM BRACKET	20-106-03001448	1
9	SP-6550RA-A0B (BOB)		1
10	M3 Screw	22-232-30004011	6
11	Speaker		1
12	M3 Screw	22-275-30003039	2
13	LCD PORON FOR 10.4" PANEL(167x4x0.5mm)	30-013-24700000	2
14	LCD PORON FOR 10.4" PANEL(220x4x0.5mm)	30-013-24600000	2
15	SP-6550 GUM-TOP-SR	34-026-05008448	1
16	SP-6550 GUM-R-SR	34-026-05006448	1
17	SP-6550 GUM-D-SR	34-026-05002448	1

SP-6550 Touch Panel Exploded Diagram

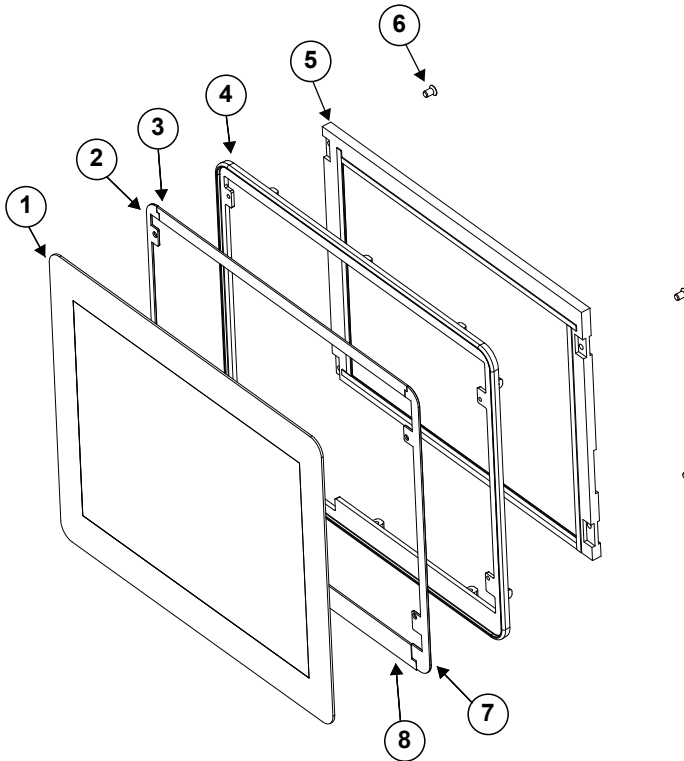

No.	Component Name	P/N No.	Q'ty
1	10.4" Zero Bezel 5-wire Resistive Touch Panel (-30~70°C) (AbonTouch)	52-380-01200114	1
	10.4" Zero Bezel P-CAP Touch Panel(COF)(-30~70°C)(AbonTouch)	52-380-01085014	1
2	GUM-R-SR(211.4x16.62x0.8mm)	34-026-05006448	1
	GUM-R-SP (211.4x16.62x1.1mm)	34-026-05005448	1
3	GUM-TOP-SR (235.1x7.8x0.8mm)	34-026-05008448	1
	GUM-T-SP (235.1x7.8x1.1mm)	34-026-05007448	1
4	FRONT COVER(w/Paint)(Black)	20-004-01061448	1
5	10.4" TFT LCD Panel(LED Backlight),400nits,SVGA (800x600)	52-351-01104102	1
6	FLAT HEAD SCREW #2 / M3x0.5Px5mm	22-215-30005011	4
7	GUM-L-SR (211.4x16.62x0.8mm)	34-026-05004448	1
	GUM-L-SP (211.4x16.62x1.1mm)	34-026-05003448	1
8	GUM-D-SR (229.74x15.3x0.8mm)	34-026-05002448	1
	GUM-D-SP (229.54x15.3x1.1mm)	34-026-05001448	1

SP-6550 LCD Panel Exploded Diagram

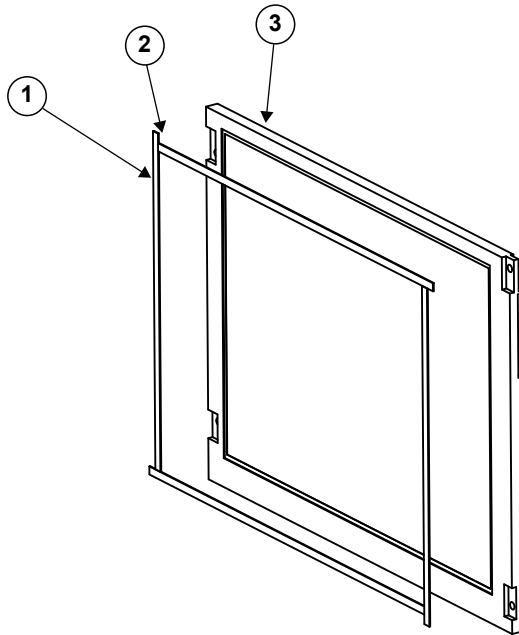

No.	Component Name	P/N No.	Q'ty
1	LCD PORON FOR 10.4\"/>	30-013-24700000	2
2	LCD PORON FOR 10.4\"/>	30-013-24600000	2
3	10.4\"/>	52-351-01104102	1

SP-6550 Control Board Exploded Diagram

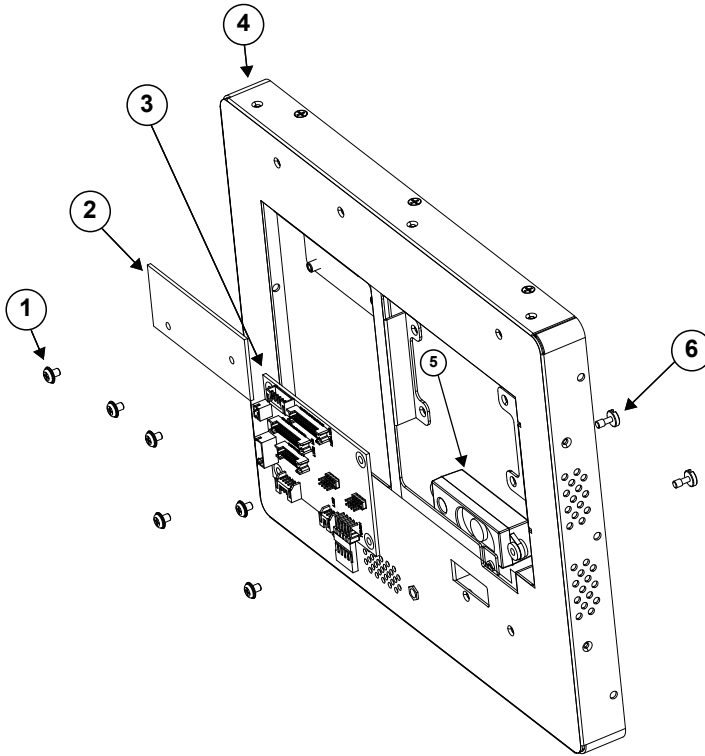

No.	Component Name	P/N No.	Q'ty
1	ROUND WASHER HEAD SCREW #2 / M3x0.5Px4mm	22-232-30004011	6
2	Sunlight		1
3	Touch Control Board for P-CAP,USB&RS232 Interface (Abon Touch)	52-370-01623007	1
4	SP-6550 REAR COVER(w/Paint)(Black)	20-104-03061448	1
5	Speaker		1
6	FILLISTER HEAD SCREW M3x0.5Px3mm(Black)	22-275-30003039	2

SP-6558 / SP-6550 Wall O-ring Installation Exploded Diagram

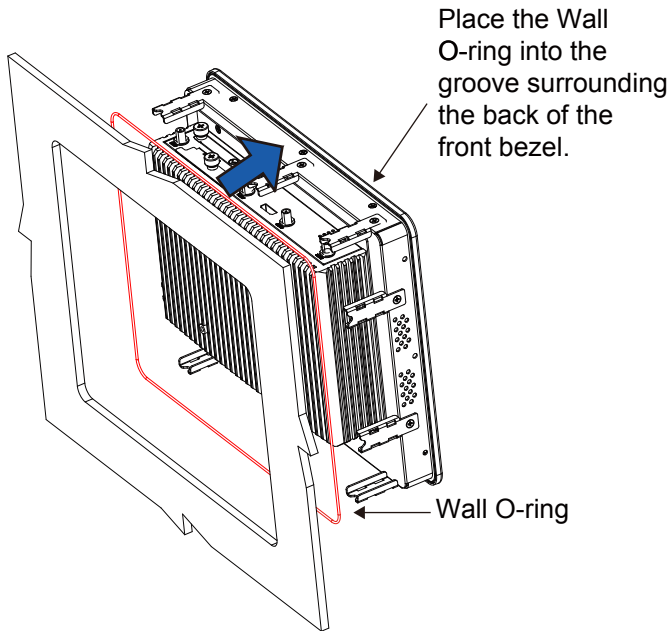

Component Name	P/N No.	Q'ty
SP-6558 O RING	30-013-01200448	1
SP-6550 O RING	30-013-01100448	1

SP-6558 Hook Installation Exploded Diagram (1)

Step 1. Install SP-6658 system on the wall firmly.

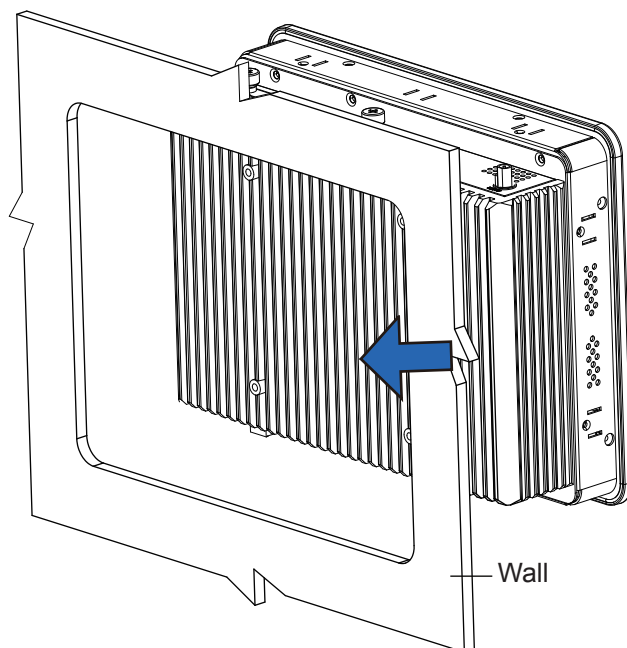

SP-6558 Hook Installation Exploded Diagram (2)

Step 2. Install 10 mounting hooks on the four sides of Panel PC and fasten the mating screws to secure firmly.

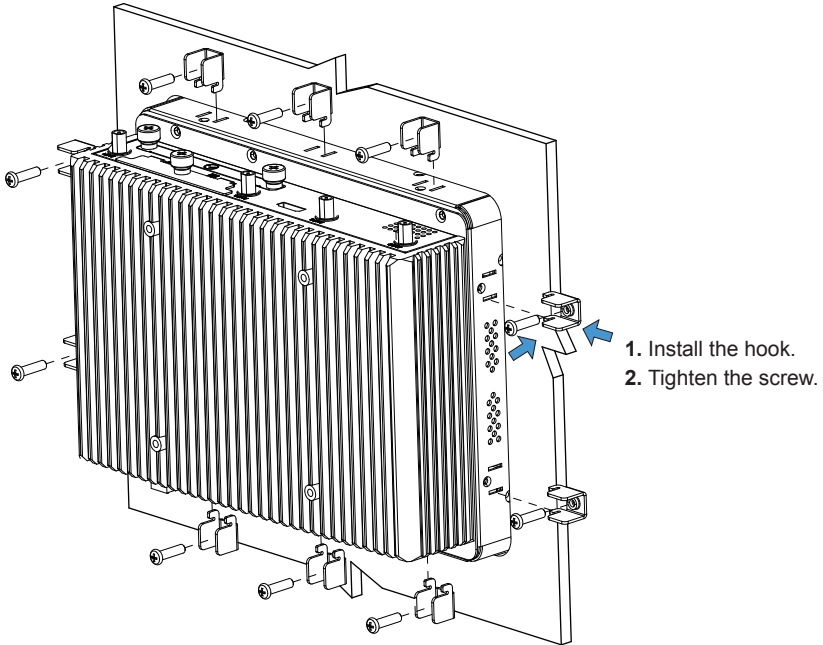

SP-6558 Wall Mount Installation Exploded Diagram

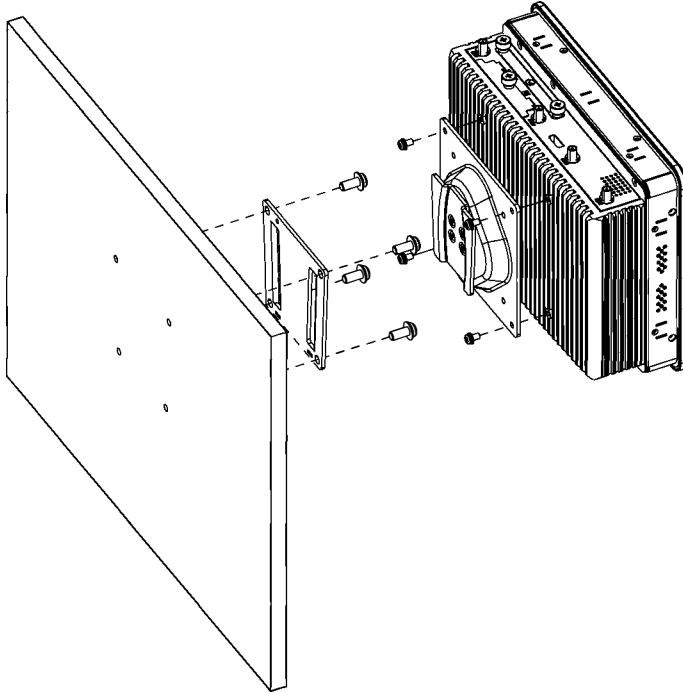

SP-6550 Hook Installation Exploded Diagram (1)

Step 1. Install the mounting brackets into the mounting holes on the four sides SP-6550 using 9 x screws (M3x5mm).

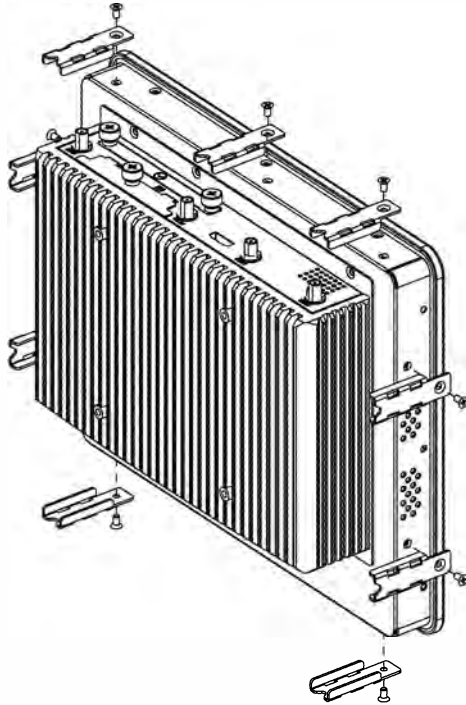

SP-6550 Hook Installation Exploded Diagram (2)

Step 2. Mount SP-6550 Panel PC equipped with 9 brackets onto the wall firmly.

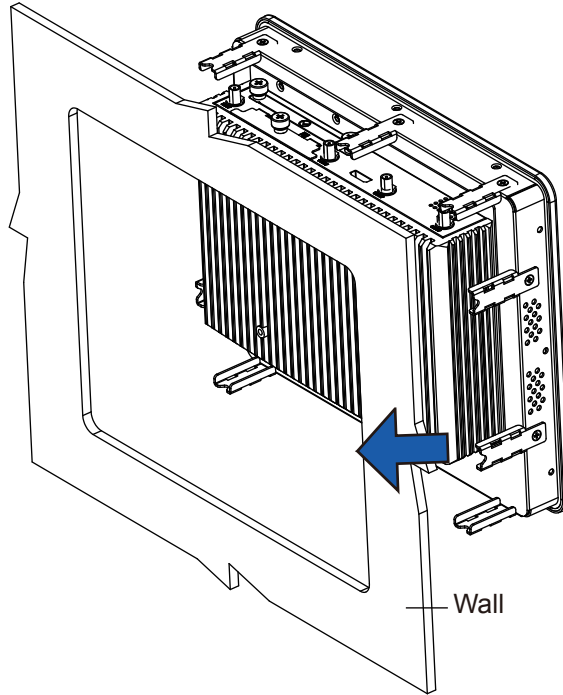

SP-6550 Hook Installation Exploded Diagram (3)

Step 3. Install 9 hooks onto the mounting brackets on the four sides of Panel PC and fasten the mating screws to secure firmly.

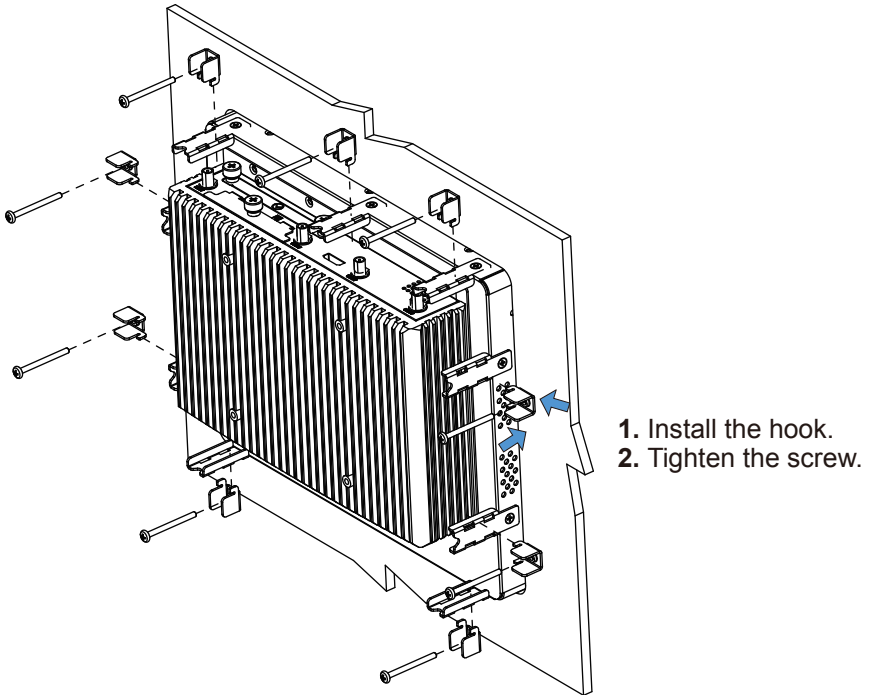

SP-6550 VESA Mount Installation Exploded Diagram

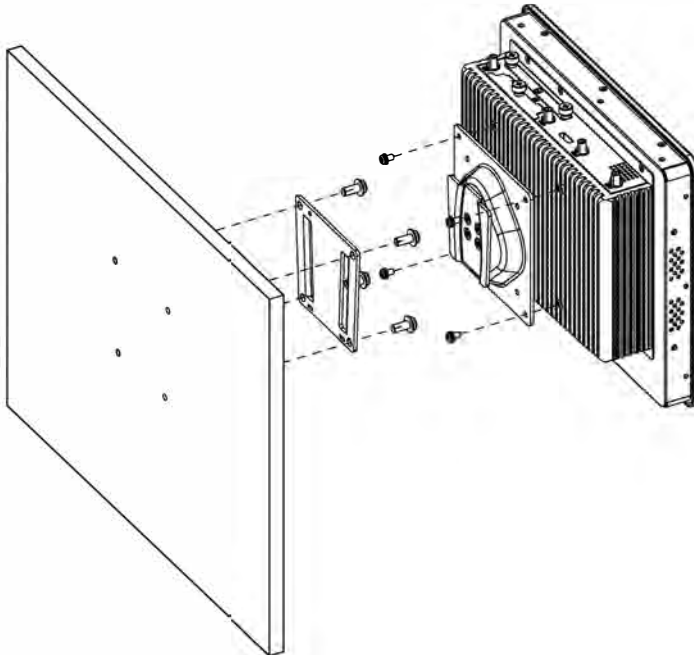

SP-6558 / 6550 Heat Sink Exploded Diagram

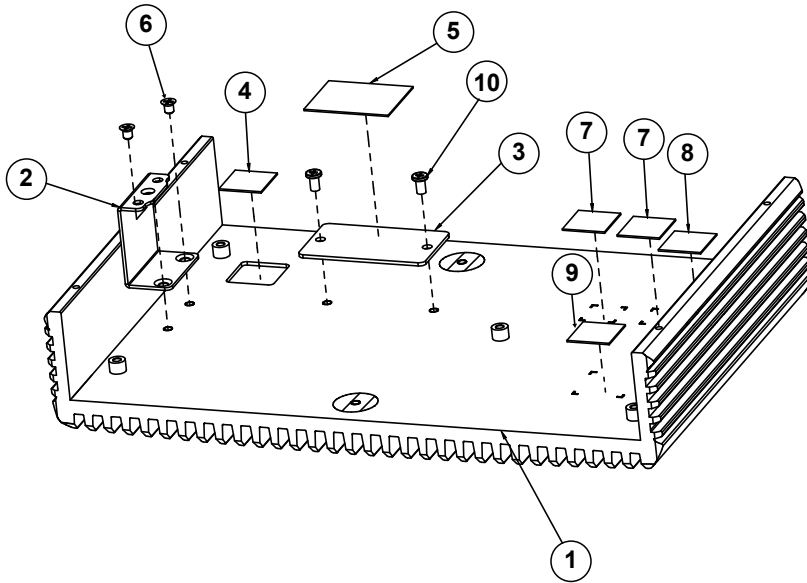

No.	Component Name	Part No.	Q'ty
1	Heat Sink Main Case (207.5x140.6x32mm)	Black	1
		Silver	
2	HDD Support Side Bracket	20-006-03002401	1
3	CPU Conduction Block	E3950 (45x25x1.2mm)	81-002-24525001
		N3350 (45x25x2.2mm)	81-002-24525002
4	Choke Thermal Pad (15x15x1.0mm)	81-006-81515007	1
5	CPU Thermal Pad (13x13x1mm)	81-006-81313003	1
6	Flat Head Screw-M3x0.5Px4mm(Black)	22-215-30004011	2
7	LAN Thermal Pad (10x10x4.0mm)	81-006-81010005	2
8	Audio Thermal Pad (7x7x3.5mm)	81-006-80707001	1
9	PCH Thermal Pad (15x15x3.0mm)	81-006-81515006	1
10	Fillister Head Screw#2/M3x0.5Px5mm	22-272-30049015	2

SP-6558 / 6550 Front & Rear I/O Panels Installation Exploded Diagram

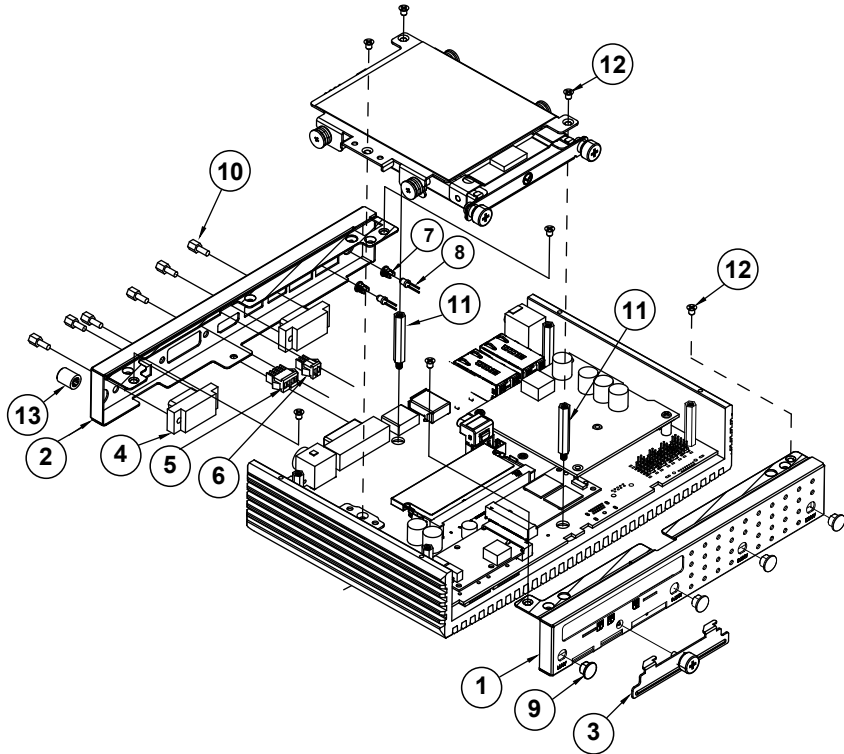

Please see the next page for the part numbers of the exploded diagram above.

No.	Component Name	Part No.	Q'ty
1	Front I/O Plate	Silver	20-005-03065401
		Blue	20-005-03066401
2	Back I/O Plate	Silver	20-005-03062401
		Blue	20-005-03061401
3	SIM / SD Cover	Silver	20-004-03064401
		Blue	20-004-03063401
4	COM Port Cable		2
5	I2C Cable		1
6	Remote SW. Cable		1
7	LED Housing	30-014-04100165	2
8	PoE LED Cable	27-018-40102071	2
9	Hole Plug (Φ6.6mm) (Black)	90-067-01100000	4
10	HEX CU BOSS UNC No.4-40, L=4.8, H=7mm	22-692-40048051	6
11	HEX CU BOSS(NI) M3x0.5Px4.5L,H=28.5mm	22-252-30029901	2
12	Flat Head Screw M3x0.5Px4mm(Black)	22-215-30004011	7
13	Power Button Cover	30-001-28100099	1

SP-6558 / 6550 Mother Board Exploded Diagram

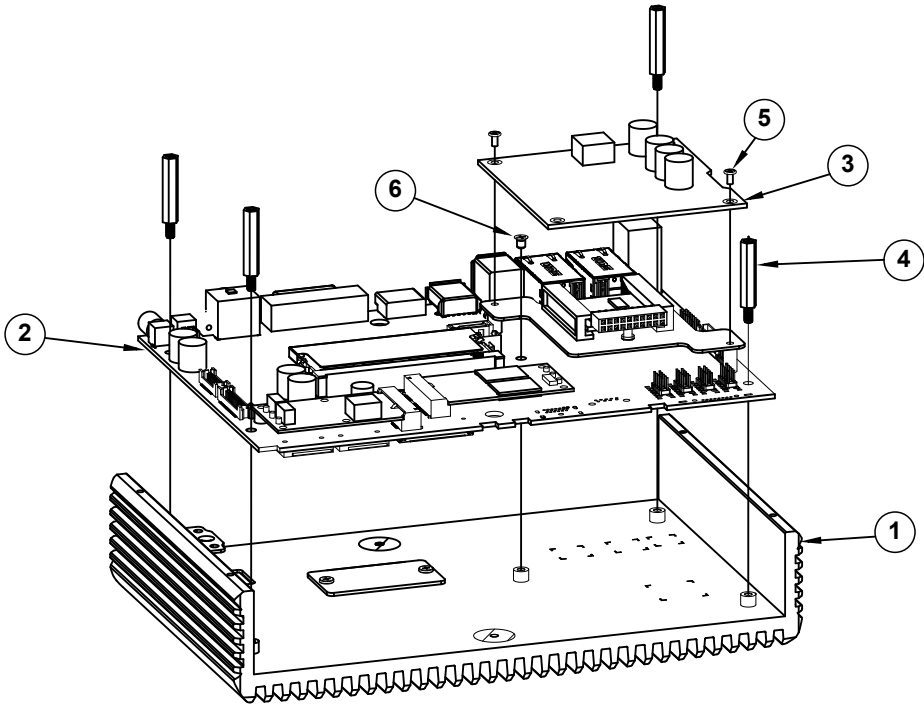

No.	Component Name		Part No.	Q'ty
1	Heat Sink Assembly	Black	81-002-11841003	1
		Silver	81-002-11841004	
2	SB-8134 M/B			1
3	PoE Board		SR-8134RB-D0N	1
4	HEX CU BOSS(NI) M3x0.5Px6L, H=24.7mm		22-252-30025901	4
5	FILLISTER HEAD SCREW#1 / M2x0.4Px4mm		22-272-20004011	2
6	FLAT HEAD SCREW#2 / M3x0.5Px5mm		22-215-30005011	1

SP-6558 / 6550 HDD Module Exploded Diagram

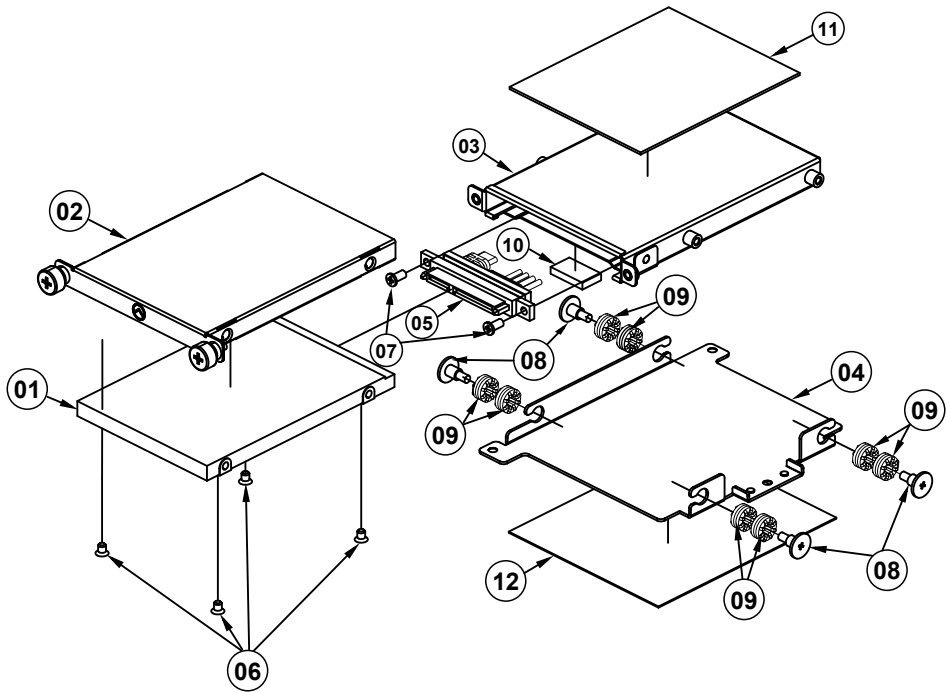

No.	Component Name	Part No.	Q'ty
1	2.5" HDD / SSD	N/A	1
2	SE-8134 HDD Tray (w/Paint) (Pantone 2188C)	20-054-03061401	1
	SE-8134 HDD Tray (w/Paint) (Pantone 877C)	20-054-03062401	
3	SE-8134 HDD CABLE HOLDER ASM	20-029-03001401	1
4	SE-8134 HDD Support Bracket	20-006-03001401	1
5	HDD CABLE	N/A	1
6	Flat Head Screw #2/M3x0.5Px5mm (Black)	22-215-30005011	4
7	Fillister Head Screw #2/M3x0.5Px5mm	22-272-30049015	2
8	Fillister Head Screw M3x0.5Px4.8mm	82-272-30005013	4
9	Rubber Washer (OD=φ9.62mm, ID=φ3.9mmx5.8T) (Blue)	23-680-39580963	8
10	EMI Shielding Gasket (17x10x3mm)	90-050-31300165	1
11	Thermal Interface Pads, K=6,85x70x1.0mm(Red)	81-006-88570001	1
12	Thermal Interface Pads, K=12,95x80x0.5mm (Gray)	81-006-89585001	1

SP-6558 / 6550 Packing Exploded Diagram
SP-6558 Packing Exploded Diagram

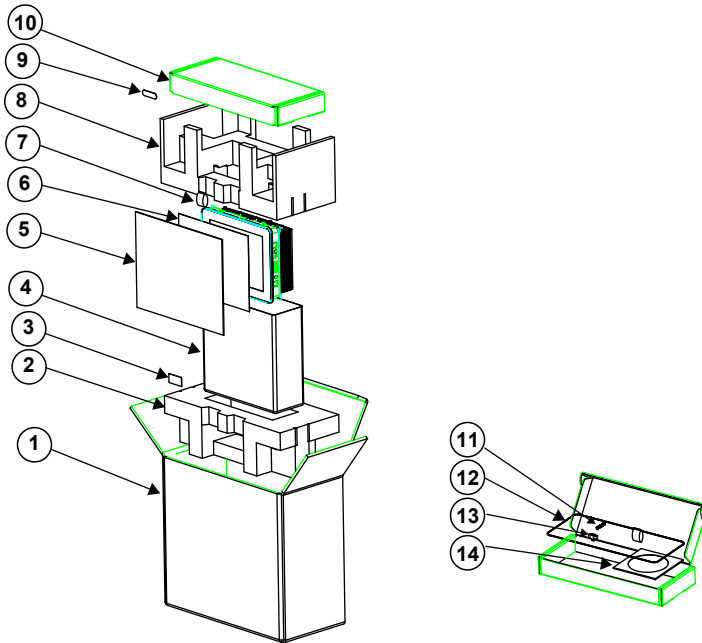

No.	Component Name	P/N No.	Q'ty
1	ST-1082 OUTER CARTON (382x185x337mm)	94-001-01301237	1
2	SP-6558 / 6550 EPE Down		1
3	SP-6558RX-XXX Rating Label(41x21mm)	94-017-01904448	1
4	PE Bag 480x460 (42X56cmX0.07)	32-10020010000	1
5	CARDBOARD (280-224-2.2mm)	34-004-01801009	1
6	LCD MYLAR FOR 8INCH	30-056-16100000	1
7	SILICA GEL 1gm	34-005-00010007	2
8	SP-6558 / 6550 EPE Top		1
9	2016 Prox Flat Label	34-017-02103000	1
10	PS-650X CARTON BOXES(332x150x45mm)	34-003-01301086	1
11	MINI JUMPER 2.0mm (CLOSE Type), DIP	10-611-00200023	5
12	Terminal Block, Pin=2, Pitch=5.08mm	10-625-00200047	1
13	SP-6558 O RING	30-013-01200448	1
14	DVD-R (w/Protech logo) For OBM	52-601-02000005	1
	SP-6558 System	N/A	1
	PPC-6558/6550 Quick Manual (A3) (Q1)		1

SP-6550 Packing Exploded Diagram

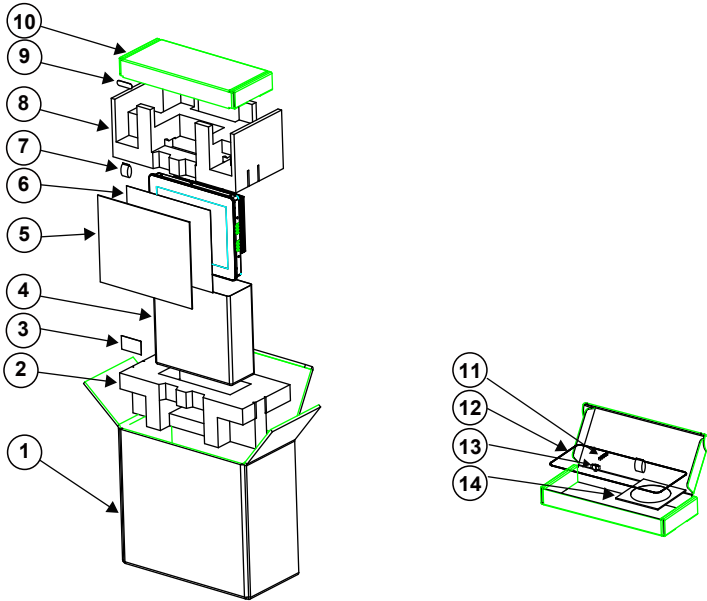

No.	Component Name	P/N No.	Q'ty
1	ST-1082 OUTER CARTON (382x185x337mm)	94-001-01301237	1
2	SP-6558 / 6550 EPE Down		1
3	SP-6558RX-XXX Rating Label(41x21mm)	94-017-01904448	1
4	PE Bag 480x460(42x56cmx0.07)	32-10020010000	1
5	CARDBOARD (280-224-2.2mm)	34-004-01801009	1
6	PPC-7360 mylar for display	30-056-16200009	1
7	SILICA GEL 1gm	34-005-00010007	2
8	SP-6558 / 6550 EPE Top		1
9	2016 Prox Flat Label	34-017-02103000	1
10	PS-650X CARTON BOXES (332x150x45mm)	34-003-01301086	1
11	MINI JUMPER 2.0mm (CLOSE Type), DIP	10-611-00200023	5
12	SP-6550 O RING	30-013-01100448	1
13	Terminal Block, Pin=2, Pitch=5.08mm	10-625-00200047	1
14	DVD-R (w/Protech logo) For OBM	52-601-02000005	1
	SP-6550 System	N/A	1
	PPC-6558/6550 Quick Manual (A3) (Q1)		1

Appendix B Technical Summary

This appendix will give you a brief introduction of the allocation maps for the system resources.

The following topics are included:

- System Block Diagram
- Interrupt Map
- I/O Map
- Memory Map
- Configuring WatchDog Timer
- Flash BIOS Update

System Block Diagram

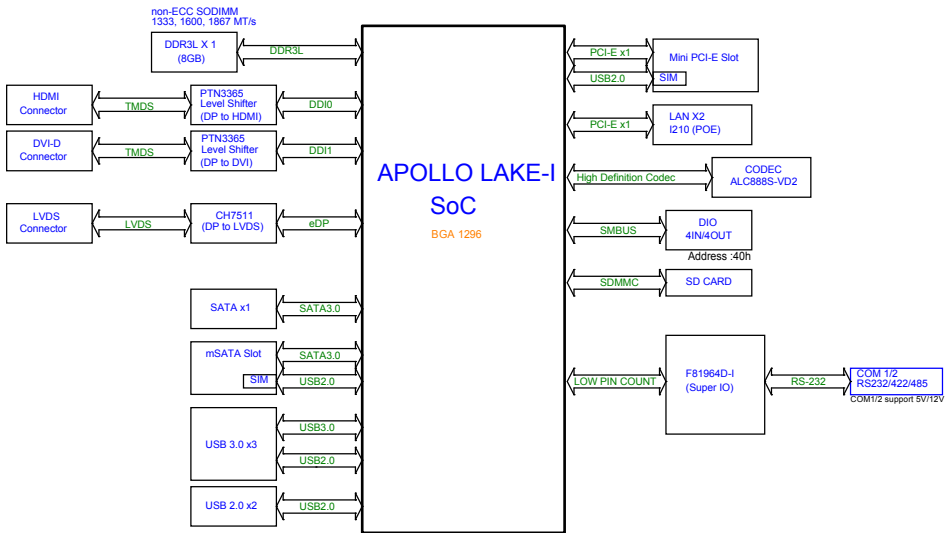

Interrupt Map

IRQ	ASSIGNMENT
IRQ 0	System timer
IRQ 3	Intel SD Host Controller
IRQ 4	Communications Port (COM1)
IRQ 6	Communications Port (COM2)
IRQ 8	System CMOS/real time clock
IRQ 14	Intel(R) Serial IO GPIO Host Controller - INT3452
IRQ 25	High Definition Audio Controller
IRQ 31	Intel(R) Serial IO I2C Host Controller - 5AB4
IRQ 32	Intel(R) Serial IO I2C Host Controller - 5AB6
IRQ 54	Microsoft ACPI-Compliant System
IRQ 55	Microsoft ACPI-Compliant System
IRQ 56	Microsoft ACPI-Compliant System
IRQ 57	Microsoft ACPI-Compliant System
IRQ 58	Microsoft ACPI-Compliant System
IRQ 59	Microsoft ACPI-Compliant System
IRQ 60	Microsoft ACPI-Compliant System
IRQ 61	Microsoft ACPI-Compliant System
IRQ 62	Microsoft ACPI-Compliant System
IRQ 63	Microsoft ACPI-Compliant System
IRQ 64	Microsoft ACPI-Compliant System
IRQ 65	Microsoft ACPI-Compliant System
IRQ 66	Microsoft ACPI-Compliant System
IRQ 67	Microsoft ACPI-Compliant System
IRQ 68	Microsoft ACPI-Compliant System
IRQ 69	Microsoft ACPI-Compliant System
IRQ 70	Microsoft ACPI-Compliant System
IRQ 71	Microsoft ACPI-Compliant System
IRQ 72	Microsoft ACPI-Compliant System
IRQ 73	Microsoft ACPI-Compliant System
IRQ 74	Microsoft ACPI-Compliant System
IRQ 75	Microsoft ACPI-Compliant System
IRQ 76	Microsoft ACPI-Compliant System
IRQ 77	Microsoft ACPI-Compliant System

IRQ	ASSIGNMENT
IRQ 78	Microsoft ACPI-Compliant System
IRQ 79	Microsoft ACPI-Compliant System
IRQ 80	Microsoft ACPI-Compliant System
IRQ 81	Microsoft ACPI-Compliant System
IRQ 82	Microsoft ACPI-Compliant System
IRQ 83	Microsoft ACPI-Compliant System
IRQ 84	Microsoft ACPI-Compliant System
IRQ 85	Microsoft ACPI-Compliant System
IRQ 86	Microsoft ACPI-Compliant System
IRQ 87	Microsoft ACPI-Compliant System
IRQ 88	Microsoft ACPI-Compliant System
IRQ 89	Microsoft ACPI-Compliant System
IRQ 90	Microsoft ACPI-Compliant System
IRQ 91	Microsoft ACPI-Compliant System
IRQ 92	Microsoft ACPI-Compliant System
IRQ 93	Microsoft ACPI-Compliant System
IRQ 94	Microsoft ACPI-Compliant System
IRQ 95	Microsoft ACPI-Compliant System
IRQ 96	Microsoft ACPI-Compliant System
IRQ 97	Microsoft ACPI-Compliant System
IRQ 98	Microsoft ACPI-Compliant System
IRQ 99	Microsoft ACPI-Compliant System
IRQ 100	Microsoft ACPI-Compliant System
IRQ 101	Microsoft ACPI-Compliant System
IRQ 102	Microsoft ACPI-Compliant System
IRQ 103	Microsoft ACPI-Compliant System
IRQ 104	Microsoft ACPI-Compliant System
IRQ 105	Microsoft ACPI-Compliant System
IRQ 106	Microsoft ACPI-Compliant System
IRQ 107	Microsoft ACPI-Compliant System
IRQ 108	Microsoft ACPI-Compliant System
IRQ 109	Microsoft ACPI-Compliant System
IRQ 110	Microsoft ACPI-Compliant System
IRQ 111	Microsoft ACPI-Compliant System
IRQ 112	Microsoft ACPI-Compliant System
IRQ 113	Microsoft ACPI-Compliant System

IRQ	ASSIGNMENT
IRQ 114	Microsoft ACPI-Compliant System
IRQ 115	Microsoft ACPI-Compliant System
IRQ 116	Microsoft ACPI-Compliant System
IRQ 117	Microsoft ACPI-Compliant System
IRQ 118	Microsoft ACPI-Compliant System
IRQ 119	Microsoft ACPI-Compliant System
IRQ 120	Microsoft ACPI-Compliant System
IRQ 121	Microsoft ACPI-Compliant System
IRQ 122	Microsoft ACPI-Compliant System
IRQ 123	Microsoft ACPI-Compliant System
IRQ 124	Microsoft ACPI-Compliant System
IRQ 125	Microsoft ACPI-Compliant System
IRQ 126	Microsoft ACPI-Compliant System
IRQ 127	Microsoft ACPI-Compliant System
IRQ 128	Microsoft ACPI-Compliant System
IRQ 129	Microsoft ACPI-Compliant System
IRQ 130	Microsoft ACPI-Compliant System
IRQ 131	Microsoft ACPI-Compliant System
IRQ 132	Microsoft ACPI-Compliant System
IRQ 133	Microsoft ACPI-Compliant System
IRQ 134	Microsoft ACPI-Compliant System
IRQ 135	Microsoft ACPI-Compliant System
IRQ 136	Microsoft ACPI-Compliant System
IRQ 137	Microsoft ACPI-Compliant System
IRQ 138	Microsoft ACPI-Compliant System
IRQ 139	Microsoft ACPI-Compliant System
IRQ 140	Microsoft ACPI-Compliant System
IRQ 141	Microsoft ACPI-Compliant System
IRQ 142	Microsoft ACPI-Compliant System
IRQ 143	Microsoft ACPI-Compliant System
IRQ 144	Microsoft ACPI-Compliant System
IRQ 145	Microsoft ACPI-Compliant System
IRQ 146	Microsoft ACPI-Compliant System
IRQ 147	Microsoft ACPI-Compliant System
IRQ 148	Microsoft ACPI-Compliant System
IRQ 149	Microsoft ACPI-Compliant System

IRQ	ASSIGNMENT
IRQ 150	Microsoft ACPI-Compliant System
IRQ 151	Microsoft ACPI-Compliant System
IRQ 152	Microsoft ACPI-Compliant System
IRQ 153	Microsoft ACPI-Compliant System
IRQ 154	Microsoft ACPI-Compliant System
IRQ 155	Microsoft ACPI-Compliant System
IRQ 156	Microsoft ACPI-Compliant System
IRQ 157	Microsoft ACPI-Compliant System
IRQ 158	Microsoft ACPI-Compliant System
IRQ 159	Microsoft ACPI-Compliant System
IRQ 160	Microsoft ACPI-Compliant System
IRQ 161	Microsoft ACPI-Compliant System
IRQ 162	Microsoft ACPI-Compliant System
IRQ 163	Microsoft ACPI-Compliant System
IRQ 164	Microsoft ACPI-Compliant System
IRQ 165	Microsoft ACPI-Compliant System
IRQ 166	Microsoft ACPI-Compliant System
IRQ 167	Microsoft ACPI-Compliant System
IRQ 168	Microsoft ACPI-Compliant System
IRQ 169	Microsoft ACPI-Compliant System
IRQ 170	Microsoft ACPI-Compliant System
IRQ 171	Microsoft ACPI-Compliant System
IRQ 172	Microsoft ACPI-Compliant System
IRQ 173	Microsoft ACPI-Compliant System
IRQ 174	Microsoft ACPI-Compliant System
IRQ 175	Microsoft ACPI-Compliant System
IRQ 176	Microsoft ACPI-Compliant System
IRQ 177	Microsoft ACPI-Compliant System
IRQ 178	Microsoft ACPI-Compliant System
IRQ 179	Microsoft ACPI-Compliant System
IRQ 180	Microsoft ACPI-Compliant System
IRQ 181	Microsoft ACPI-Compliant System
IRQ 182	Microsoft ACPI-Compliant System
IRQ 183	Microsoft ACPI-Compliant System
IRQ 184	Microsoft ACPI-Compliant System
IRQ 185	Microsoft ACPI-Compliant System

IRQ	ASSIGNMENT
IRQ 186	Microsoft ACPI-Compliant System
IRQ 187	Microsoft ACPI-Compliant System
IRQ 188	Microsoft ACPI-Compliant System
IRQ 189	Microsoft ACPI-Compliant System
IRQ 190	Microsoft ACPI-Compliant System
IRQ 191	Microsoft ACPI-Compliant System
IRQ 192	Microsoft ACPI-Compliant System
IRQ 193	Microsoft ACPI-Compliant System
IRQ 194	Microsoft ACPI-Compliant System
IRQ 195	Microsoft ACPI-Compliant System
IRQ 196	Microsoft ACPI-Compliant System
IRQ 197	Microsoft ACPI-Compliant System
IRQ 198	Microsoft ACPI-Compliant System
IRQ 199	Microsoft ACPI-Compliant System
IRQ 200	Microsoft ACPI-Compliant System
IRQ 201	Microsoft ACPI-Compliant System
IRQ 202	Microsoft ACPI-Compliant System
IRQ 203	Microsoft ACPI-Compliant System
IRQ 204	Microsoft ACPI-Compliant System
IRQ 256	Microsoft ACPI-Compliant System
IRQ 257	Microsoft ACPI-Compliant System
IRQ 258	Microsoft ACPI-Compliant System
IRQ 259	Microsoft ACPI-Compliant System
IRQ 260	Microsoft ACPI-Compliant System
IRQ 261	Microsoft ACPI-Compliant System
IRQ 262	Microsoft ACPI-Compliant System
IRQ 263	Microsoft ACPI-Compliant System
IRQ 264	Microsoft ACPI-Compliant System
IRQ 265	Microsoft ACPI-Compliant System
IRQ 266	Microsoft ACPI-Compliant System
IRQ 267	Microsoft ACPI-Compliant System
IRQ 268	Microsoft ACPI-Compliant System
IRQ 269	Microsoft ACPI-Compliant System
IRQ 270	Microsoft ACPI-Compliant System
IRQ 271	Microsoft ACPI-Compliant System
IRQ 272	Microsoft ACPI-Compliant System

IRQ	ASSIGNMENT
IRQ 273	Microsoft ACPI-Compliant System
IRQ 274	Microsoft ACPI-Compliant System
IRQ 275	Microsoft ACPI-Compliant System
IRQ 276	Microsoft ACPI-Compliant System
IRQ 277	Microsoft ACPI-Compliant System
IRQ 278	Microsoft ACPI-Compliant System
IRQ 279	Microsoft ACPI-Compliant System
IRQ 280	Microsoft ACPI-Compliant System
IRQ 281	Microsoft ACPI-Compliant System
IRQ 282	Microsoft ACPI-Compliant System
IRQ 283	Microsoft ACPI-Compliant System
IRQ 284	Microsoft ACPI-Compliant System
IRQ 285	Microsoft ACPI-Compliant System
IRQ 286	Microsoft ACPI-Compliant System
IRQ 287	Microsoft ACPI-Compliant System
IRQ 288	Microsoft ACPI-Compliant System
IRQ 289	Microsoft ACPI-Compliant System
IRQ 290	Microsoft ACPI-Compliant System
IRQ 291	Microsoft ACPI-Compliant System
IRQ 292	Microsoft ACPI-Compliant System
IRQ 293	Microsoft ACPI-Compliant System
IRQ 294	Microsoft ACPI-Compliant System
IRQ 295	Microsoft ACPI-Compliant System
IRQ 296	Microsoft ACPI-Compliant System
IRQ 297	Microsoft ACPI-Compliant System
IRQ 298	Microsoft ACPI-Compliant System
IRQ 299	Microsoft ACPI-Compliant System
IRQ 300	Microsoft ACPI-Compliant System
IRQ 301	Microsoft ACPI-Compliant System
IRQ 302	Microsoft ACPI-Compliant System
IRQ 303	Microsoft ACPI-Compliant System
IRQ 304	Microsoft ACPI-Compliant System
IRQ 305	Microsoft ACPI-Compliant System
IRQ 306	Microsoft ACPI-Compliant System
IRQ 307	Microsoft ACPI-Compliant System
IRQ 308	Microsoft ACPI-Compliant System

IRQ	ASSIGNMENT
IRQ 309	Microsoft ACPI-Compliant System
IRQ 310	Microsoft ACPI-Compliant System
IRQ 311	Microsoft ACPI-Compliant System
IRQ 312	Microsoft ACPI-Compliant System
IRQ 313	Microsoft ACPI-Compliant System
IRQ 314	Microsoft ACPI-Compliant System
IRQ 315	Microsoft ACPI-Compliant System
IRQ 316	Microsoft ACPI-Compliant System
IRQ 317	Microsoft ACPI-Compliant System
IRQ 318	Microsoft ACPI-Compliant System
IRQ 319	Microsoft ACPI-Compliant System
IRQ 320	Microsoft ACPI-Compliant System
IRQ 321	Microsoft ACPI-Compliant System
IRQ 322	Microsoft ACPI-Compliant System
IRQ 323	Microsoft ACPI-Compliant System
IRQ 324	Microsoft ACPI-Compliant System
IRQ 325	Microsoft ACPI-Compliant System
IRQ 326	Microsoft ACPI-Compliant System
IRQ 327	Microsoft ACPI-Compliant System
IRQ 328	Microsoft ACPI-Compliant System
IRQ 329	Microsoft ACPI-Compliant System
IRQ 330	Microsoft ACPI-Compliant System
IRQ 331	Microsoft ACPI-Compliant System
IRQ 332	Microsoft ACPI-Compliant System
IRQ 333	Microsoft ACPI-Compliant System
IRQ 334	Microsoft ACPI-Compliant System
IRQ 335	Microsoft ACPI-Compliant System
IRQ 336	Microsoft ACPI-Compliant System
IRQ 337	Microsoft ACPI-Compliant System
IRQ 338	Microsoft ACPI-Compliant System
IRQ 339	Microsoft ACPI-Compliant System
IRQ 340	Microsoft ACPI-Compliant System
IRQ 341	Microsoft ACPI-Compliant System
IRQ 342	Microsoft ACPI-Compliant System
IRQ 343	Microsoft ACPI-Compliant System
IRQ 344	Microsoft ACPI-Compliant System

IRQ	ASSIGNMENT
IRQ 345	Microsoft ACPI-Compliant System
IRQ 346	Microsoft ACPI-Compliant System
IRQ 347	Microsoft ACPI-Compliant System
IRQ 348	Microsoft ACPI-Compliant System
IRQ 349	Microsoft ACPI-Compliant System
IRQ 350	Microsoft ACPI-Compliant System
IRQ 351	Microsoft ACPI-Compliant System
IRQ 352	Microsoft ACPI-Compliant System
IRQ 353	Microsoft ACPI-Compliant System
IRQ 354	Microsoft ACPI-Compliant System
IRQ 355	Microsoft ACPI-Compliant System
IRQ 356	Microsoft ACPI-Compliant System
IRQ 357	Microsoft ACPI-Compliant System
IRQ 358	Microsoft ACPI-Compliant System
IRQ 359	Microsoft ACPI-Compliant System
IRQ 360	Microsoft ACPI-Compliant System
IRQ 361	Microsoft ACPI-Compliant System
IRQ 362	Microsoft ACPI-Compliant System
IRQ 363	Microsoft ACPI-Compliant System
IRQ 364	Microsoft ACPI-Compliant System
IRQ 365	Microsoft ACPI-Compliant System
IRQ 366	Microsoft ACPI-Compliant System
IRQ 367	Microsoft ACPI-Compliant System
IRQ 368	Microsoft ACPI-Compliant System
IRQ 369	Microsoft ACPI-Compliant System
IRQ 370	Microsoft ACPI-Compliant System
IRQ 371	Microsoft ACPI-Compliant System
IRQ 372	Microsoft ACPI-Compliant System
IRQ 373	Microsoft ACPI-Compliant System
IRQ 374	Microsoft ACPI-Compliant System
IRQ 375	Microsoft ACPI-Compliant System
IRQ 376	Microsoft ACPI-Compliant System
IRQ 377	Microsoft ACPI-Compliant System
IRQ 378	Microsoft ACPI-Compliant System
IRQ 379	Microsoft ACPI-Compliant System
IRQ 380	Microsoft ACPI-Compliant System

IRQ	ASSIGNMENT
IRQ 381	Microsoft ACPI-Compliant System
IRQ 382	Microsoft ACPI-Compliant System
IRQ 383	Microsoft ACPI-Compliant System
IRQ 384	Microsoft ACPI-Compliant System
IRQ 385	Microsoft ACPI-Compliant System
IRQ 386	Microsoft ACPI-Compliant System
IRQ 387	Microsoft ACPI-Compliant System
IRQ 388	Microsoft ACPI-Compliant System
IRQ 389	Microsoft ACPI-Compliant System
IRQ 390	Microsoft ACPI-Compliant System
IRQ 391	Microsoft ACPI-Compliant System
IRQ 392	Microsoft ACPI-Compliant System
IRQ 393	Microsoft ACPI-Compliant System
IRQ 394	Microsoft ACPI-Compliant System
IRQ 395	Microsoft ACPI-Compliant System
IRQ 396	Microsoft ACPI-Compliant System
IRQ 397	Microsoft ACPI-Compliant System
IRQ 398	Microsoft ACPI-Compliant System
IRQ 399	Microsoft ACPI-Compliant System
IRQ 400	Microsoft ACPI-Compliant System
IRQ 401	Microsoft ACPI-Compliant System
IRQ 402	Microsoft ACPI-Compliant System
IRQ 403	Microsoft ACPI-Compliant System
IRQ 404	Microsoft ACPI-Compliant System
IRQ 405	Microsoft ACPI-Compliant System
IRQ 406	Microsoft ACPI-Compliant System
IRQ 407	Microsoft ACPI-Compliant System
IRQ 408	Microsoft ACPI-Compliant System
IRQ 409	Microsoft ACPI-Compliant System
IRQ 410	Microsoft ACPI-Compliant System
IRQ 411	Microsoft ACPI-Compliant System
IRQ 412	Microsoft ACPI-Compliant System
IRQ 413	Microsoft ACPI-Compliant System
IRQ 414	Microsoft ACPI-Compliant System
IRQ 415	Microsoft ACPI-Compliant System
IRQ 416	Microsoft ACPI-Compliant System

IRQ	ASSIGNMENT
IRQ 417	Microsoft ACPI-Compliant System
IRQ 418	Microsoft ACPI-Compliant System
IRQ 419	Microsoft ACPI-Compliant System
IRQ 420	Microsoft ACPI-Compliant System
IRQ 421	Microsoft ACPI-Compliant System
IRQ 422	Microsoft ACPI-Compliant System
IRQ 423	Microsoft ACPI-Compliant System
IRQ 424	Microsoft ACPI-Compliant System
IRQ 425	Microsoft ACPI-Compliant System
IRQ 426	Microsoft ACPI-Compliant System
IRQ 427	Microsoft ACPI-Compliant System
IRQ 428	Microsoft ACPI-Compliant System
IRQ 429	Microsoft ACPI-Compliant System
IRQ 430	Microsoft ACPI-Compliant System
IRQ 431	Microsoft ACPI-Compliant System
IRQ 432	Microsoft ACPI-Compliant System
IRQ 433	Microsoft ACPI-Compliant System
IRQ 434	Microsoft ACPI-Compliant System
IRQ 435	Microsoft ACPI-Compliant System
IRQ 436	Microsoft ACPI-Compliant System
IRQ 437	Microsoft ACPI-Compliant System
IRQ 438	Microsoft ACPI-Compliant System
IRQ 439	Microsoft ACPI-Compliant System
IRQ 440	Microsoft ACPI-Compliant System
IRQ 441	Microsoft ACPI-Compliant System
IRQ 442	Microsoft ACPI-Compliant System
IRQ 443	Microsoft ACPI-Compliant System
IRQ 444	Microsoft ACPI-Compliant System
IRQ 445	Microsoft ACPI-Compliant System
IRQ 446	Microsoft ACPI-Compliant System
IRQ 447	Microsoft ACPI-Compliant System
IRQ 448	Microsoft ACPI-Compliant System
IRQ 449	Microsoft ACPI-Compliant System
IRQ 450	Microsoft ACPI-Compliant System
IRQ 451	Microsoft ACPI-Compliant System
IRQ 452	Microsoft ACPI-Compliant System

IRQ	ASSIGNMENT
IRQ 453	Microsoft ACPI-Compliant System
IRQ 454	Microsoft ACPI-Compliant System
IRQ 455	Microsoft ACPI-Compliant System
IRQ 456	Microsoft ACPI-Compliant System
IRQ 457	Microsoft ACPI-Compliant System
IRQ 458	Microsoft ACPI-Compliant System
IRQ 459	Microsoft ACPI-Compliant System
IRQ 460	Microsoft ACPI-Compliant System
IRQ 461	Microsoft ACPI-Compliant System
IRQ 462	Microsoft ACPI-Compliant System
IRQ 463	Microsoft ACPI-Compliant System
IRQ 464	Microsoft ACPI-Compliant System
IRQ 465	Microsoft ACPI-Compliant System
IRQ 466	Microsoft ACPI-Compliant System
IRQ 467	Microsoft ACPI-Compliant System
IRQ 468	Microsoft ACPI-Compliant System
IRQ 469	Microsoft ACPI-Compliant System
IRQ 470	Microsoft ACPI-Compliant System
IRQ 471	Microsoft ACPI-Compliant System
IRQ 472	Microsoft ACPI-Compliant System
IRQ 473	Microsoft ACPI-Compliant System
IRQ 474	Microsoft ACPI-Compliant System
IRQ 475	Microsoft ACPI-Compliant System
IRQ 476	Microsoft ACPI-Compliant System
IRQ 477	Microsoft ACPI-Compliant System
IRQ 478	Microsoft ACPI-Compliant System
IRQ 479	Microsoft ACPI-Compliant System
IRQ 480	Microsoft ACPI-Compliant System
IRQ 481	Microsoft ACPI-Compliant System
IRQ 482	Microsoft ACPI-Compliant System
IRQ 483	Microsoft ACPI-Compliant System
IRQ 484	Microsoft ACPI-Compliant System
IRQ 485	Microsoft ACPI-Compliant System
IRQ 486	Microsoft ACPI-Compliant System
IRQ 487	Microsoft ACPI-Compliant System
IRQ 488	Microsoft ACPI-Compliant System

IRQ	ASSIGNMENT
IRQ 489	Microsoft ACPI-Compliant System
IRQ 490	Microsoft ACPI-Compliant System
IRQ 491	Microsoft ACPI-Compliant System
IRQ 492	Microsoft ACPI-Compliant System
IRQ 493	Microsoft ACPI-Compliant System
IRQ 494	Microsoft ACPI-Compliant System
IRQ 495	Microsoft ACPI-Compliant System
IRQ 496	Microsoft ACPI-Compliant System
IRQ 497	Microsoft ACPI-Compliant System
IRQ 498	Microsoft ACPI-Compliant System
IRQ 499	Microsoft ACPI-Compliant System
IRQ 500	Microsoft ACPI-Compliant System
IRQ 501	Microsoft ACPI-Compliant System
IRQ 502	Microsoft ACPI-Compliant System
IRQ 503	Microsoft ACPI-Compliant System
IRQ 504	Microsoft ACPI-Compliant System
IRQ 505	Microsoft ACPI-Compliant System
IRQ 506	Microsoft ACPI-Compliant System
IRQ 507	Microsoft ACPI-Compliant System
IRQ 508	Microsoft ACPI-Compliant System
IRQ 509	Microsoft ACPI-Compliant System
IRQ 510	Microsoft ACPI-Compliant System
IRQ 511	Microsoft ACPI-Compliant System
IRQ 1024	Intel SD Host Controller
IRQ 4294967277	Intel(R) HD Graphics
IRQ 4294967278	Intel(R) I210 Gigabit Network Connection #2
IRQ 4294967279	Intel(R) I210 Gigabit Network Connection #2
IRQ 4294967280	Intel(R) I210 Gigabit Network Connection #2
IRQ 4294967281	Intel(R) I210 Gigabit Network Connection #2
IRQ 4294967282	Intel(R) I210 Gigabit Network Connection #2
IRQ 4294967283	Intel(R) I210 Gigabit Network Connection #2
IRQ 4294967284	Intel(R) I210 Gigabit Network Connection
IRQ 4294967285	Intel(R) I210 Gigabit Network Connection
IRQ 4294967286	Intel(R) I210 Gigabit Network Connection
IRQ 4294967287	Intel(R) I210 Gigabit Network Connection
IRQ 4294967288	Intel(R) I210 Gigabit Network Connection

IRQ	ASSIGNMENT
IRQ 4294967289	Intel(R) I210 Gigabit Network Connection
IRQ 4294967290	Intel(R) USB 3.0 eXtensible Host Controller - 1.0 (Microsoft)
IRQ 4294967291	Intel(R) Trusted Execution Engine Interface
IRQ 4294967292	Standard SATA AHCI Controller
IRQ 4294967293	Intel(R) Celeron(R)/Pentium(R) Processor PCI Express Root Port - 5AD9
IRQ 4294967294	Intel(R) Celeron(R)/Pentium(R) Processor PCI Express Root Port - 5AD8

I/O MAP

I/O	ASSIGNMENT
0x00000A00-0x00000A0F	Motherboard resources
0x00000A10-0x00000A1F	Motherboard resources
0x00000A20-0x00000A2F	Motherboard resources
0x0000002E-0x0000002F	Motherboard resources
0x0000004E-0x0000004F	Motherboard resources
0x00000061-0x00000061	Motherboard resources
0x00000063-0x00000063	Motherboard resources
0x00000065-0x00000065	Motherboard resources
0x00000067-0x00000067	Motherboard resources
0x00000070-0x00000070	Motherboard resources
0x00000070-0x00000070	System CMOS/real time clock
0x00000080-0x0000008F	Motherboard resources
0x00000092-0x00000092	Motherboard resources
0x000000B2-0x000000B3	Motherboard resources
0x00000680-0x0000069F	Motherboard resources
0x00000400-0x0000047F	Motherboard resources
0x00000500-0x000005FE	Motherboard resources
0x00000600-0x0000061F	Motherboard resources
0x0000164E-0x0000164F	Motherboard resources
0x0000F040-0x0000F05F	Intel(R) Celeron(R)/Pentium(R) Processor SMBUS - 5AD4
0x0000D000-0x0000DFFF	Intel(R) Celeron(R)/Pentium(R) Processor PCI Express Root Port - 5AD9
0x000003F8-0x000003FF	Communications Port (COM1)
0x000002F8-0x000002FF	Communications Port (COM2)
0x0000F000-0x0000F03F	Intel(R) HD Graphics
0x0000E000-0x0000EFFF	Intel(R) Celeron(R)/Pentium(R) Processor PCI Express Root Port - 5AD8
0x00000000-0x0000006F	PCI Express Root Complex
0x00000078-0x00000CF7	PCI Express Root Complex
0x00000D00-0x0000FFFF	PCI Express Root Complex
0x00000020-0x00000021	Programmable interrupt controller
0x00000024-0x00000025	Programmable interrupt controller

I/O	ASSIGNMENT
0x00000028-0x00000029	Programmable interrupt controller
0x0000002C-0x0000002D	Programmable interrupt controller
0x00000030-0x00000031	Programmable interrupt controller
0x00000034-0x00000035	Programmable interrupt controller
0x00000038-0x00000039	Programmable interrupt controller
0x0000003C-0x0000003D	Programmable interrupt controller
0x000000A0-0x000000A1	Programmable interrupt controller
0x000000A4-0x000000A5	Programmable interrupt controller
0x000000A8-0x000000A9	Programmable interrupt controller
0x000000AC-0x000000AD	Programmable interrupt controller
0x000000B0-0x000000B1	Programmable interrupt controller
0x000000B4-0x000000B5	Programmable interrupt controller
0x000000B8-0x000000B9	Programmable interrupt controller
0x000000BC-0x000000BD	Programmable interrupt controller
0x000004D0-0x000004D1	Programmable interrupt controller
0x0000F090-0x0000F097	Standard SATA AHCI Controller
0x0000F080-0x0000F083	Standard SATA AHCI Controller
0x0000F060-0x0000F07F	Standard SATA AHCI Controller
0x00000040-0x00000043	System timer
0x00000050-0x00000053	System timer

Memory Map

MEMORY MAP	ASSIGNMENT
0xE0000000-0xEFFFFFFF	Motherboard resources
0xE0000000-0xEFFFFFFF	PCI Express Root Complex
0xFEAF0000-0xFEAFFFFF	Motherboard resources
0xFED01000-0xFED01FFF	Motherboard resources
0xFED03000-0xFED03FFF	Motherboard resources
0xFED06000-0xFED06FFF	Motherboard resources
0xFED08000-0xFED09FFF	Motherboard resources
0xFED80000-0xFEDBFFFF	Motherboard resources
0xFED1C000-0xFED1CFFF	Motherboard resources
0xFEE00000-0xFEEFFFFFFF	Motherboard resources
0x91310000-0x91313FFF	High Definition Audio Controller
0x91000000-0x910FFFFFFF	High Definition Audio Controller
0x91316000-0x913160FF	Intel(R) Celeron(R)/Pentium(R) Processor SMBUS - 5AD4
0x91180000-0x911FFFFFFF	Intel(R) I210 Gigabit Network Connection
0x9117C000-0x9117FFFF	Intel(R) I210 Gigabit Network Connection
0x91100000-0x911FFFFFFF	Intel(R) Celeron(R)/Pentium(R) Processor PCI Express Root Port - 5AD9
0x9131C000-0x9131CFFF	Intel(R) Serial IO I2C Host Controller - 5AB4
0x9131B000-0x9131BFFF	Intel(R) Serial IO I2C Host Controller - 5AB4
0xFED00000-0xFED003FF	High precision event timer
0x91300000-0x9130FFFF	Intel(R) USB 3.0 eXtensible Host Controller - 1.0 (Microsoft)
0x90000000-0x90FFFFFFF	Intel(R) HD Graphics
0x80000000-0x8FFFFFFF	Intel(R) HD Graphics
0x80000000-0x8FFFFFFF	PCI Express Root Complex
0x91200000-0x912FFFFFFF	Intel(R) Celeron(R)/Pentium(R) Processor PCI Express Root Port - 5AD8

MEMORY MAP	ASSIGNMENT
0x9131A000-0x9131AFFF	Intel(R) Serial IO I2C Host Controller - 5AB6
0x91319000-0x91319FFF	Intel(R) Serial IO I2C Host Controller - 5AB6
0x7C000001-0x7FFFFFFF	PCI Express Root Complex
0x7B800001-0x7BFFFFFF	PCI Express Root Complex
0x91321000-0x91321FFF	Intel(R) Trusted Execution Engine Interface
0xD0C00000-0xD0C00653	Intel(R) Serial IO GPIO Host Controller - INT3452
0xCFFF000-0xCFFFFFFF	Intel SD Host Controller
0xCFFE000-0xCFFEFFF	Intel SD Host Controller
0x91314000-0x91315FFF	Standard SATA AHCI Controller
0x9131E000-0x9131E0FF	Standard SATA AHCI Controller
0x9131D000-0x9131D7FF	Standard SATA AHCI Controller
0x91280000-0x912FFFFF	Intel(R) I210 Gigabit Network Connection #2
0x9127C000-0x9127FFFF	Intel(R) I210 Gigabit Network Connection #2

Configuring WatchDog Timer

The I/O port address of the watchdog timer is 2E (hex) and 2F (hex). 2E (hex) is the address port. 2F (hex) is the data port. User must first assign the address of register by writing address value into address port 2E (hex), then write/read data to/from the assigned register through data port 2F (hex).

Configuration Sequence

To program F81946 configuration registers, the following configuration sequence must be followed:

(1) Enter the extended function mode

To place the chip into the Extended Function Mode, two successive writes of 0x87 must be applied to Extended Function Enable Registers (EFERs, i.e. 2Eh or 4Eh).

(2) Configure the configuration registers

The chip selects the Logical Device and activates the desired Logical Devices through Extended Function Index Register (EFIR) and Extended Function Data Register (EFDR). The EFIR is located at the same address as the EFER, and the EFDR is located at address (EFIR+1). First, write the Logical Device Number (i.e. 0x07) to the EFIR and then write the number of the desired Logical Device to the EFDR. If accessing the Chip (Global) Control Registers, this step is not required. Secondly, write the address of the desired configuration register within the Logical Device to the EFIR and then write (or read) the desired configuration register through the EFDR.

(3) Exit the extended function mode

To exit the Extended Function Mode, writing 0xAA to the EFER is required. Once the chip exits the Extended Function Mode, it is in the normal running mode and is ready to enter the configuration mode.

Code example for watch dog timer

Enable watchdog timer and set timeout interval to 30 seconds.

```
;----- Enter extended function mode -----  
mov  dx,    2eh  
mov  al,    87h  
out  dx,    al  
out  dx,    al  
;  
;----- Select Logical Device 7 of watchdog timer -----  
mov  al,    07h  
out  dx,    al  
inc  dx  
mov  al,    07h  
out  dx,    al  
;  
;----- Enable Watch dog feature -----  
mov  al,    030h  
out  dx,    al  
inc  dx  
mov  al,    01h  
out  dx,    al  
;  
;----- Enable Watch PME-----  
dec  dx  
mov  al,    0FAh  
out  dx,    al  
inc  dx  
in   al,    dx  
and  al,    51h  
out  dx,    al  
;  
;----- Set timeout interval to 30 -----  
dec  dx  
mov  al,    0F6h  
out  dx,    al  
inc  dx  
mov  al,    1Eh  
out  dx,    al  
;  
;----- Set second as counting unit and start counting -----  
dec  dx  
mov  al,    0F5h
```

```
out dx, al
inc dx
in al, dx
and al, 30h
out dx, al
```

```
;-----Exit the extended function mode-----
```

```
dec dx
mov al, 0AAh
out dx, al
```

Flash BIOS Update

I. Prerequisites

- 1** Prepare a USB storage device which can save the required files for BIOS update.
- 2** Download and save the BIOS file (e.g. 655X0TM0.bin) to the storage device.
- 3** Copy AMI flash utility – AFUEFIx64.exe (v5.09.01) into the storage device. The utility and BIOS file should be saved to the same path.
- 4** Make sure the target system can first boot to the EFI shell environment.
 - (1) Connect the USB storage device.
 - (2) Turn on the computer and press <ESC> or key during boot to enter BIOS Setup.
 - (3) Select [**Boot**] menu and set [**UEFI: Built-in EFI Shell**] as the 1st boot device.
 - (4) Press <F4> key to save configuration and restart the system to boot into EFI Shell environment.

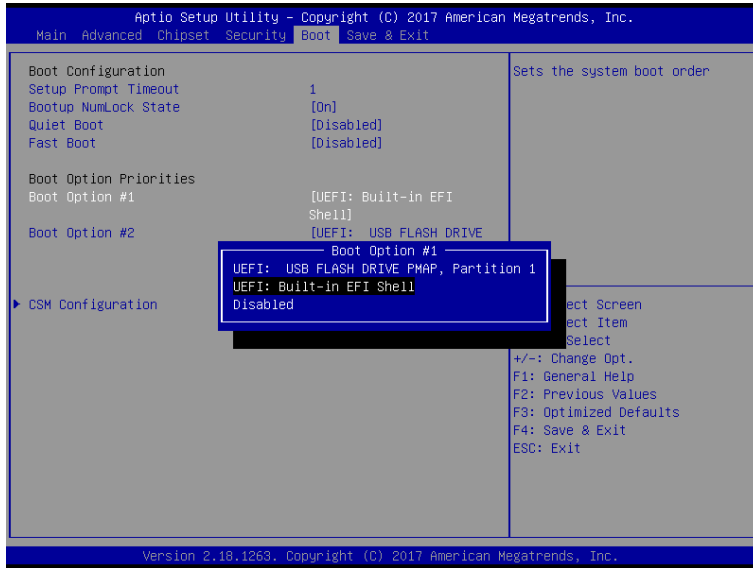

AFUEFIx64 command for system BIOS update

AFUEFIx64.efi is the AMI firmware update utility; the command line is shown as below:

AFUEFIx64 <ROM File Name> [option1] [option2]....

Users can type “AFUEFIx64 /?” to see the definition of each control option. The recommended options for BIOS ROM update include the following parameters:

- /P:** Program main BIOS image.
- /B:** Program Boot Block.
- /N:** Program NVRAM.
- /X:** Don't check ROM ID.

II. BIOS Update Procedure

1 Boot into EFI Shell, change to the path where you put BIOS image and AFUEFIx64.

```
Shell> fs0:  
fs0:\> cd afuefix64
```

2 Type "AFUEFIx64 655Xxxxx.bin /p /b /n /x" and press Enter to start the flash procedure.

(Note that xxxx means the BIOS revision part, e.g. 0PM1...)

3 During the BIOS update procedure, you will see the BIOS update process status and its execution percentage. Beware! Do not turn off the system power or reset your computer when the entire update procedure are not complete; otherwise, the BIOS ROM may be crashed and the system will be unable to boot up next time.

- 4 After the BIOS update procedure is completed, the following messages will be shown:

```
fs0:\afuefix64> afuefix64 655X0TM0.bin /p /b /n /x
+-----+
|               AMI Firmware Update Utility  v5.09.01.1317               |
|   Copyright (C) 2016 American Megatrends Inc. All Rights Reserved.   |
+-----+
Reading flash ..... done
- ME Data Size Checking . ok
- FFS checksums ..... ok
- Check RomLayout ..... Ok.
Erasing Boot Block ..... done
Updating Boot Block ..... done
Verifying Boot Block ..... done
Erasing Main Block ..... done
Updating Main Block ..... done
Verifying Main Block ..... done
Erasing NVRAM Block ..... done
Updating NVRAM Block ..... done
Verifying NVRAM Block ..... done
fs0:\afuefix64> _
```

- 5 Restart the system and boot up with the new BIOS configurations.
- 6 The BIOS Update is completed after the system is restarted.
- 7 Reboot the system and verify if the BIOS version shown on the initialization screen has been updated.

